

MILLING TOOLS



About GESAC

Xiamen Golden Egret Special Alloy Co., Ltd. (GESAC) is a Sino-foreign joint venture company established in 1989. It is designated by the State as a high-tech enterprise. GESAC is the largest subsidiary of the Shanghai Stock Exchange listed company: Xiamen Tunsten Co., LTD. (Stock code: SH600549) Its main products are tungsten metal powder, tungsten carbide powder, cemented carbide, cutting tools and other tungsten related products. GESAC is the largest producer and exporter of tungsten metal powder and tungsten carbide powder in China and also enjoys good reputation in manufacturing high quality cemented carbide and precision cutting tools.

GESAC has a team of talented staff constantly striving to be stronger. GESAC is equipped with the world's most advanced technologies, manufacturing equipment and testing facilities. The "Golden Egret" brand products are renowned for high quality and excellent service. Our clients are spread across more than forty developed countries and regions all over the world.

GESAC owns a national level R&D center, and has undertaken and finished many national and provincial research projects independently, such as National Science and Technology Support Plan project, National major special science and technology project, National Key Technologies R&D Program, National Torch Program, National Important New Products project etc. GESAC has received numerous awards such as "National Standard High-tech Enterprise", "Enterprise with Advanced Technology" and "Export-oriented Enterprise" from the state government.

GESAC adheres to the philosophy of "sincerity and dependability are our essence" and strives to develop into a modern enterprise with "first class equipment, first class technology, first class management, first class quality and first class service".



Product Chain

GESAC has a complete tungsten product chain from tungsten ore to tungsten powder, cemented carbide products and cutting tools.

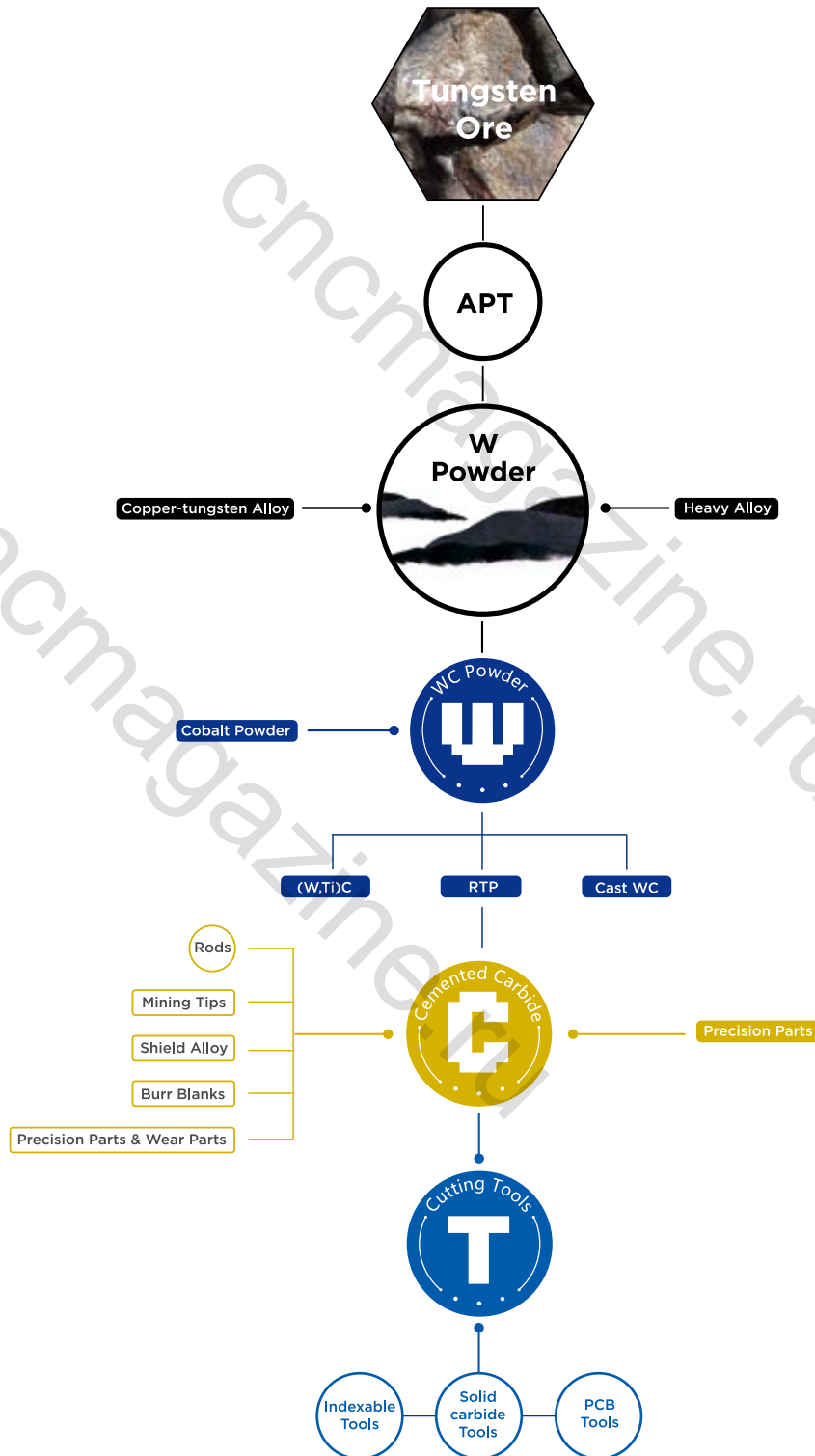

Contents

Indexable Milling — A

Indexable Insert Identification System	002
Indexable Milling Product Lineup	006
Milling Grades	014
Pitch Type and the number of cutting Edges	018
Indexable Milling	019
Face Milling •	019
Shoulder Milling •	046
Profile Milling •	052
High Feed Milling •	070
Side and Face Milling •	081
Chamfer Milling •	088
Application Case	091

Solid Carbide Endmills — B

GESAC Coating	094
Guidelines to Icons	097
Solid Carbide Endmills Identify System	098
Small & Cavity Endmills Identify System	100
Application Summary	102
Series Introduction & Endmills Index	103
Solid Carbide Endmills	150
Square •	150
Corner Radius •	245
Ballnose •	342
Small & Cavity Milling •	383
Application Case	415
Recommended Cutting Datas	421

Appendix — C

Cutting Parameters and General Formula	514
Workpiece Material Table	515
The Structure of Shank	516
Comparison Table for Hardness	517

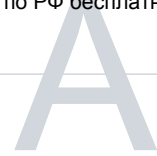

INDEXABLE MILLING



ISO Milling Indexable Inserts Identification System

Symbol	Shape	Comer Angle	Figure
H	Hexagon	120°	
O	Octagon	135°	
P	Pentagon	108°	
S	Square	90°	
T	Triangle	60°	
C	Rhombic	80°	
D		55°	
E		75°	
F		50°	
M		86°	
V		35°	
W	Trigon	80°	
L	Rectangle	90°	
A	Parellelogram	85°	
B		82°	
K		55°	
R	Round	—	

①Shape Symbol

Symbol	Relief Angle
A	3°
B	5°
C	7°
D	15°
E	20°
F	25°
G	30°
N	0°
P	11°
O	Others



②Relief Angle Symbol

Symbol	Tolerance (mm)			Tolerance (inch)		
	Corner Height(m)	Thickness(s)	I.C.Size (Ød)	Corner Height(m)	Thickness(s)	I.C.Size (Ød)
A	±0.005	±0.025	±0.025	±0.0002	±0.001	±0.001
F	±0.005	±0.025	±0.013	±0.0002	±0.001	±0.0005
C	±0.013	±0.025	±0.025	±0.0005	±0.001	±0.001
H	±0.013	±0.025	±0.013	±0.0005	±0.001	±0.0005
E	±0.025	±0.025	±0.025	±0.001	±0.001	±0.001
G	±0.025	±0.13	±0.025	±0.001	±0.005	±0.001
J	±0.005	±0.025	±0.05~±0.13	±0.0002	±0.001	±0.002~±0.005
K	±0.013	±0.025	±0.05~±0.13	±0.0005	±0.001	±0.002~±0.005
L	±0.025	±0.025	±0.05~±0.13	±0.001	±0.001	±0.002~±0.005
M	±0.08~±0.18	±0.13	±0.05~±0.13	±0.003~±0.007	±0.005	±0.002~±0.005
N	±0.08~±0.18	±0.025	±0.05~±0.13	±0.003~±0.007	±0.001	±0.002~±0.005
U	±0.13~±0.38	±0.13	±0.08~±0.25	±0.005~±0.015	±0.005	±0.003~±0.01

③Tolerance Symbol

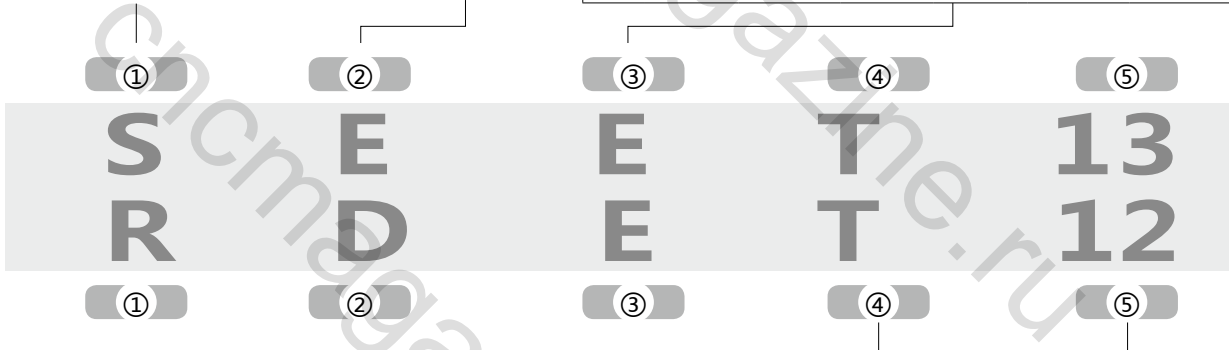

④Chipbreaker /Hole Symbol				
Symbol	Hole	Hole Shape	Chipbreaker	Shape
N	Without	—	Without	
R			Single-sided	
F			Double-sided	
A	With Hole	With Hole	Without	
M			Single-sided	
G			Double-sided	
W	With hole and one countersink 40°~60°	With hole and one countersink 40°~60°	Without	
T			Single-sided	
Q	With hole and two countersinks 40°~60°	With hole and two countersinks 40°~60°	Without	
U			Double-sided	
B	With hole and one countersink 70°~90°	With hole and one countersink 70°~90°	Without	
H			Single-sided	
C	With hole and two countersinks 70°~90°	With hole and two countersinks 70°~90°	Without	
J			Double-sided	
X	—	—	—	

⑤Cutting Edge Length Symbol(ISO)(mm)																		
Symbol	Length	P		S		C		W		T		D		V		K		I.C.Size (mm)
		Symbol	Length	Symbol	Length	Symbol	Length	Symbol	Length	Symbol	Length	Symbol	Length	Symbol	Length	Symbol	Length	
				03	3.97	03	4.0			06	6.9	4	4.8					3.97
				04	4.76	04	4.8			08	8.2	5	5.8					4.76
05	5																	5
				05	5.56	05	5.6	03	3.8	09	9.6	6	6.8					5.56
06	6																	6
				06	6.35	06	6.5	04	4.3	11	11	7	7.8	11	11.2			6.35
				07	7.94	08	8.1	05	5.4	13	13.8	9	9.7					7.94
08	8																	8
09	9.525			09	9.525	09	9.7	06	6.5	16	16.5	11	11.6	16	16.6	16	19.7	9.525
10	10																	10
12	12																	12
12	12.7			12	12.7	12	12.9	08	8.7	22	22	15	15.5	22	22.1			12.7
15	15.875			15	15.875	16	16.1	10	10.9	27	27.5	19	19.4					15.875
16	16																	16
19	19.05			19	19.05	19	19.3	13	13	33	33	23	23.3					19.05
20	20																	20
				22	22.225	22	22.6			38	38.5	27	27.1					22.225
25	25																	25
25	25.4			25	25.4	25	25.8			44	44	31	31					25.4
31	31.75			31	31.75	32	32.2			55	55	38	38.8					31.75
31	32																	32

Insert Shape:H,O,P,S,T,C,E,M,W,R									
I.C. Size (mm)	Tolerance of I.C.Size(Ød) (mm)		Tolerance of Corner Height(m)(mm)		I.C. Size (inch)	Tolerance of I.C. Size(Ød) (mm)		Tolerance of Corner Height(m)(mm)	
	Class J,K,L,M,N	Class U	Class J,K,L,M,N	Class U		Class J,K,L,M,N	Class U	Class J,K,L,M,N	Class U
6.35	±0.05	±0.08	±0.08	±0.13	0.250	±0.002	±0.003	±0.003	±0.005
9.525					0.375				
12.7	±0.08	±0.13	±0.13	±0.2	0.500	±0.003	±0.005	±0.005	±0.008
15.875					0.625				
19.05	±0.1	±0.18	±0.15	±0.27	0.750	±0.004	±0.007	±0.006	±0.011
25.4					1.000				
31.75	±0.15	±0.25	±0.18	±0.38	1.250	±0.005	±0.010	±0.007	±0.015
32					1.260				

Symbol	Thickness (mm)
01	1.59
T1	1.98
02	2.38
T2	2.78
03	3.18
T3	3.97
04	4.76
05	5.56
06	6.35
07	7.94
09	9.52
Thickness Symbol	

Insert Shape: D					
Inscribed Circle Size		Tolerance of I.C. Size		Tolerance of Corner Height	
mm	in	mm	in	mm	in
6.35	0.250	±0.05	±0.002	±0.11	±0.004
9.525	0.375	±0.05	±0.002	±0.11	±0.004
12.7	0.500	±0.08	±0.003	±0.15	±0.006
15.875	0.625	±0.10	±0.004	±0.18	±0.007
19.05	0.750	±0.10	±0.004	±0.18	±0.007

Insert Shape: V					
Inscribed Circle Size		Tolerance of I.C. Size		Tolerance of Corner Height	
mm	in	mm	in	mm	in
6.35	0.250	±0.05	±0.002	±0.15	±0.006
9.525	0.375	±0.05	±0.002	±0.15	±0.006
12.7	0.500	±0.08	±0.003	±0.20	±0.008
15.875	0.625	±0.10	±0.004	±0.27	±0.011
19.05	0.750	±0.10	±0.004	±0.27	±0.011

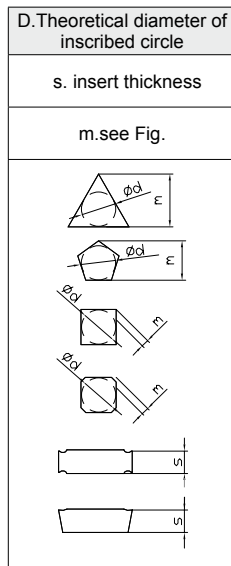
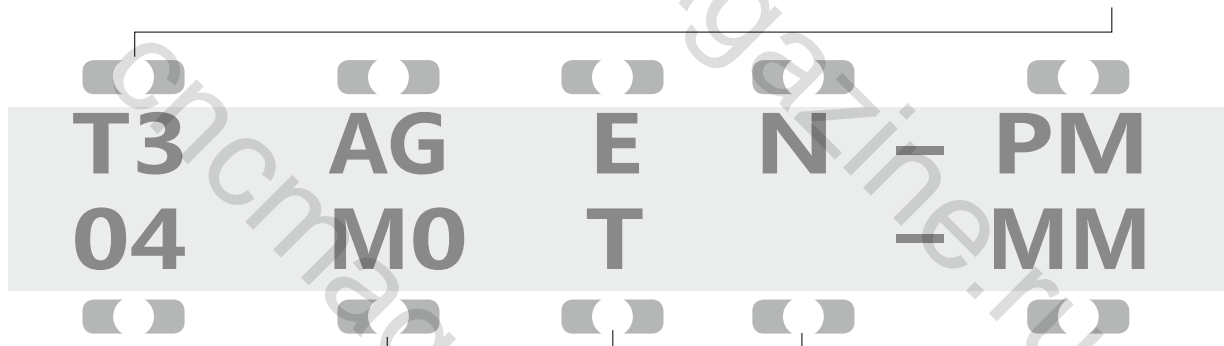

⑦ Wiper Angle or Nose Radius						
I						
Symbol	Approach Angle	Cutting Edge Angle	Symbol	Relief Angle of Wiper	Symbol	Corner-R _e (mm)
A	45°	45°	D	15°	00	0.03
D	30°	60°	E	20°	02	0.2
E	15°	75°	F	25°	04	0.4
F	5°	85°	G	30°	08	0.8
P	0°	90°	P	11°	12	1.2
Z	Others		Z	Others	16	1.6
Wiper						
WA	Linear		A		28	2.8
WB	Largearc-shaped		B		32	3.2
WC	Convexarc-shaped		C		Nose Radius for Insert	
WZ	Others				○ 00 Inch Size ○ M0 Metric Size	

⑧ Major cutting edge		
Symbol	Description	Shape
F	Sharp Edge	
E	R-Honed	
T	Chamfer	
S	Chamfer and R-Honed	

⑩ Chipbreaker Symbol	
Symbol	Machining Condition
PL	Light Cutting for Steel
PM	Medium Cutting for Steel
PR	Rough Cutting for Steel
KM	Medium Cutting for Cast Iron
KR	Rough Cutting for Cast Iron
MM	Medium Cutting for Stainless Steel

Detailed Reference : Designation System for Milling Chipbreaker

⑨ Direction	
Symbol	Hand
R	Right
L	Left
N	Neutral



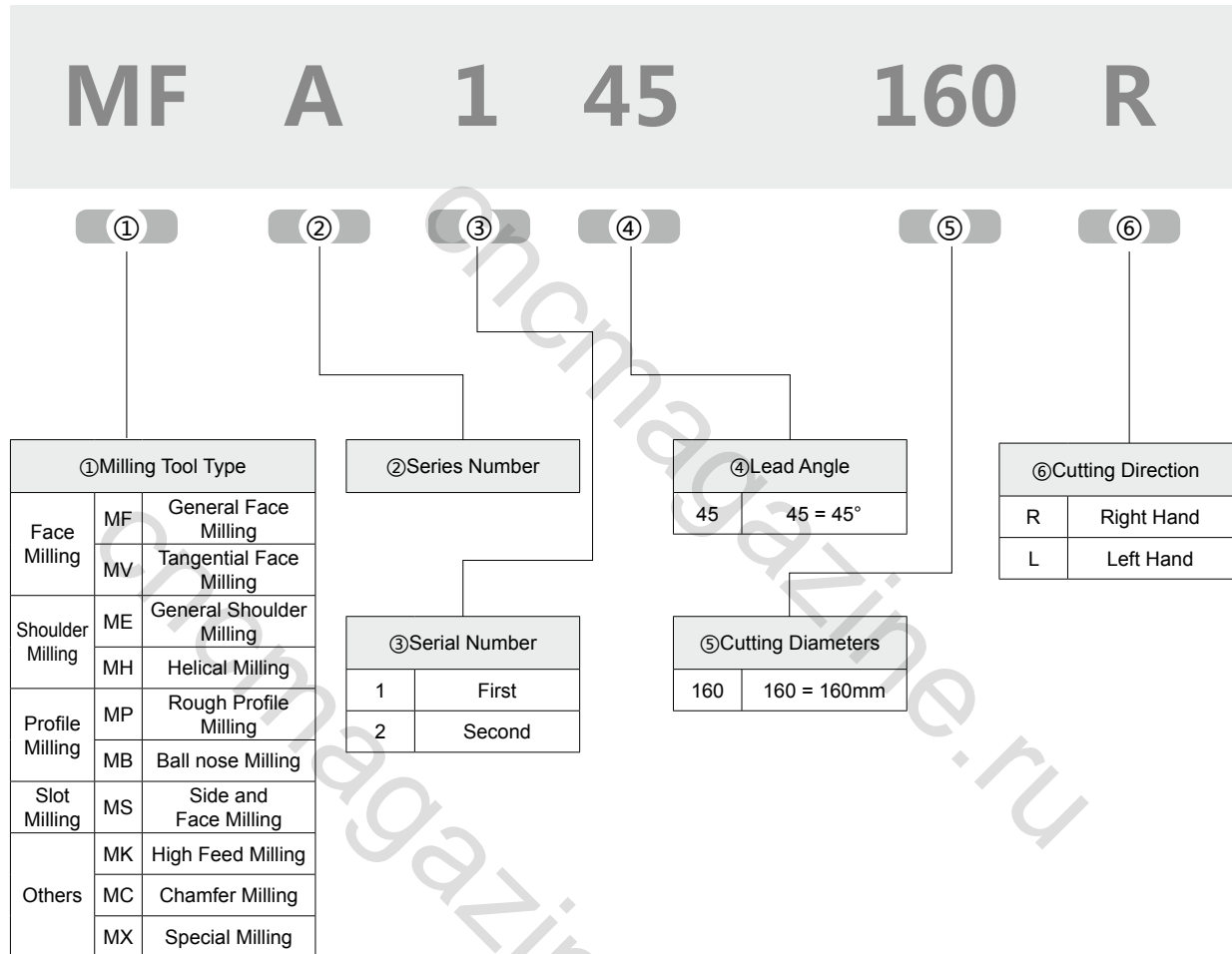

Milling Toos Identification System

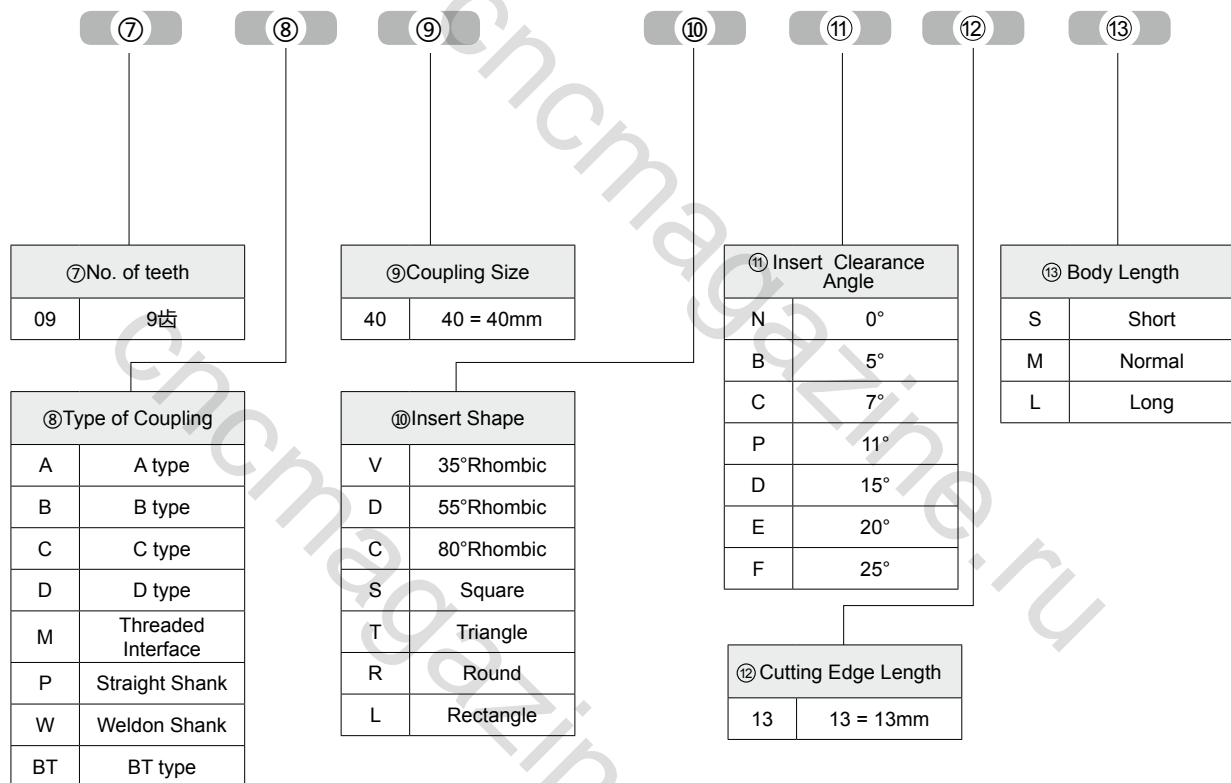



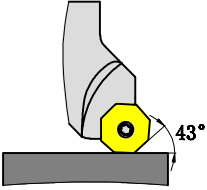

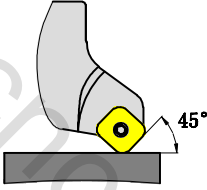
09 C 40 S E 13 (M)

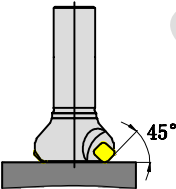
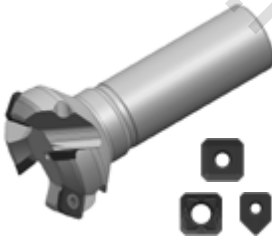
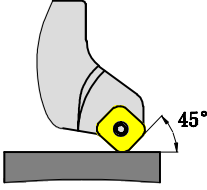
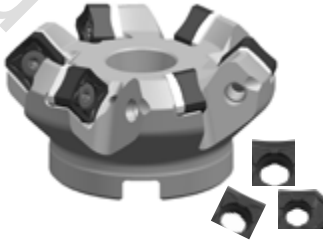



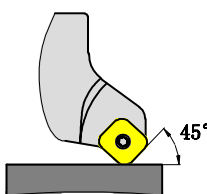
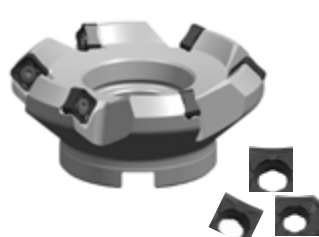
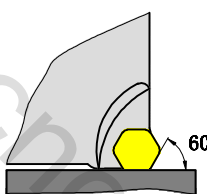

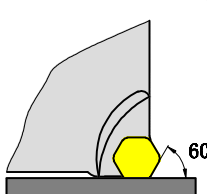
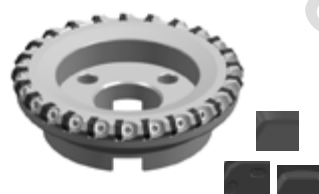
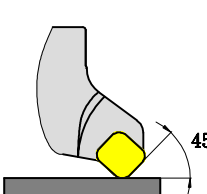

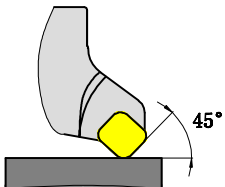

Indexable Milling Product Lineup

Type	Approach Angle	Insert	Cutter	Shape	Profile
Face Milling	 <p>OD06:ap_{max}=4.0mm</p>	OD*T P019	MFA143 (Φ40-Φ200)		Smoothly cutting with universal property , specially suit for efficiency face milling for connection face of mechanical components with different material
	 <p>SE13:ap_{max}=6.0mm</p>	SE*T	MFA145 (Φ50-Φ125)		Smoothly cutting with universal property , specially suit for efficiency face milling for connection face of mechanical components with different material
	 <p>SE13:ap_{max}=6.0mm</p>		MFA145 (Φ50-Φ63) P023		
	 <p>SN12:ap_{max}=5.0mm</p>	SN*U P028	MFB145 (Φ50-Φ315)		Smoothly cutting with universal property , specially suit for efficiency face milling for connection face of mechanical components with different material

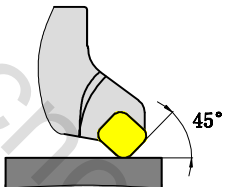

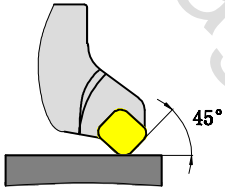

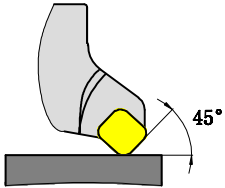

Indexable Milling Product Lineup

Type	Approach Angle	Insert	Cutter	Shape	Profile
Face Milling	 <p>SN12:ap_{max}=5.0mm</p>	SN*U P028	MFB245 (Φ50-Φ315)		Smoothly cutting with universal property, specially suit for efficiency face milling for connection face of mechanical components with different material
	 <p>HN09:ap_{max}=8.0mm</p>	HN*X	MFB160 (Φ125-Φ315)		Efficiency and economically face milling specially for cast iron
	 <p>HN09:ap_{max}=8.0mm</p>		MFB260 (Φ80-Φ315)		
	 <p>SB12:ap_{max}=5.0mm</p>	SBEX P039	-		Smoothly cutting with universal property, specially suit for efficiency face milling for connection face of mechanical components with different material

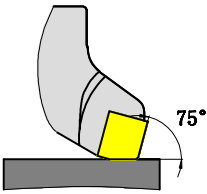

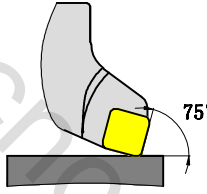
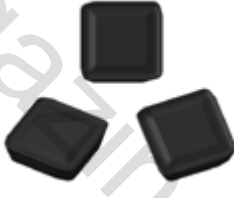
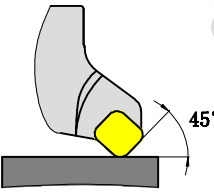

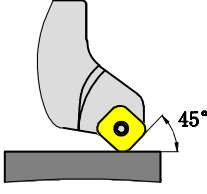

Indexable Milling Product Lineup

Type	Approach Angle	Insert	Cutter	Shape	Profile
Face Milling	 <p>SE12: $a_{p_{max}}=5.0\text{mm}$ SE15: $a_{p_{max}}=6.5\text{mm}$</p>	<p>SEEN SEMN SEEX</p> <p>P039</p>	-		Smoothly cutting with universal property, specially suit for efficiency face milling for connection face of mechanical components with different material
	 <p>SE12: $a_{p_{max}}=5.0\text{mm}$</p>	<p>SEEN-R</p> <p>P040</p>	-		
	 <p>SP15: $a_{p_{max}}=6.5\text{mm}$ SP19: $a_{p_{max}}=8.0\text{mm}$ SP25: $a_{p_{max}}=10.0\text{mm}$</p>	<p>SPEN</p> <p>P040</p>	-		
	 <p>SP12: $a_{p_{max}}=9.5\text{mm}$ SP15: $a_{p_{max}}=11.5\text{mm}$ SP19: $a_{p_{max}}=14.0\text{mm}$</p>	<p>SPKN</p> <p>P041</p>	-		

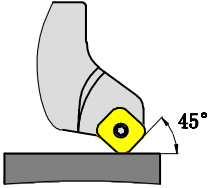

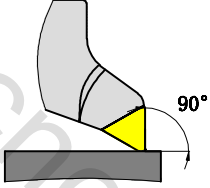

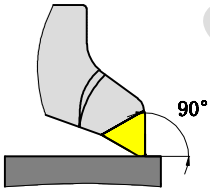

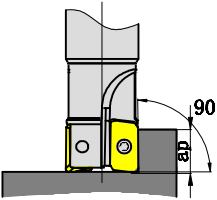
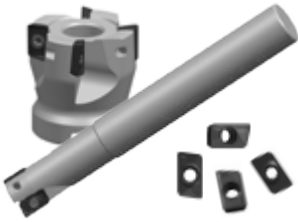
Indexable Milling Product Lineup

Type	Approach Angle	Insert	Cutter	Shape	Profile
Face Milling	 <p>SP15: $a_{p_{max}}=11.5\text{mm}$</p>	SPEN-W P041	-		Smoothly cutting with universal property, specially suit for efficiency face milling for connection face of mechanical components with different material
	 <p>SP12: $a_{p_{max}}=9.5\text{mm}$</p>	SPER P042	-		
	 <p>SP15: $a_{p_{max}}=6.5\text{mm}$</p>	SPNR P042	-		
	 <p> SP09: $a_{p_{max}}=3.5\text{mm}$ SP12: $a_{p_{max}}=5.0\text{mm}$ SP15: $a_{p_{max}}=6.5\text{mm}$ </p>	SPCW P043	-		

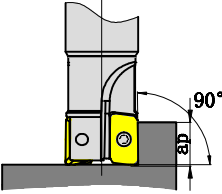

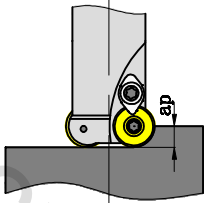
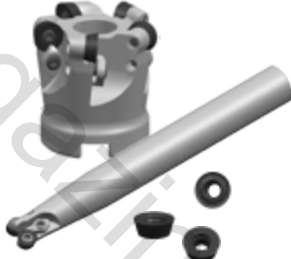
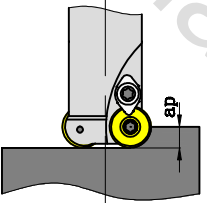

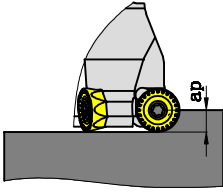
Indexable Milling Product Lineup

Type	Approach Angle	Insert	Cutter	Shape	Profile
Face Milling	 <p>SP12:ap_{max}=5.0mm</p>	<p>SPKT</p> <p>P043</p>	-		<p>Smoothly cutting with universal property, specially suit for efficiency face milling for connection face of mechanical components with different material</p>
	 <p>TP16:ap_{max}=22.0mm TP22:ap_{max}=30.0mm</p>	<p>TPER TPKR TPKN</p> <p>P044</p>	-		
	 <p>TP22:ap_{max}=30.0mm</p>	<p>TPNR</p> <p>P045</p>	-		
Shoulder Milling	 <p>AP16:ap_{max}=14.0mm AP11:ap_{max}=9.0mm</p>	<p>APM(GT)</p> <p>P046</p>	<p>MEA190 (Φ16-Φ250)</p>		<p>Suitable for the cutting of steel, cast iron and stainless steel, mainly used for shoulder milling, face milling, pocket milling, slot milling etc.</p>

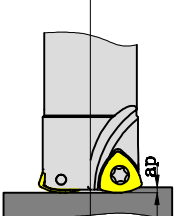

Indexable Milling Product Lineup

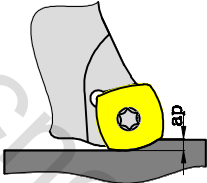
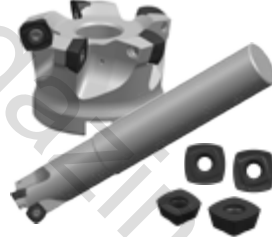
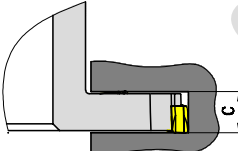
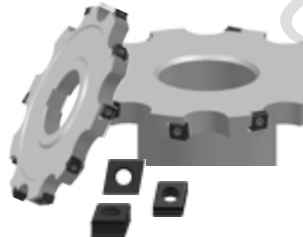
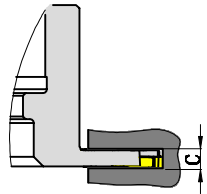
Type	Approach Angle	Insert	Cutter	Shape	Profile
Shoulder Milling	 <p>XP16:ap_{max}=14.0mm</p>	XPHT P051	-		Suitable for the cutting of steel, cast iron and stainless steel, mainly used for shoulder milling, face milling, pocket milling, slot milling etc.
	 <p>RD05:ap_{max}=2.5 mm RD07:ap_{max}=3.5 mm RD08:ap_{max}=4.0 mm RD10:ap_{max}=5.0 mm RD12:ap_{max}=6.0 mm RD16:ap_{max}=8.0 mm</p>	RD P052	MPA100 (Φ10-Φ125)		Suitable for the cutting of steel, cast iron and stainless steel, mainly used for shoulder milling, face milling, pocket milling, slot milling etc.
Shoulder Milling	 <p>RP08:ap_{max}=4.0 mm RP10:ap_{max}=5.0 mm RP12:ap_{max}=6.0 mm RP16:ap_{max}=8.0 mm</p>	RP P057	MPB100 (Φ16-Φ125)		Suitable for the cutting of steel, cast iron and stainless steel, mainly used for shoulder milling, face milling, pocket milling, slot milling etc.
	 <p>RC10:ap_{max}=5.0 mm RC12:ap_{max}=6.0 mm RC16:ap_{max}=8.0 mm RC20:ap_{max}=10.0 mm</p>	RC P062	MPC100 (Φ20-Φ125)		Suitable for the cutting of steel, cast iron and stainless steel, mainly used for shoulder milling, face milling, pocket milling, slot milling etc.

Indexable Milling Product Lineup

Type	Approach Angle	Insert	Cutter	Shape	Profile
High Feed Milling	 <p>UD08: $a_{p_{max}}=1.0\text{mm}$ UD12: $a_{p_{max}}=1.5\text{mm}$ UP17: $a_{p_{max}}=2.0\text{mm}$</p>	UD/UP P070	MKA110 ($\Phi 20-\Phi 100$)		Suitable for the cutting of steel, castiron and stainless steel, mainly used for face milling and pocket milling
	 <p>SD12: $a_{p_{max}}=2.0\text{mm}$ SD15: $a_{p_{max}}=3.0\text{mm}$</p>	SDMT P076	MKB113 ($\Phi 32-\Phi 125$)		Suitable for the cutting of steel, castiron and stainless steel, mainly used for face milling and pocket milling
Slot Milling	 <p>$C_{max}=13.0\text{mm}$ $C_{min}=10.0\text{mm}$</p>	CNEU P081	MSA110-MSA113 ($\Phi 80-\Phi 160$)		Suitable for the cutting of steel, castiron and stainless steel, mainly used for face milling and pocket milling
	 <p>$C_{max}=8.0\text{mm}$ $C_{min}=4.0\text{mm}$</p>	SNEX P085	MSA104-108 ($\Phi 100$)		Mainly used for steel, cast iron, suitable for automobile and aviation industry.

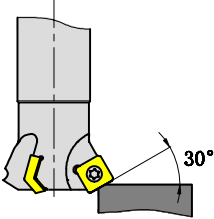
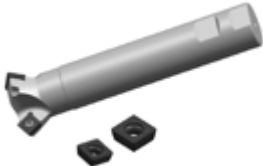
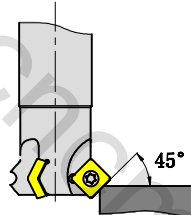
Indexable Milling Product Lineup

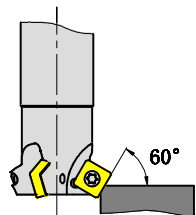
Type	Approach Angle	Insert	Cutter	Shape	Profile
Chamfer milling	 <p>SP09: $a_{p_{max}}=3.0\text{mm}$ SP12: $a_{p_{max}}=4.5\text{mm}$</p>	SPMT	MCA130 ($\Phi 25-\Phi 32$)		Suitable for the cutting of steel, stainless steel and heat-resisting alloy, mainly used for chamfer milling.
	 <p>SP09: $a_{p_{max}}=5.0\text{mm}$ SP12: $a_{p_{max}}=7.0\text{mm}$</p>		MCA145 ($\Phi 25-\Phi 32$)		
	 <p>SP09: $a_{p_{max}}=6.0\text{mm}$ SP12: $a_{p_{max}}=8.0\text{mm}$</p>		P088	MCA160 ($\Phi 25-\Phi 32$)	

Milling Insert Grades

(1) Grades For P Applications

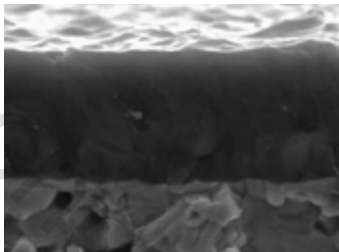
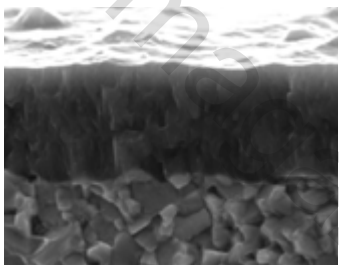
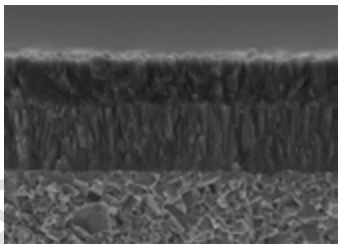
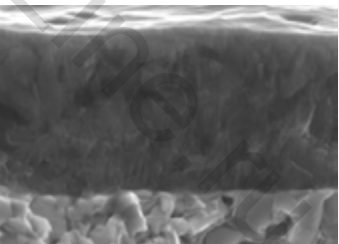
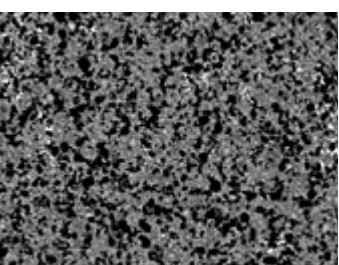
Grade	Application	Coating Structure	Advantages
GA4230	General Milling with Medium Load		The new upgrade TiAlN+ coating has excellent heat resistance and oxidation resistance. Application: Due to the high adhesion strength to the cemented carbide substrate with high wear resistance and damage resistance, GA4230 can achieve stable processing under different cutting conditions.
GA4225	General Milling with Medium Load		Nano-structure AlCrN coating combined with micro-grained cemented carbide substrate. Application: Suitable for medium to low speed milling of steel and cast iron materials and etc.
GP2115	Semi-finishing		Medium-thick MT-TiCN+Al ₂ O ₃ coating combined with fine grained cemented carbide substrate, has superior toughness and great wear resistance. Application: Suitable for finishing to semi-finishing from medium to high speed milling of steel.
GP4225	Semi-finishing and Roughing		The new upgrade AlCrN+TiN coating combined with micro-grained cemented carbide substrate, has great wear resistance. Application: Suitable for semi-finishing to light roughing of steel.
GP01TM	Finishing and Semi-finishing		Uncoated metal ceramic milling grade has excellent wear resistance, toughness and chipping resistance. Application: General milling processing of all types of material, especially for steel.

Milling Insert Grades

(2) Grades for M Applications

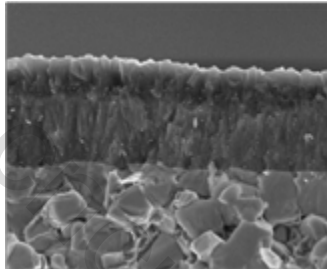
Grade	Application	Coating Structure	Advantages
GM2140	Roughing		The new upgrade MT-TiCN+Al ₂ O ₃ coating combined with fine grained cemented carbide substrate with high strength has great wear resistance, superior toughness and thermal stability. Application: Suitable for semi-finishing and rough milling of stainless steel and high-temperature heat resistant alloys.

(3) Grades for K Applications

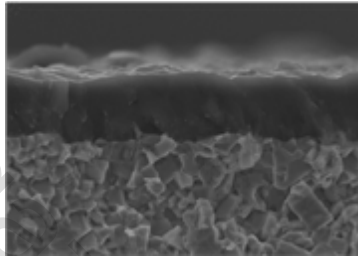
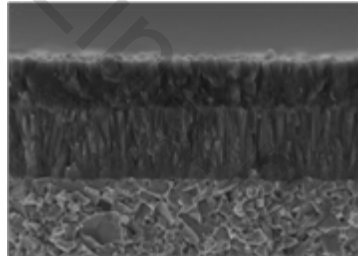
Grade	Application	Coating Structure	Advantages
GK4125	Semi-finishing and Roughing		The latest TiAlN coating combined with micro-fine-grained cemented carbide substrate has high adhesion strength, excellent wear resistance and toughness. Application: suitable for general-purpose medium to roughing milling of grey cast iron and nodular iron under dry and wet conditions.
GK2115	Semi-finishing		The latest medium-thick MT-TiCN+Al ₂ O ₃ coating combined with fine grained cemented carbide substrate has superior toughness and great wear resistance to ensure the processing stability and high effectiveness. Application: Suitable for finishing to semi-finishing milling for cast iron under medium to high speed conditions.

Milling Insert Grades

(4) Grades For N Applications

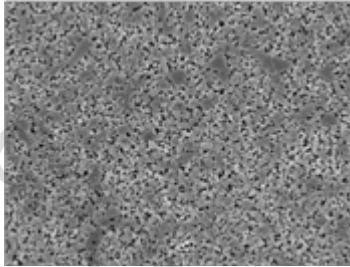
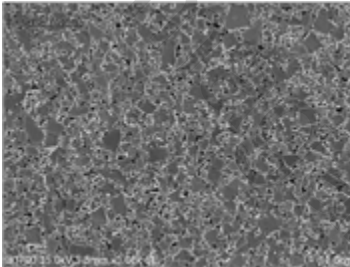
Grade	Application	Coating Structure	Advantages
GA0115	Semi-finishing		ncoated cemented carbides grade has excellent wear resistance. Application: Suitable for semi-finishing milling for aluminum alloys and part of some steels.
GN9125	Semi-finishing and Roughing		Uncoated fine-grained cemented carbide grade has great wear resistance and toughness. Application: Suitable for semi-finishing to roughing of copper, aluminum and other nonferrous metals.

(5) Grades For S Applications

Grade	Application	Coating Structure	Advantages
GS4130	Semi-finishing and Roughing		The latest TiAlN coating combined with micro-grained cemented carbide substrate with high toughness has excellent wear resistance and toughness. Application: Suitable for semi-finishing to roughing milling of titanium alloys and high-temperature heat resistant alloys.



Milling Insert Grades Introduction and Application

Workpiece	ISO	Coating		Uncoating	Cermet
		CVD	PVD		
P Steel	P01				GP01TM
	P10	GP2115			
	P20		GA4225, GP4225, GA4230		
	P30				
	P40				
	P50				
M Stainless Steel	M01				
	M10	GM2125			
	M20		GA4225, GA4230, GS4130		
	M30	GM2140			
	M40				
	M50				
K Cast Iron	K01				GP01TM
	K10	GK2125			
	K20		GK4125		
	K30				
	K40				
N Nonferrous Metal	N01				
	N10			GA0115	
	N20				GN9125
	N30				
	N40				
S HRSA	S01	GM2125			
	S10		GA4230		
	S20	GM2140		GN9125	
	S30		GS4130		
	S40				
H Hardened Material	H01				
	H10		GA4230		
	H20				
	H30				

Pitch Type

Choosing proper cutting tool teeth number is extremely important for balancing efficiency and precision in milling application. Under the same cutting speed V_c & feed per teeth f_z , increase the number of cutting edges can effectively increase producing efficiency, even though also increase the cutting force at the same time. Machine Power is an influence factor for cutting tool teeth number choosing. GESAC provides three type pitch for different application.

MFB145-080





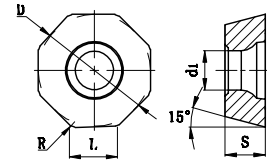

Shape			
	Coarse pitch	Close pitch	Extra Close pitch
NO. of Teeth	$Z_c=5$	$Z_c=7$	$Z_c=8$
Application	<p>The coarse-pitch cutter has superior rigidity, suitable for unstable working condition.</p> <p>Mainly used in high feeding, large cutting depth (ap). Big size chip.</p> <p>First priority for carbon steel and stainless steel machining</p>	<p>The close-pitch cutter has the best balance of rigidity and efficiency, most suitable for general purpose cutting of various material.</p> <p>Most suitable for medium feeding and medium cutting depth (ap).</p> <p>Medium size chip.</p> <p>Also suitable for hardened steel and heat-resistance alloy.</p>	<p>The close-pitch cutter has the best balance of rigidity and efficiency, most suitable for general purpose cutting of various material.</p> <p>Most suitable for medium feeding and medium cutting depth (ap).</p> <p>Medium size chip.</p> <p>Also suitable for hardened steel and heat-resistance alloy.</p>

Face Milling

OD*T











General Face Milling Inserts



Ordering Code	Dimensions (mm)					Coated								Unc- oat- ed	Cer- met
	L	D	S	d ₁	R	GA4225	GA4230	GP4225	GP2115	GM2140	GK4125	GK2115	GS4130	GN9125	GP01TM
 ODKT060508-GL	6.5	15.875	5.56	5.56	0.8	○	●	○	○	○	○	○	○		
 ODKT060508-GM	6.5	15.875	5.56	5.56	0.8	○	●	○	○	○	●	●	○		
 ODMT060508-GM	6.5	15.875	5.56	5.56	0.8	○	○	○	○	○	○	○	○		
 ODKT060508-GH	6.5	15.875	5.56	5.56	0.8	○	○	○	○						
 ODMT060508-GH	6.5	15.875	5.56	5.56	0.8	○	○	○	○						
 ODKT060508-AL	6.5	15.875	5.56	5.56	0.8									●	
 ODKW060508-WB	6.5	15.875	5.56	5.56	0.8	○	○	○	○		○	○			

● Stock ○ Available upon Order

OD*T Series Geometry

Light Cutting for General material I	Medium Cutting for G G eneral material	Heavy Cutting for General material	General cutting for aluminum alloys	Wipper
				
GL	GM	GH	AL	WB
				
Large rake angle with narrow edge width. Suitable for Light milling of low cutting speed and low feed	Large rake angle smoothly cutting. High stability milling can be achieved under general cutting conditions.	Wide chip pocket with strong cutting edge for Rough cutting.	Large rake angle, sharp cutting edge and good chip control.	Wiper design to improve the surface quality.

Face Milling

MFA143

Arbor

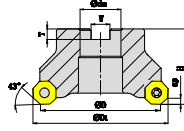

Fig1

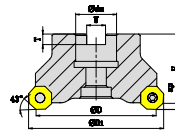

Fig2

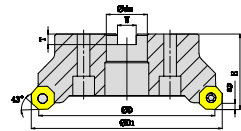

Fig3

Ordering Code	Diameters	Teeth	Dimensions (mm)						ap max	Gauge Insert	Coolant	Shape	Stock
			ΦD	ΦD ₁	Φd _m	H	W	T					
MFA143040R03A16OD06	40	3	40	50	16	40	8.4	5.6	4	OD**0605	X	Fig1	●
MFA143050R04A22OD06	50	4	50	60	22	40	10.4	6.3	4	OD**0605	X	Fig1	●
MFA143063R05A22OD06	63	5	63	72	22	40	10.4	6.3	4	OD**0605	X	Fig1	●
MFA143080R06B27OD06	80	6	80	90	27	50	12.4	7	4	OD**0605	X	Fig2	●
MFA143100R07B32OD06	100	7	100	110	32	50	14.4	8	4	OD**0605	X	Fig2	●
MFA143125R08B40OD06	125	8	125	135	40	63	16.4	9	4	OD**0605	X	Fig2	●
MFA143160R10C40OD06	160	10	160	170	40	63	16.4	9	4	OD**0605	X	Fig3	●
MFA143200R12C60OD06	200	12	200	210	60	63	25.7	14	4	OD**0605	X	Fig3	●

● Stock ○ Available upon Order

Spare Parts

Parts		Insert Screw	Insert Spanner
Insert	Shape		
	OD**0605	SI60M5X12-07013 730100961200	TT20P 720300960515

Recommended Cutting Data









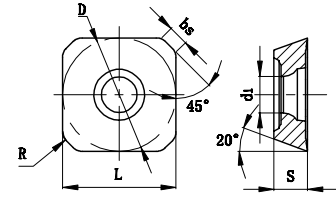

Workpiece Material	Material Hardness	Grade	Cutting peed Vc (m/min)	mm/toot (fz)			
				Light Cutting (L)	Medium Cutting (M)	Heavy Cutting (H)	
P	Mild Steel	≤HB200	GA4225 GP4225 GA4230	220 (180-300)	0.2 (0.1-0.3)	0.25 (0.1-0.4)	0.3 (0.2-0.5)
	Carbon Steel Alloy Steel	≤HRC35	GA4225 GA4230 GP2115 GS4130	200 (150-280)	0.2 (0.1-0.3)	0.25 (0.1-0.4)	0.3 (0.2-0.5)
	Carbon Steel Alloy Steel	HRC35-45	GA4230	150 (120-250)	0.2 (0.1-0.3)	0.25 (0.1-0.4)	0.3 (0.2-0.5)
M	Stainless Steel (Ferrite , Martensite)	≤HRC35	GM2140 GA4230 GS4130	160 (100-250)	0.15 (0.1-0.3)	0.2 (0.1-0.3)	0.25 (0.2-0.4)
K	Cast Iron Nodular Cast Iron	≤HB350	GK2115 GK4125	180 (120-250)	0.2 (0.1-0.3)	0.25 (0.1-0.4)	0.3 (0.2-0.5)
N	Nonferrous Metal	≤HB260	GN9125	≥300	0.15 (0.1-0.2)	0.2 (0.1-0.3)	0.25 (0.2-0.6)
S	Heat-resistant Alloy and Titanium Alloy	≤HRC35	GM2140 GA4230 GS4130	40 (30-60)	0.15 (0.1-0.2)	0.2 (0.1-0.3)	-

Face Milling

SE*T















General Face Milling Inserts



Ordering Code	Dimensions (mm)						Coated								Unc- oat- ed	Cerm et
	L	D	S	d ₁	R	bs	GA4225	GA4230	GP4225	GP2115	GM2140	GK4125	GK2115	GS4130		
 SEET1204AFEN-PL	12.7	12.7	4.76	5.5	1.2	2.5	●	○	○							○
 SEET13T3AGEN-PL	13.4	13.4	3.97	4.4	1	1.7	●	●	○	○	○			○		
 SEET13T3AGEN-PM	13.4	13.4	3.97	4.4	1.5	1.2	●	●	○	○	○			○		○
 SEMT13T3AGEN-PM	13.4	13.4	3.97	4.4	1.5	1.2	○	○	○	○	○			○		
 SEET13T3AGSN-PH	13.4	13.4	3.97	4.4	1.5	1.3	○	○	○	○						
 SEMT13T3AGSN-PH	13.4	13.4	3.97	4.4	1.5	1.3	○	○	○	○						
 SEET13T3AGSN-KM	13.4	13.4	3.97	4.4	1.5	1.3	○	○	○			○	○			
 SEET13T3AGSN-KH	13.4	13.4	3.97	4.4	1.6	1.3	○	○	○			○	○			
 SEET13T3AGFN-AL	13.4	13.4	3.97	4.4	0.4	2.2										○
 SEET13T3AGEN-WB	13.4	13.4	4.76	3.97	1.5	2.37	○	●	○							

● Stock ○ Available upon Order

SE*T13T3 Series Geometry

Light Cutting for General material	Medium Cutting for General material	Heavy Cutting for General material	Medium Cutting for Cast Iron	Rough Cutting for Cast Iron	General cutting for aluminum alloys	Wiper
						
PL	PM	PH	KM	KH	AL	WB
						
Large rake angle with Narrow edgewidth. Suit forlight milling of low cutting speed and low feed.	Smoothly cutting. High stability milling can be achieved under general cuttingconditions.	Strong cutting edge for intermittent cutting condition.	The chipbreaker specially applicable for cast iron under general cutting conditions. Most medium milling can be achieved.	Special chipbreaker for cast iron cutting and heavy cutting. Suitable for rough cutting.	Large rake angle, sharpcutting edge withsmoothly cutting	Wiper edge with big circle shape to improve the quality of finish surface.

Face Milling

MFA145

Arbor

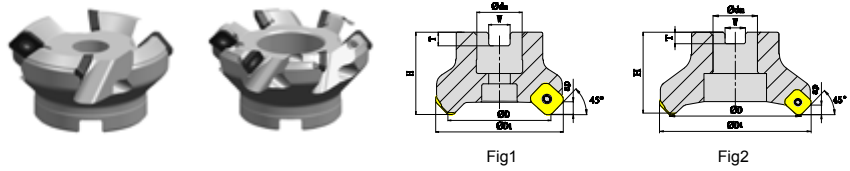

Coarse Pith

Ordering Code	Diame- ters	Teeth	Dimensions (mm)						apmax	Gauge Insert	Shim	Shape	Stock
			ΦD	ΦD ₁	Φdm	H	W	T					
MFA145050R03A22SE13	50	3	50	63	22	40	10.4	6.3	6	SE*T13T3	X	Fig1	○
MFA145063R04A22SE13	63	4	63	76	22	40	10.4	6.3	6	SE*T13T3	X	Fig1	○

● Stock ○ Available upon Order

Close Pith

Ordering Code	Diame- ters	Teeth	Dimensions (mm)						apmax	Gauge Insert	Shim	Shape	Stock
			ΦD	ΦD ₁	Φdm	H	W	T					
MFA145050R04A22SE13	50	4	50	63	22	40	10.4	6.3	6	SE*T13T3	X	Fig1	●
MFA145063R05A22SE13	63	5	63	76	22	40	10.4	6.3	6	SE*T13T3	X	Fig1	●
MFA145080R06B27SE13	80	6	80	93	27	50	12.4	7	6	SE*T13T3	√	Fig2	●
MFA145100R07B32SE13	100	7	100	113	32	50	14.4	8.3	6	SE*T13T3	√	Fig2	●
MFA145125R08B40SE13	125	8	125	138	40	50	16.4	8.3	6	SE*T13T3	√	Fig2	●

● Stock ○ Available upon Order

Face Milling

MFA145

Shank

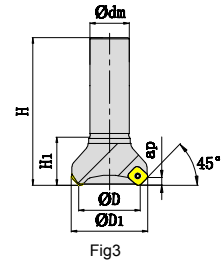

Coarse Pith

Ordering Code	Diame- ters	Teeth	Dimensions (mm)					apmax	Gauge Insert	Shim	Shape	Stock
			ΦD	ΦD ₁	Φdm	H	H ₁					
MFA145050R03P32SE13	50	3	50	63	32	120	39	6	SE*T13T3	X	Fig3	○
MFA145063R04P32SE13	63	4	63	76	32	120	39	6	SE*T13T3	X	Fig3	○

●Stock ○Available upon Order

Close Pith

Ordering Code	Diame- ters	Teeth	Dimensions (mm)					apmax	Gauge Insert	Shim	Shape	Stock
			ΦD	ΦD ₁	Φdm	H	H ₁					
MFA145050R04P32SE13	50	4	50	63	32	120	39	6	SE*T13T3	X	Fig3	○
MFA145063R05P32SE13	63	5	63	76	32	120	39	6	SE*T13T3	X	Fig3	○

●Stock ○Available upon Order

Spare Parts

Parts	Shim	Shim Screw	L Type Wrench	Insert Screw	Insert Spanner
Shape Insert					
SE*T13T3	X	X	TH35L	SI60M3.5X8.0-05410I	TT15P
	X	X	720301260019	730100961115	720300960510
SE*T13T3	DSE1300S	SSAM5X8.5F	TH35L	SI60M3.5X11.6-05410I	TT15P
	H0K40DSE1300S	730100910042	720301260019	730100961110	720300960510

Recommended Cutting Data





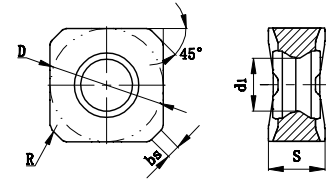

Workpiece Material	Material Hardness	Grade	Cutting Speed	mm/tooth (fz)			
			Vc (m/min)	Medium Cutting (L)	Medium Cutting (M)	Heavy Cutting (H)	
P	Low Carbon Steel	≤HB200	GA4225 GP4225 GA4230	250 (210-350)	0.15 (0.1-0.2)	0.2 (0.1-0.3)	0.3 (0.2-0.4)
	Carbon Steel Alloy Steel	≤HRC35	GA4225 GA4230 GP2115 GS4130	220 (170-270)	0.15 (0.1-0.2)	0.2 (0.1-0.3)	0.3 (0.2-0.4)
	Carbon Steel Alloy Steel	HRC35-45	GA4230	140 (100-180)	0.15 (0.1-0.2)	0.2 (0.1-0.3)	0.3 (0.2-0.4)
M	Stainless Steel (Ferrite, Martensite)	≤HRC35	GM2140 GA4230 GS4130	180 (130-250)	0.15 (0.1-0.2)	0.2 (0.1-0.3)	0.3 (0.2-0.4)
K	Gray Cast Iron Nodular Cast Iron	≤HB350	GK2115 GK4125	180 (130-250)	0.15 (0.1-0.2)	0.2 (0.1-0.3)	0.3 (0.2-0.4)
N	Aluminum	≤HB260	GN9125	≥300	0.15 (0.1-0.2)	0.2 (0.1-0.3)	0.3 (0.2-0.4)
S	Heat-resistant Alloy	≤HRC35	GM2140 GA4230 GS4130	40 (20-50)	0.15 (0.1-0.2)	0.2 (0.1-0.3)	--

Face Milling

SN*U











General Face Milling Inserts



Ordering Code	Dimensions (mm)							Coated							Uncoated	Cermet
	L	D	S	d ₁	R	bs	GA4225	GA4230	GP4225	GP2115	GM2140	GK4125	GK2115	GS4130	GN9125	GP01TM
 SNEU1206ANEN-GL	12.7	12.7	6.35	6.0	0.8	2.2	●	●	○	○	○	●	●	○		
 SNEU1206ANEN-GM	12.7		6.35	6.0	0.8	2.2	●	●	○	●	○	●	●	○		
 SNMU1206ANEN-GM	12.7		6.35	6.0	0.8	2.2	○	○	○	○	○	○	○	○		
 SNEU1206ANSN-GH	12.7		6.35	6.0	0.8	2.2	●	●	○	○		●	●			
 SNMU1206ANSN-GH	12.7		6.35	6.0	0.8	2.2	○	○	○	○		○	○			
 SNEU1206ANFN-NL	12.7		6.35	6.0	0.8	2.2									●	
 SNEU1206ANEN-GW	12.7		6.35	6.0	0.8	5.6	●	●	○	○		●	●			

● Stock ○ Available upon Order

SN*U Series Geometry

Light Cutting for General material	Medium Cutting for General material	Heavy Cutting for General material	General cutting for aluminum alloys	Wiper
				
GL	GM	GH	NL	GW
				
Large rake angle with Narrow edgewidth. Suit for lightmilling of low cutting speed and low feed.	Smoothlycutting. High stability milling can be achieved under general cutting conditions	Strong cutting edge for intermittent cutting condition.	Large rake angle, sharp cutting edge with smoothly cutting .	Wiper edge with big circle shape to improve the quality of finish surface.

cncmagazine.ru

Face Milling

MFB145

Arbor(With Shims)

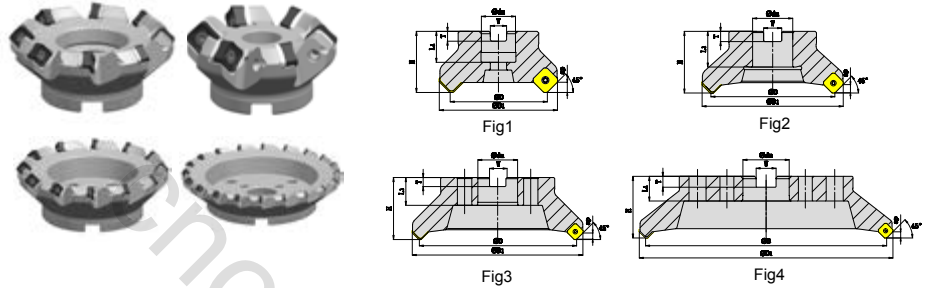

Coarse Pith

Ordering Code	Diameters	Teeth	Dimensions (mm)						apmax	Gauge Insert	Shim	Inner-cooling	Shape	Stock
			ΦD	ΦD ₁	Φdm	H	W	T						
MFB145050R03A22SN12	50	3	50	66	22	40	10.4	6.3	5	SN*U1206	√	√	Fig1	●
MFB145063R04A22SN12	63	4	63	79	22	40	10.4	6.3	5	SN*U1206	√	√	Fig1	●
MFB145080R05A27SN12	80	5	80	96	27	50	12.4	7.0	5	SN*U1206	√	√	Fig1	●
MFB145100R06B32SN12	100	6	100	116	32	50	14.4	8.0	5	SN*U1206	√	x	Fig2	●
MFB145125R07B40SN12	125	7	125	141	40	63	16.4	9.0	5	SN*U1206	√	x	Fig2	○
MFB145160R08C40SN12	160	8	160	176	40	63	16.4	9.0	5	SN*U1206	√	x	Fig3	○
MFB145200R10C60SN12	200	10	200	216	60	63	25.7	14	5	SN*U1206	√	x	Fig3	○
MFB145250R12C60SN12	250	12	250	266	60	63	25.7	14	5	SN*U1206	√	x	Fig3	○
MFB145315R15D60SN12	315	15	315	331	60	63	25.7	14	5	SN*U1206	√	x	Fig4	○

●Stock ○Available upon Order

Close Pith

Ordering Code	Diameters	Teeth	Dimensions (mm)						apmax	Gauge Insert	Shim	Inner-cooling	Shape	Stock
			ΦD	ΦD ₁	Φdm	H	W	T						
MFB145050R04A22SN12	50	4	50	66	22	40	10.4	6.3	5	SN*U1206	√	√	Fig1	●
MFB145063R05A22SN12	63	5	63	79	22	40	10.4	6.3	5	SN*U1206	√	√	Fig1	●
MFB145080R07A27SN12	80	7	80	96	27	50	12.4	7.0	5	SN*U1206	√	√	Fig1	●
MFB145100R08B32SN12	100	8	100	116	32	50	14.4	8.0	5	SN*U1206	√	x	Fig2	●
MFB145125R10B40SN12	125	10	125	141	40	63	16.4	9.0	5	SN*U1206	√	x	Fig2	●
MFB145160R12C40SN12	160	12	160	176	40	63	16.4	9.0	5	SN*U1206	√	x	Fig3	●
MFB145200R14C60SN12	200	14	200	216	60	63	25.7	14	5	SN*U1206	√	x	Fig3	●
MFB145250R16C60SN12	250	16	250	266	60	63	25.7	14	5	SN*U1206	√	x	Fig3	●
MFB145315R20D60SN12	315	20	315	331	60	63	25.7	14	5	SNE(M) U1206	√	x	Fig4	●

●Stock ○Available upon Order

Face Milling

MFB145

Arbor(With Shims)

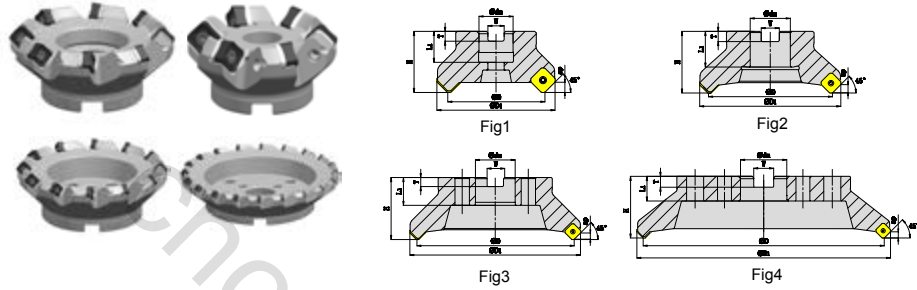

Extra Close Pith

Ordering Code	Diameters	Teeth	Dimensions (mm)						apmax	Gauge Insert	Shim	Inner-cooling	Shape	Stock
			ΦD	ΦD ₁	Φdm	H	W	T						
MFB145050R05A22SN12	50	5	50	66	22	40	10.4	6.3	5	SN*U1206	√	√	Fig1	●
MFB145063R06A22SN12	63	6	63	79	22	40	10.4	6.3	5	SN*U1206	√	√	Fig1	●
MFB145080R08A27SN12	80	8	80	96	27	50	12.4	7.0	5	SN*U1206	√	√	Fig1	●
MFB145100R10B32SN12	100	10	100	116	32	50	14.4	8.0	5	SN*U1206	√	x	Fig2	●
MFB145125R12B40SN12	125	12	125	141	40	63	16.4	9.0	5	SN*U1206	√	x	Fig2	○
MFB145160R15C40SN12	160	15	160	176	40	63	16.4	9.0	5	SN*U1206	√	x	Fig3	○
MFB145200R18C60SN12	200	18	200	216	60	63	25.7	14	5	SN*U1206	√	x	Fig3	○
MFB145250R21C60SN12	250	21	250	266	60	63	25.7	14	5	SN*U1206	√	x	Fig3	○
MFB145315R24D60SN12	315	24	315	331	60	63	25.7	14	5	SN*U1206	√	x	Fig4	○

●Stock ○Available upon Order

Spare Parts

Parts	Shim	Shim Screw	L Type Wrench	Insert Screw	Insert Spanner
Shape					
Insert					
SN*U1206	DSN1206M	SSAM6X7.5F	TH40L	SI60M4X15.8-07108	TT15P
	H0K40SSN12	730100910075	720301260456	730100961150	720300960510

Face Milling

MFB245

Arbor(No Shims)

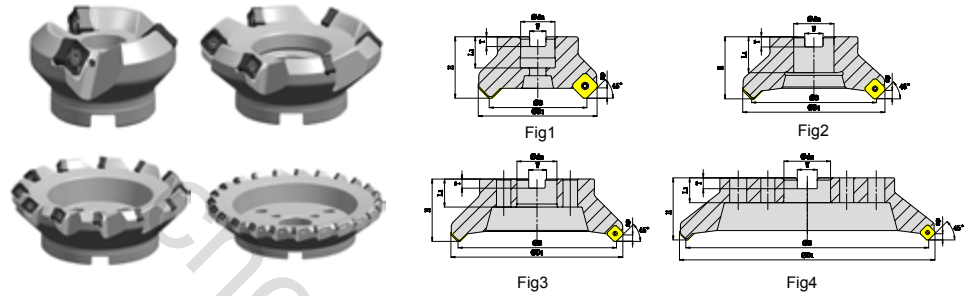

Coarse Pith

Ordering Code	Diameters	Teeth	Dimensions (mm)						apmax	Gauge Insert	Shim	Inner-cooling	Shape	Stock
			ΦD	ΦD ₁	Φdm	H	W	T						
MFB245050R03A22SN12	50	3	50	66	22	40	10.4	6.3	5	SN*U1206	x	√	Fig1	●
MFB245063R04A22SN12	63	4	63	79	22	40	10.4	6.3	5	SN*U1206	x	√	Fig1	●
MFB245080R05A27SN12	80	5	80	96	27	50	12.4	7.0	5	SN*U1206	x	√	Fig1	●
MFB245100R06B32SN12	100	6	100	116	32	50	14.4	8.0	5	SN*U1206	x	x	Fig2	●
MFB245125R07B40SN12	125	7	125	141	40	63	16.4	9.0	5	SN*U1206	x	x	Fig2	○
MFB245160R08C40SN12	160	8	160	176	40	63	16.4	9.0	5	SN*U1206	x	x	Fig3	○
MFB245200R10C60SN12	200	10	200	216	60	63	25.7	14	5	SN*U1206	x	x	Fig3	○
MFB245250R12C60SN12	250	12	250	266	60	63	25.7	14	5	SN*U1206	x	x	Fig3	○
MFB245315R15D60SN12	315	15	315	331	60	63	25.7	14	5	SN*U1206	x	x	Fig4	○

●Stock ○Available upon Order

Close Pith

Ordering Code	Diameters	Teeth	Dimensions (mm)						apmax	Gauge Insert	Shim	Inner-cooling	Shape	Stock
			ΦD	ΦD ₁	Φdm	H	W	T						
MFB245050R04A22SN12	50	4	50	66	22	40	10.4	6.3	5	SN*U1206	x	√	Fig1	●
MFB245063R05A22SN12	63	5	63	79	22	40	10.4	6.3	5	SN*U1206	x	√	Fig1	●
MFB245080R07A27SN12	80	7	80	96	27	50	12.4	7.0	5	SN*U1206	x	√	Fig1	●
MFB245100R08B32SN12	100	8	100	116	32	50	14.4	8.0	5	SN*U1206	x	x	Fig2	●
MFB245125R10B40SN12	125	10	125	141	40	63	16.4	9.0	5	SN*U1206	x	x	Fig2	●
MFB245160R12C40SN12	160	12	160	176	40	63	16.4	9.0	5	SN*U1206	x	x	Fig3	●
MFB245200R14C60SN12	200	14	200	216	60	63	25.7	14	5	SN*U1206	x	x	Fig3	●
MFB245250R16C60SN12	250	16	250	266	60	63	25.7	14	5	SN*U1206	x	x	Fig3	●
MFB245315R20D60SN12	315	20	315	331	60	63	25.7	14	5	SN*U1206	x	x	Fig4	●

●Stock ○Available upon Order

Face Milling

MFB245

Arbor(No Shims)

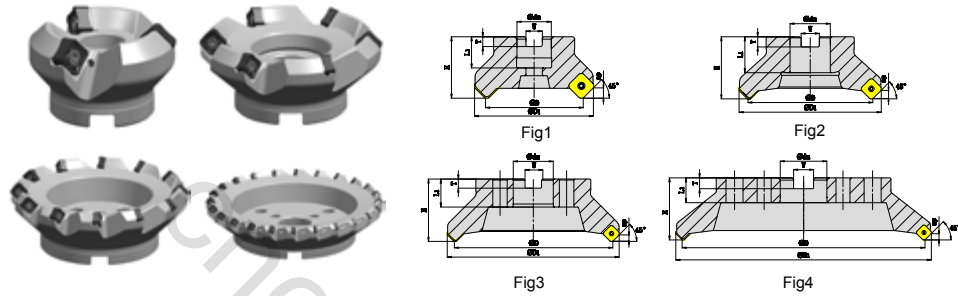

Extra Close Pith

Ordering Code	Diameters	Teeth	Dimensions (mm)						apmax	Gauge Insert	Shim	Inner-cooling	Shape	Stock
			ΦD	ΦD ₁	Φdm	H	W	T						
MFB245050R05A22SN12	50	5	50	66	22	40	10.4	6.3	5	SN*U1206	√	√	Fig1	●
MFB245063R06A22SN12	63	6	63	79	22	40	10.4	6.3	5	SN*U1206	√	√	Fig1	●
MFB245080R08A27SN12	80	8	80	96	27	50	12.4	7.0	5	SN*U1206	√	√	Fig1	●
MFB245100R10B32SN12	100	10	100	116	32	50	14.4	8.0	5	SN*U1206	√	x	Fig2	●
MFB245125R12B40SN12	125	12	125	141	40	63	16.4	9.0	5	SN*U1206	√	x	Fig2	○
MFB245160R15C40SN12	160	15	160	176	40	63	16.4	9.0	5	SN*U1206	√	x	Fig3	○
MFB245200R18C60SN12	200	18	200	216	60	63	25.7	14	5	SN*U1206	√	x	Fig3	○
MFB245250R21C60SN12	250	21	250	266	60	63	25.7	14	5	SN*U1206	√	x	Fig3	○
MFB245315R24D60SN12	315	24	315	331	60	63	25.7	14	5	SN*U1206	√	x	Fig4	○

●Stock ○Available upon Order

Spare Parts

Parts	Insert Screw	Insert Spanner
Insert Shape		
SN*U1206	SI60M5X14-07010 730100961212	TT20P 720300960515

Recommended Cutting Data





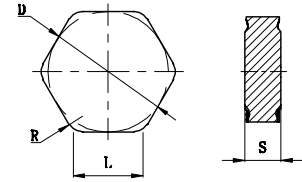

Workpiece Material	Material Hardness	Grade	Cutting Speed	mm/tooth (fz)			
			Vc (m/min)	Medium Cutting (L)	Medium Cutting (M)	Heavy Cutting (H)	
P	Low Carbon Steel	≤HB200	GA4225 GP4225 GA4230	250 (200-300)	0.15 (0.1-0.2)	0.2 (0.1-0.3)	0.3 (0.2-0.4)
	Carbon Steel Alloy Steel	≤HRC35	GA4225 GA4230 GP2115 GS4130	220 (170-270)	0.15 (0.1-0.2)	0.2 (0.1-0.3)	0.3 (0.2-0.4)
	Carbon Steel Alloy Steel	HRC35-45	GA4230	150 (100-200)	0.12 (0.1-0.15)	0.15 (0.1-0.2)	0.2 (0.15-0.25)
M	Stainless Steel (Ferrite, Martensite)	≤HRC35	GM2140 GA4230 GS4130	180 (130-250)	0.15 (0.1-0.2)	0.2 (0.1-0.3)	-
K	Gray Cast Iron Nodular Cast Iron	≤HB350	GK2115 GK4125	180 (130-250)	0.15 (0.1-0.2)	0.2 (0.1-0.3)	0.3 (0.2-0.4)
N	Aluminum	≤HB260	GN9125	800 (300-1000)	0.15 (0.1-0.2)	0.2 (0.1-0.3)	-
S	Heat-resistant Alloy	≤HRC35	GM2140 GA4230 GS4130	40 (20-50)	0.05 (0.05-0.1)	0.1 (0.05-0.15)	-

Face Milling

HN*X









General Face Milling Inserts



Ordering Code	Dimensions (mm)					Coated								Uncoated	Cermet
	L	D	S	d ₁	R	GA4225	GA4230	GP4225	GP2115	GM2140	GK4125	GK2115	GS4130	GN9125	GP01TM
	HNEX090520-KF	9.5	16.2	5.56	-	2.0					●	●			
	HNEX090510-KF	9.5	16.2	5.56	-	1.0					●	●			
	HNEX090520-KM	9.5	16.2	5.56	-	2.0					●	●			
	HNMX090520-KM	9.5	16.2	5.56	-	2.0					○	○			
	HNEX090516-KR	9.5	16.2	5.56	-	1.6					●	●			
	HNMX090516-KR	9.5	16.2	5.56	-	1.6					○	○			
	HNEX090530-KR	9.5	16.2	5.56	-	3.0					●	●			
	HNEX090502-WC	9.5	15.875	5.56	-	0.2					●	●			

●Stock ○Available upon Order

HN*X Series Geometry

Light Cutting for CastIron	Medium Cutting for CastIron	Rough Cutting for CastIron	Wiper
			
KF	KM	KR	WC
			
Light cutting chipbreaker Large rake angle through a small ridge width and smaller width slot design	Medium cutting chipbreaker Sector shape antilitter surface designing with unique edge width ratio	heavy cutting chipbreaker Large flank width design with a unique rake face designing	Wiper insert Obtained high surface quality and stability with Cartridge.

Face Milling

MFB160

Arbor(Adjustable)

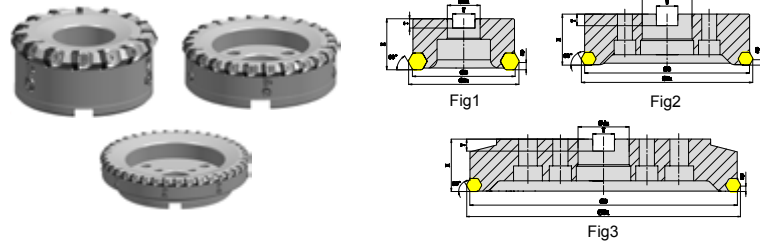

Close pitch

Ordering Code	Diam-eters	Teeth	Dimensions (mm)						apmax	Gauge Insert	Shim	Inner-cooling	Shape	Stock
			ΦD	ΦD ₁	Φdm	H	W	T						
MFB160125R15B40HN09	125	15	125	135	40	63	16.4	9	8	HN*X0905	X	√	Fig1	●
MFB160160R20C40HN09	160	20	160	170	40	63	16.4	9	8	HN*X0905	X	√	Fig2	●
MFB160200R25C60HN09	200	25	200	210	60	63	25.7	14	8	HN*X0905	X	√	Fig2	●
MFB160250R30C60HN09	250	30	250	260	60	80	25.7	14	8	HN*X0905	X	√	Fig2	○
MFB160315R40D60HN09	315	40	315	325	60	80	25.7	14	8	HN*X0905	X	√	Fig3	○

●Stock ○Available upon Order

Spare Parts

Parts	Axial Adjustment wedge	clamp wedge	Screw	Screw	Cartridge	Wrench	Wrench
Shape							
Insert	CWA1	CWA2	SDAM6X20	SDAM8X24.5	-	TH30L	TH40L
HN*X0905	731309009055	731309009056	730100460059	730100460067	731300363291	720301260455	720301260456

Face Milling

MFB260

Arbor(Unadjustable)

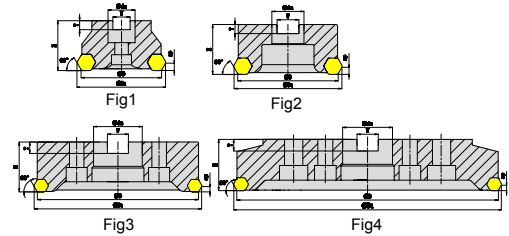
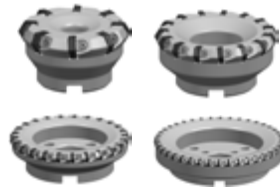

Close pitch

Ordering Code	Diam-eters	Teeth	Dimensions (mm)						apmax	Gauge Insert	Shim	Inner-cooling	Shape	Stock
			ΦD	ΦD ₁	Φdm	H	W	T						
MFB260080R08A27HN09	80	8	80	90	27	50	1.24	7	8	HN*X0905	X	X	Fig1	●
MFB260100R10B32HN09	100	10	100	110	32	50	14.4	8	8	HN*X0905	X	X	Fig2	●
MFB260125R15B40HN09	125	15	125	135	40	63	16.4	9	8	HN*X0905	X	X	Fig2	●
MFB260160R20C40HN09	160	20	160	170	40	63	16.4	9	8	HN*X0905	X	X	Fig3	○
MFB260200R25C60HN09	200	25	200	210	60	63	25.7	14	8	HN*X0905	X	X	Fig3	○
MFB260250R30C60HN09	250	30	250	260	60	80	25.7	14	8	HN*X0905	X	X	Fig3	○
MFB260315R40D60HN09	315	40	315	325	60	80	25.7	14	8	HN*X0905	X	X	Fig4	○

●Stock ○Available upon Order

Spare Parts

Parts	clamp wedge	Screw	Wrench
Shape			
Insert			
HN*X0905	CWA1	SDAM6X20	TH30L
	731309009055	730100460059	720301260455

Recommended Cutting Data

Workpiece Material	Material Hardness	Grade	Cutting Speed	mm/tooth (fz)		
			Vc (m/min)	Medium Cutting (L)	Medium Cutting (M)	Heavy Cutting (H)
Cast Iron Nodular Cast Iron	≤HB350	GK4125 GK2115	280 (180-400)	0.15 (0.1-0.2)	0.2 (0.1-0.3)	0.3 (0.2-0.4)

Face Milling

SBEX

ISO Face Milling Inserts

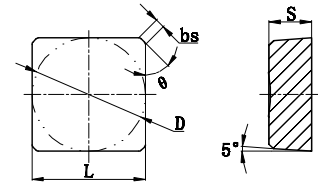



Ordering Code	Dimensions (mm)					Coated							Uncoated	Cermet	
	L	D	S	θ	bs	GA4225	GA4230	GP4225	GP2115	GM2140	GK4125	GK2115	GS4130	GN9125	GP01TM
 SBEX1204ZZ-1	12.7	12.7	4.76	45°	0.8		○				○				

● Stock ○ Available upon Order

SEEN/SEMN/SEEX

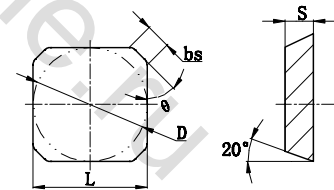
ISO Face Milling Inserts



Ordering Code	Dimensions (mm)					Coated							Uncoated	Cermet	
	L	D	S	θ	bs	GA4225	GA4230	GP4225	GP2115	GM2140	GK4125	GK2115	GS4130	GN9125	GP01TM
 SEEN1203AFTN	12.7	12.7	3.18	45°	2.3		○				○				
	SEEN1204AFTN	12.7	12.7	4.76	45°	2.4		○			○				
	SEEN1504AFTN	15.875	15.875	4.76	45°	2.4		○			○				
	SEMN1204AFTN	12.7	12.7	4.76	45°	2.4		○			○				
 SEEX1203AFTN	12.7	12.7	3.18	45°	3.0		○				○	○			

● Stock ○ Available upon Order

Face Milling

SEEN-R

ISO Face Milling Inserts

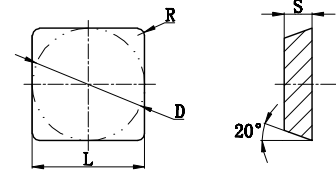



Ordering Code	Dimensions (mm)				Coated								Uncoated	Cermet	
	L	D	S	R	GA4225	GA4230	GP4225	GP2115	GM2140	GK4125	GK2115	GS4130	GN9125	GP01TM	
	SEEN120302	12.7	12.7	3.18	0.2		○								
	SEEN120308	12.7	12.7	3.18	0.8		○								

●Stock ○Available upon Order

SPEN

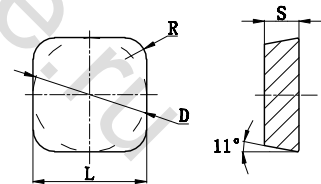
ISO Face Milling Inserts



Ordering Code	Dimensions(mm)				Coated								Uncoated	Cermet	
	L	D	S	R	GA4225	GA4230	GP4225	GP2115	GM2140	GK4125	GK2115	GS4130	GN9125	GP01TM	
	SPEN150420T	15.875	15.875	4.76	2.0		○				○				
	SPEN150430T	15.875	15.875	4.76	3.0		○				○				
	SPEN190424T	19.05	19.05	4.76	2.4		○				○				
	SPEN250730T	25.4	25.4	7.94	3.0		○				○				
	SPEN250750T	25.4	25.4	7.94	5.0		○				○				
	SPEN250730-WC	25.4	25.4	7.94	3.0						○				

●Stock ○Available upon Order

Face Milling

SPKN

ISO Face Milling Inserts

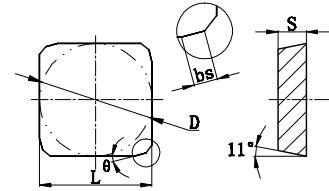

Ordering Code	Dimensions (mm)					Coated							Uncoated	Cermet	
	L	D	S	θ	bs	GA4225	GA4230	GP4225	GP2115	GM2140	GK4125	GK2115	GS4130	GN9125	GP01TM
SPKN1203EDL	12.7	12.7	3.18	15°	1.4		○				○				
SPKN1203EDR	12.7	12.7	3.18	15°	1.4		○				○				
SPKN1203EDTL	12.7	12.7	3.18	15°	1.4		○				○				
SPKN1203EDTR	12.7	12.7	3.18	15°	1.4		○				○	○			
SPKN1504EDL	15.875	15.875	4.76	15°	1.4		○				○				
SPKN1504EDR	15.875	15.875	4.76	15°	1.4		○				○	○			
SPKN1504EDTL	15.875	15.875	4.76	15°	1.4		○				○				
SPKN1504EDTR	15.875	15.875	4.76	15°	1.4		○				○	○			
SPKN1905EDL	19.05	19.05	5.56	15°	2.7		○				○				
SPKN1905EDR	19.05	19.05	5.56	15°	2.7		○				○				
SPKN1905EDTL	19.05	19.05	5.56	15°	2.7		○				○				
SPKN1905EDTR	19.05	19.05	5.56	15°	2.7		○				○				



●Stock ○Available upon Order

SPEN-W

ISO Face Milling Inserts

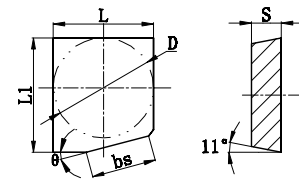

Ordering Code	Dimensions (mm)					Coated							Uncoated	Cermet	
	L	D	S	θ	bs	GA4225	GA4230	GP4225	GP2115	GM2140	GK4125	GK2115	GS4130	GN9125	GP01TM
SPEN1504EDL-W	15.875	15.875	4.76	15°	10.2		○				○				
SPEN1504EDR-W	15.875	15.875	4.76	15°	10.2		○				○				





●Stock ○Available upon Order

Face Milling

SPER

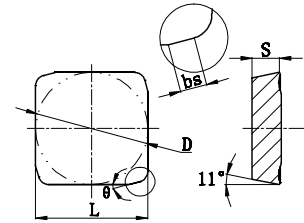
ISO Face Milling Inserts





Ordering Code	Dimensions (mm)					Coated							Uncoated	Cermet		
	L	D	S	θ	bs	GA4225	GA4230	GP4225	GP2115	GM2140	GK4125	GK2115	GS4130	GN9125	GP01TM	
	SPER1203EDTL-MR	12.7	12.7	3.18	15°	1.3		○								
	SPER1203EDTR-MR	12.7	12.7	3.18	15°	1.3		○				○				

●Stock ○Available upon Order

SPNR

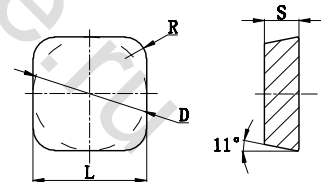
ISO Face Milling Inserts



Ordering Code	Dimensions (mm)				Coated							Uncoated	Cermet			
	L	D	S	R	GA4225	GA4230	GP4225	GP2115	GM2140	GK4125	GK2115	GS4130	GN9125	GP01TM		
	SPNR150424T	12.7	12.7	4.76	2.4		○									

●Stock ○Available upon Order

Face Milling

SPCW

ISO Face Milling Inserts

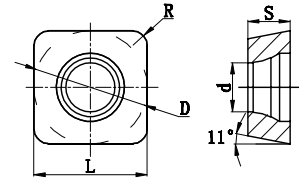



Ordering Code	Dimensions (mm)					Coated							Uncoated	Cermet		
	L	D	S	d	R	GA4225	GA4230	GP4225	GP2115	GM2140	GK4125	GK2115	GS4130	GN9125	GP01TM	
	SPCW090308	9.525	9.525	3.18	4.4	0.8		○				○	○			
	SPCW120412	12.7	12.7	4.76	5.5	1.2		○				○				
	SPCW120416	12.7	12.7	4.76	5.5	1.6		○				○				
	SPCW150516	15.875	15.875	5.56	5.5	1.6		○				○				

● Stock ○ Available upon Order

SPKT

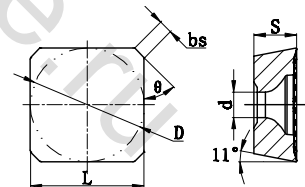
ISO Face Milling Inserts



Ordering Code	Dimensions (mm)					Coated							Uncoated	Cermet		
	L	D	S	θ	bs	GA4225	GA4230	GP4225	GP2115	GM2140	GK4125	GK2115	GS4130	GN9125	GP01TM	
	SPKT1204AZSN-SM	12.7	12.7	4.76	45°	1.5		○				○				



● Stock ○ Available upon Order

Face Milling

TPER/TPKR/TPKN

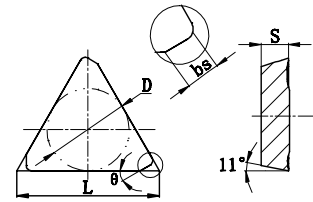
ISO Face Milling Inserts



Ordering Code	Dimensions (mm)					Coated								Uncoated	Cermet
	L	D	S	θ	bs	GA4225	GA4230	GP4225	GP2115	GM2140	GK4125	GK2115	GS4130	GN9125	GP01TM
	TPER1603PDTL-MR	16.5	9.525	3.18	30°	1.3	○				○				
	TPER1603PDTR-MR	16.5	9.525	3.18	30°	1.3	○				○				
	TPKR1603PPTR	16.5	9.525	3.18	30°	1.3	○				○				
	TPKN1603PDL	16	16	3.18	30°	1.3	○				○				
	TPKN1603PDR	16	16	3.18	30°	1.3	○				○				
	TPKN1603PDTL	16	16	3.18	30°	1.3	○				○				
	TPKN1603PDTR	16	16	3.18	30°	1.3	○				○				
	TPKN2204PDL	22	22	4.76	30°	1.4	○				○				
	TPKN2204PDR	22	22	4.76	30°	1.4	○				○				
	TPKN2204PDTL	22	22	4.76	30°	1.4	○				○				
	TPKN2204PDTR	22	22	4.76	30°	1.4	○				○				

●Stock ○Available upon Order

Face Milling

TPNR

ISO Face Milling Inserts

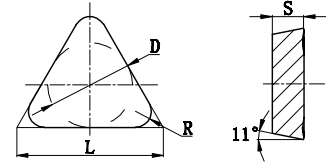

Ordering Code	Dimensions (mm)				Coated								Uncoated	Cermet
	L	D	S	R	GA4225	GA4230	GP4225	GP2115	GM2140	GK4125	GK2115	GS4130	GN9125	GP01TM
	TPNR220424T	22	12.7	4.76	2.4		○				○			

● Stock ○ Available upon Order





cncmagazine.ru

General Shoulder Milling

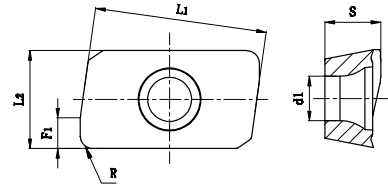
APMT/APGT









General Shoulder Milling Inserts



Ordering Code	Dimensions (mm)						Coated								Uncoated	Cermet
	L1	L2	S	F1	d1	R	GA4225	GA4230	GP4225	GP2115	GM2140	GK4125	GK2115	GS4130	GN9125	GP01TM
 APMT1135PDER-PL	10.83	6.16	3.5	1.92	2.8	0.8	●	●	●	○	○	○	○	○		
	16.26	9.26	4.76	2	4.6	0.8	●	●	●	○	○	○	○	○		
 APMT1135PDER-PM	10.83	6.16	3.5	1.92	2.8	0.8	●	●	●	○	○	●	●	○		
	16.26	9.26	4.76	2	4.6	0.8	●	●	●	○	○	●	●	○		
 APMT1135PDER-PR	10.83	6.16	3.5	1.87	2.8	0.8	●	●	●	○	○	●	○	○		
	16.26	9.26	4.76	2.2	4.6	0.8	●	●	●	○	○	●	●	○		
 APGT1135PDFR-AL	10.83	6.16	3.5	1.92	2.8	0.8									○	
	16.26	9.26	4.76	2.2	4.4	0.8									○	

● Stock ○ Available upon Order

APMT/APGT Series Geometry

Light Cutting for General material	Medium Cutting for General material	Rough Cutting for General material	General cutting for aluminum alloys
			
PL	PM	PR	AL
			
Light cutting with low force to achieve excellent performance	High stability cutting in general condition	More stronger edge for rough cutting	Shape edge with excellent polishing for aluminum material cutting

General Shoulder Milling

MEA190

Arbor

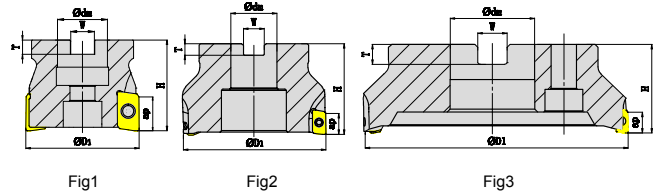

Ordering Code	Diameters	Teeth	Dimensions (mm)					A _{pmax}	Gauge Insert	Coolant	Shape	Stock
			ΦD ₁	Φd _m	H	W	T					
MEA190040R05A16AP11	40	5	40	16	40	8.4	5.6	09	AP*T1135	×	Fig1	○
MEA190050R06A22AP11	50	6	50	22	40	10.4	6.3	09	AP*T1135	×	Fig1	○
MEA190050R04A22AP16	50	4	50	22	40	10.4	6.3	14	AP*T1604	×	Fig1	●
MEA190063R05A22AP16	63	5	63	22	40	10.4	6.3	14	AP*T1604	×	Fig1	●
MEA190080R06A27AP16	80	6	80	27	50	12.4	7	14	AP*T1604	×	Fig1	●
MEA190100R07B32AP16	100	7	100	32	63	14.4	8	14	AP*T1604	×	Fig2	●
MEA190125R08B40AP16	125	8	125	40	63	16.4	9	14	AP*T1604	×	Fig2	○
MEA190160R10C40AP16	160	10	160	40	63	25.7	14	14	AP*T1604	×	Fig3	○
MEA190200R12C60AP16	200	12	200	60	63	25.7	14	14	AP*T1604	×	Fig3	○
MEA190250R14C60AP16	250	14	250	60	63	25.7	14	14	AP*T1604	×	Fig3	○

●Stock ○Available upon Order

General Shoulder Milling

MEA190

Shank

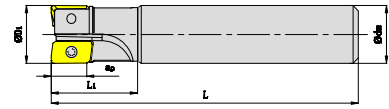

Fig4

Ordering Code	Diameters	Teeth	Dimensions (mm)				Apm _{ax}	Gauge Insert	Coolant	Shape	Stock
			ΦD ₁	Φd _m	L	L ₁					
MEA190016R02P16AP11	16	2	16	16	120	40	9	AP*T1135	×	Fig4	●
MEA190016R02P16AP11L	16	2	16	16	170	50	9	AP*T1135	×	Fig4	○
MEA190020R02P20AP11	20	2	20	20	160	50	9	AP*T1135	×	Fig4	●
MEA190020R03P20AP11	20	3	20	20	160	50	9	AP*T1135	×	Fig4	●
MEA190025R03P25AP11	25	3	25	25	160	50	9	AP*T1135	×	Fig4	●
MEA190025R04P25AP11	25	4	25	25	160	50	9	AP*T1135	×	Fig4	●
MEA190025R02P25AP16	25	2	25	25	160	50	14	AP*T1604	×	Fig4	●
MEA190032R04P32AP11	32	4	32	32	160	80	9	AP*T1135	×	Fig4	●
MEA190032R03P32AP16	32	3	32	32	160	80	14	AP*T1604	×	Fig4	●

●Stock ○Available upon Order

Spare Parts

Parts	Insert Screw	InsertSpanner
Shape Insert		
AP*T1135	SI60M2.5X6 730100961040	TT08P 720300960508
AP*T1604	SI60M4X10 730100961135	TT15P 720300960510

Recommended Cutting Data

Workpiece Material	Material Hardness	Grade	Cutting Speed	mm/tooth (fz)			
				Light Cutting(L)	Medium Cutting(M)	Heavy Cutting(H)	
				Vc (m/min)	PL/AL	PM/AL	PR/AL
P	Low Carbon Steel	≤HB180	GA4225 GA4230 GP4225	180 (150-220)	0.1 (0.05-0.15)	0.15 (0.1-0.2)	0.2 (0.1-0.25)
	Carbon Steel, Alloy Steel	HB180-350	GA4225 GA4230 GP4225	150 (120-200)	0.1 (0.05-0.15)	0.15 (0.1-0.2)	0.2 (0.1-0.25)
	Per-hardened Steel	HRC35-45	GA4225 GA4230 GP4225	150 (120-200)	0.1 (0.05-0.15)	0.15 (0.1-0.2)	0.2 (0.1-0.25)
M	Stainless Steel (Ferrite, Martensite)	≤HB270	GA4225 GA4230 GM2140	140 (100-160)	0.12 (0.1-0.2)	0.15 (0.1-0.2)	0.2 (0.1-0.3)
	Stainless Steel (Austenite, Diphasic)	≤HB270	GA4225 GA4230 GM2140	120 (100-160)	0.12 (0.1-0.2)	0.15 (0.1-0.2)	0.2 (0.1-0.3)
K	Grey Cast Iron	≤HB280	GA4230 GK4125 GK2115	180 (150-220)	0.1 (0.05-0.15)	0.15 (0.1-0.2)	0.2 (0.1-0.25)
	Nodular Cast Iron Vermicular Cast Iron	≤HB350	GA4230 GK4125 GK2115	120 (100-180)	0.1 (0.05-0.15)	0.15 (0.1-0.2)	0.2 (0.1-0.25)
N	Aluminum Alloy HB60-210	≤HB260	GN9125	500 (200-900)	0.1 (0.05-0.15)	0.15 (0.1-0.2)	0.15 (0.1-0.25)
S	Heat-resistant Alloy and Titanium Alloy	HRC25-35	GA4230 GM2140 GS4130	60 (50-100)	0.1 (0.05-0.15)	0.1 (0.05-0.15)	0.15 (0.1-0.2)
H	Quenching Steel	HRC48-55	GA4230	80 (60-120)	0.08 (0.05-0.15)	0.10 (0.08-0.15)	0.12 (0.08-0.20)

General Shoulder Milling

XPHT

General Shoulder Milling Inserts

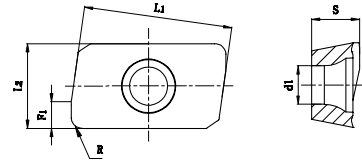

Ordering Code	Dimensions (mm)						Coated							Uncoated	Cermet	
	L ₁	L ₂	S	F ₁	d ₁	R	GA4225	GA4230	GP4225	GP2115	GM2140	GK4125	GK2115	GS4130	GN9125	GP01TM
 XPHT160408T	15.6	9.53	4.76	2	4.65	0.8					○					
XPHT160412T	15.6	9.53	4.76	2	4.65	1.2					○					

● Stock ○ Available upon Order

cncmagazine.ru

Profile Milling

RD

Profile Milling Inserts

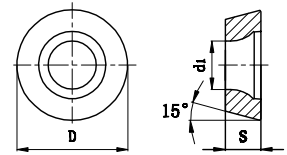

Ordering Code	Dimensions (mm)			Coated								Uncoated	Cerm-et
	D	S	d1	GA4225	GA4230	GP4225	GP2115	GM2140	GK4125	GK2115	GS4130	GN9125	GP01TM
	RDET0803M0-BL	8	3.18	2.94	○	○					○		
	RDET10T3M0-BL	10	3.97	4.4	●	○					○		
	RDET1204M0-BL	12	4.76	4.4	●	○					○		
	RDET1604M0-BL	16	4.76	5.5	●	○					○		
	RDET0802M0-GM	8	2.38	2.94	●	○	○				○		
	RDET0803M0-GM	8	3.18	2.94		○	○				○		
	RDET10T3M0-GM	10	3.97	4.4	●	●	○		○		○		
	RDET1204M0-GM	12	4.76	4.4	●	●	○		○		○		
	RDET1604M0-GM	16	4.76	5.5		●	○				○		
	RDET1204M0T-MM	12	4.76	4.4	●	○	○				○		
	RDEW0501M0	5	1.51	2.2	●	○	○						
	RDEW0702M0	7	2.38	2.8	●	○	○						
	RDEW1003M0	10	3.18	4.4		○	○						
	RDEW0702M0T	7	2.38	2.8		○	○						
	RDEW0803M0T	8	3.18	2.94	●	○	○						
	RDEW10T3M0T	10	3.97	4.4	●	●	○						
	RDEW1204M0T	12	4.76	4.4	●	●	○						
	RDEW1604M0T	16	4.76	5	●	●	○						
	RDEW12T3M0T-BM	12	3.97	4.4		○	○						
	RDEW1204M0T-BM	12	4.76	4.4		●	○						

●Stock ○Available upon Order

Profile Milling

RD



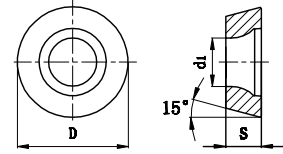





Profile Milling Inserts



Ordering Code		Dimensions (mm)			Coated								Uncoated	Cerm-et
		D	S	d1	GA4225	GA4230	GP4225	GP2115	GM2140	GK4125	GK2115	GS4130	GN9125	GP01TM
	RDMT10T3M0-GM	10	3.97	4.4	●	●	○	○	○	○	○	○		
	RDMT1204M0-GM	12	4.76	4.4	●	●	○	○	○	○	○	○		
	RDMW1204M0T-BM	12	4.76	4.4	●	●	○	●		○	○			
	RDMW1605M0T-BM	16	5.56	5.5	●	●	○	○		○	○			
	RDMW10T3M0T	10	3.97	4.4	●	●	○	○		○	○			
	RDMW1604M0T	16	4.76	5.5		●	○	○		○	○			

● Stock ○ Available upon Order

RD Series Geometry

LightCutting for General material	Medium Cutting for General material	Heavy cutting for General material	
			
BL	GM	None	
			
Design with big front rake angle makes the cutting edges sharper.	Design with medium rake angle and edge width. Combine sharp with strength	Design with flat chipbreaker makes the cutting edge stronger.	

Profile Milling

MPA100

Arbor

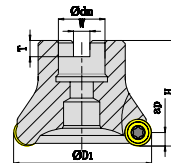

Fig1

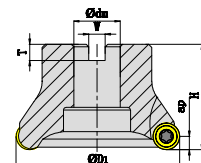

Fig2

Ordering Code	Diameters	Teeth	Dimensions (mm)					A _{pmax}	Gauge Insert	Coolant	Shape	Stock
			ϕD_1	ϕd_m	H	W	T					
MPA100040R05A16RD08	40	5	40	16	40	8.4	6.3	4	RD**0803	×	Fig1	●
MPA100050R04A22RD10	50	4	50	22	50	10.4	6.3	5	RD**10T3	×	Fig1	●
MPA100050R04A22RD12	50	4	50	22	50	10.4	6.3	6	RD**1204	×	Fig1	●
MPA100050R05A22RD12	50	5	50	22	50	10.4	6.3	6	RD**1204	×	Fig1	●
MPA100052R05A22RD12	52	5	52	22	50	10.4	6.3	6	RD**1204	×	Fig1	○
MPA100063R05A22RD12	63	5	63	22	50	10.4	6.3	6	RD**1204	×	Fig1	●
MPA100063R04A22RD16	63	4	63	22	40	10.4	6.3	8	RD**1604	×	Fig1	●
MPA100080R05A27RD16	80	5	80	27	50	12.4	7	8	RD**1604	×	Fig1	●
MPA100100R06B32RD16	100	6	100	32	50	14.4	9	8	RD**1604	×	Fig2	●
MPA100125R07B40RD16	125	8	125	40	63	16.4	9	8	RD**1604	×	Fig2	○

● Stock ○ Available upon Order

Profile Milling

MPA100

Shank

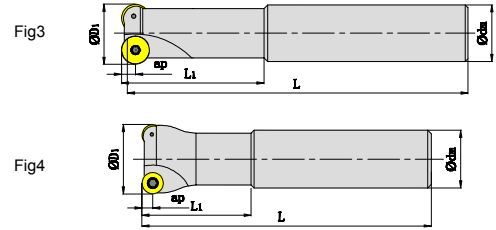

Ordering Code	Diameters	Teeth	Dimensions (mm)				Apmax	Gauge Insert	Coolant	Shape	Stock
			ΦD_1	Φd_m	L	L ₁					
MPA100010R02P16RD05	10	2	10	16	120	40	2.5	RD**0501	×	Fig3	○
MPA100012R02P16RD05	12	2	12	16	120	40	3.5	RD**0501	×	Fig3	○
MPA100016R02P16RD07	16	2	16	16	160	60	3.5	RD**0702	×	Fig3	●
MPA100017R02P16RD08	17	2	17	16	160	60	4	RD**0803	×	Fig4	●
MPA100020R02P20RD08	20	2	20	20	160	60	4	RD**0803	×	Fig3	○
MPA100020R02P20RD10	20	2	20	20	160	50	5	RD**10T3	×	Fig3	○
MPA100025R02P20RD10	25	2	25	20	160	50	5	RD**10T3	×	Fig4	●
MPA100032R02P25RD12	32	2	32	25	200	60	6	RD**1204	×	Fig4	●
MPA100032R02P32RD16	32	2	32	32	200	80	8	RD**1604	×	Fig3	●
MPA100035R02P32RD16	35	2	35	32	200	80	8	RD**1604	×	Fig4	●

●Stock ○Available upon Order

Profile Milling

RP

Profile Milling Inserts

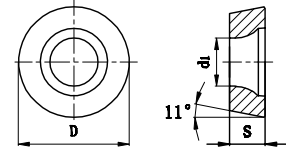

Ordering Code	Dimensions (mm)			Coated							Uncoated	Cerm-et	
	D	S	d ₁	GA4225	GA4230	GP4225	GP2115	GM2140	GK4125	GK2115	GS4130	GN9125	GP01TM
	RPET1003M0-GL	10	3.18	4.4	●	○					○		
	RPET1204M0-GL	12	4.76	4.4	●	○					○		
	RPET08T2M0-GM	8	2.78	2.94		○	○				○		
	RPET1003M0T-GM	10	3.18	4.4		●	○				○		
	RPET1204M0-GM	12	4.76	4.4	●	●	○				○		
	RPET1204M0T-GM	12	4.76	4.4		●	○				○		
	RPET1606M0T-GM	16	6.35	5.5		●	○				○		
	RPET1606M0-SM	16	6.35	5.5		○	○	○	○	○	○		
	RPET1606M0T-GH	16	6.35	5.5		●	○	○	○	○	○		
	RPEW08T2M0	8	2.78	2.94		○	○						
	RPEW1003M0	10	3.18	4.4		●	○						
	RPEW10T3M0	10	3.97	4.4									
	RPEW1003M0T	10	3.18	4.4	●	●	○						
	RPEW1204M0T	12	4.76	4.4	●	●	○						



● Stock ○ Available upon Order

Profile Milling

RP

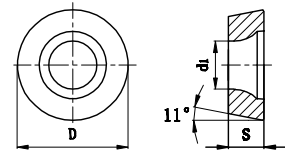







Profile Milling Inserts



Ordering Code	Dimensions (mm)			Coated								Uncoated	Cerm-et
	D	S	d ₁	GA4225	GA4230	GP4225	GP2115	GM2140	GK4125	GK2115	GS4130	GN9125	GP01TM
	RPMT10T3M0-GM	10	3.97	4.4	○	○					○		
	RPMT1003M0T-GM	10	3.18	4.4	●	●	○	●	○	○	○		
	RPMT1204M0-GM	12	4.76	4.4	●	●	○	●	○	○	○		
	RPMW1003M0T	10	3.18	4.4	●	●	○	●		○	○		
	RPMW1204M0T	12	4.76	4.4	●	●	○	●		○	○		

● Stock ○ Available upon Order

RP Series Geometry

LightCutting for General material	Medium Cutting for General material	Heavy cuttingfor General material	
			
GL	GM	GH	None
			
Design with big front rake angle makes the cutting edges sharper.	Design with medium rake angle and edge width. Combine sharp with strength	Design withflat chipbreaker makes the cutting edgestronger.	

cncmagazine.ru

Profile Milling

MPB100

Arbor

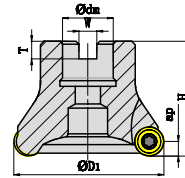

Fig1

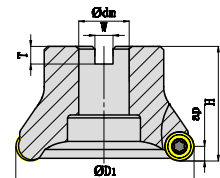

Fig2

Ordering Code	Diameters	Teeth	Dimensions (mm)					A _{pmax}	Gauge Insert	Coolant	Shape	Stock
			ΦD ₁	Φdm	H	W	T					
MPB100040R05A16RP08	40	5	40	16	40	8.4	6.3	4	RP**08T2	×	Fig1	○
MPB100040R04A16RP10	40	4	40	16	40	8.4	6.3	5	RP**1003	×	Fig1	●
MPB100050R04A22RP10	50	4	50	22	50	10.4	6.3	5	RP**1003	×	Fig1	●
MPB100050R04A22RP12	50	4	50	22	50	10.4	6.3	6	RP**1204	×	Fig1	●
MPB100063R05A22RP12	63	5	63	22	50	10.4	6.3	6	RP**1204	×	Fig1	●
MPB100063R04A22RP16	63	4	63	22	40	10.4	6.3	8	RP**1606	×	Fig1	○
MPB100080R06B27RP16	80	6	80	27	50	12.4	7	8	RP**1606	×	Fig2	●
MPB100100R07B32RP16	100	7	100	32	50	14.4	8	8	RP**1606	×	Fig2	●
MPB100125R08B40RP16	125	8	125	40	63	16.4	9	8	RP**1606	×	Fig2	○

● Stock ○ Available upon Order

Profile Milling

MPB100

Shank

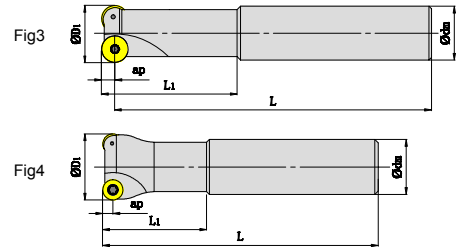

Ordering Code	Diameters	Teeth	Dimensions (mm)				Apmax	Gauge Insert	Coolant	Shape	Stock
			ΦD ₁	Φd _m	L	L ₁					
MPB100016R02P16RP08S	16	2	16	16	120	40	4	RP**08T2	×	Fig3	○
MPB100016R02P16RP08	16	2	16	16	160	60	4	RP**08T2	×	Fig3	●
MPB100020R02P20RP08	20	2	20	20	160	60	4	RP**08T2	×	Fig3	●
MPB100025R03P25RP08	25	3	25	25	160	60	4	RP**08T2	×	Fig.3	●
MPB100020R02P20RP10	20	2	20	20	160	50	5	RP**1003	×	Fig3	○
MPB100025R02P20RP10	25	2	25	20	160	50	5	RP**1003	×	Fig4	●
MPB100025R02P20RP10L	25	2	25	20	200	50	5	RP**1003	×	Fig4	○
MPB100025R02P25RP12	25	2	25	25	160	50	6	RP**1204	×	Fig3	●
MPB100032R02P25RP12	32	2	32	25	160	50	6	RP**1204	×	Fig4	●
MPB100032R02P25RP12L	32	2	32	25	200	60	6	RP**1204	×	Fig4	○
MPB100040R02P32RP16	40	2	40	32	200	80	8	RP**1606	×	Fig4	○





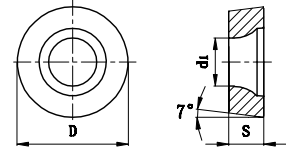

● Stock ○ Available upon Order

Profile Milling

RC









Profile Milling Inserts



Ordering Code	Dimensions (mm)			Coated								Uncoated	Cerm-et
	D	S	d ₁	GA4225	GA4230	GP4225	GP2115	GM2140	GK4125	GK2115	GS4130	GN9125	GP01TM
	RCET10T3M0-EM	10	3.97	4.4	●	●	○					○	
	RCET1204M0-EM	12	4.76	4		●	○	○	○	○	○	○	
	RCET1606M0-EM	16	6.35	5.5		○	○	○	○	○	○	○	
	RCET2006M0-EM	20	6.35	6.5		○	○	○	○	○	○	○	
	RCET1204M0-MM	12	4.76	4	●	○	○	○	○	○	○	○	
	RCET1204M0-KM	12	4.76	4		○	○						
	RCET1606M0-KM	16	6.35	5.5		○	○	○	○	○	○	○	
	RCET1204M0T-EH	12	4.76	4.4		○	○	○	○	○	○	○	
	RCET1606M0T-EH	16	6.35	5.5		○	○	○	○	○	○	○	
	RCET2006M0T-EH	20	6.35	6.5		○	○				○		
	RCET1606M0T-KH	16	6.35	5.5		○	○				○		

●Stock ○Available upon Order

RC Series Geometry

Medium Cutting for General material		Heavy cutting for General material	
			
EM	MM	EH	KH
			
Double front rake combine the cutting edge sharp with strength		Design with chamferchipbreaker and small front rake angle makes the cutting edge stronger.	

cncmagazine.ru

Profile Milling

MPC100

Arbor

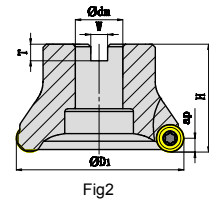
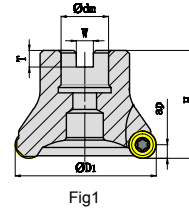

Ordering Code	Diameters	Teeth	Dimensions (mm)					A _{pmax}	Gauge Insert	Coolant	Shape	Stock
			ΦD_1	Φd_m	H	W	T					
MPC100050R04A22RC10	50	4	50	22	50	10.4	6.3	5	RC**10T3	×	Fig1	○
MPC100050R04A22RC12	50	4	50	22	50	10.4	6.3	6	RC**1204	×	Fig1	●
MPC100050R05A22RC12	50	5	50	22	50	10.4	6.3	6	RC**1204	×	Fig1	●
MPC100063R04A22RC12	63	4	63	22	50	10.4	6.3	6	RC**1204	×	Fig.1	●
MPC100063R05A22RC12	63	5	63	22	50	10.4	6.3	6	RC**1204	×	Fig1	●
MPC100063R06A22RC12	63	6	63	22	50	10.4	6.3	6	RC**1204	×	Fig1	○
MPC100080R06A22RC12	80	6	80	27	50	12.4	7	6	RC**1204	×	Fig1	○
MPC100063R04A22RC16	63	4	63	22	50	10.4	6.3	8	RC**1606	×	Fig1	●
MPC100063R05A22RC16	63	5	63	22	50	10.4	6.3	8	RC**1606	×	Fig1	●
MPC100080R05A27RC16	80	5	80	27	50	12.4	7	8	RC**1606	×	Fig1	●
MPC100080R06A27RC16	80	6	80	27	50	12.4	7	8	RC**1606	×	Fig1	●
MPC100100R06B32RC16	100	6	100	32	50	14.4	8	8	RC**1606	×	Fig2	●
MPC100080R04B27RC20	80	4	80	27	50	12.4	7	10	RC**2006	×	Fig2	○
MPC100100R06B32RC20	100	6	100	32	50	14.4	8	10	RC**2006	×	Fig2	●
MPC100125R07B32RC20	125	7	125	32	63	14.4	8	10	RC**2006	×	Fig2	●
MPC100160R08B40RC20	160	8	160	40	63	14.4	8	10	RC**2006	×	Fig2	○

●Stock ○Available upon Order

Profile Milling

MPC100

Shank

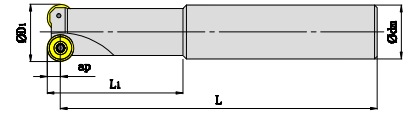



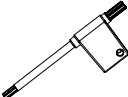

Fig3

Ordering Code	Diameters	Teeth	Dimensions (mm)				A _{pmax}	Gauge Insert	Coolant	Shape	Stock
			ΦD_1	Φd_m	L	L ₁					
MPC100020R02P20RC10	20	2	20	20	160	50	5	RC**10T3	×	Fig3	●
MPC100025R02P20RC10	25	2	25	20	160	50	5	RC**10T3	×	Fig3	●
MPC100032R02P25RC12	32	2	32	25	200	50	6	RC**1204	×	Fig3	●
MPC100040R03P32RC12	40	3	40	32	200	50	6	RC**1204	×	Fig3	●

●Stock ○Available upon Order

cncmagazine.ru

Spare Parts

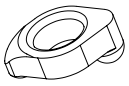
Parts	Insert Screw	Insert Spanner	Screw	plate pinch
Insert Shape				
	RD**05	SI60M2X5 730100961020	TT06P 720300960506	- -
RD**07 RD**08/RP**08	SI60M2.5X6 730100961040	TT08P 720300960508	- -	- -
	RD**10 RP**10	SI60M4X9 730100961131	TT15P 720300960510	SI60M3.5X10 730100961100
RC**10	SI60M4X9 730100961131	TT15P 720300960510	- -	- -
	RD**12 RP**12	SI60M4X10 730100961135	TT15P 720300960510	SI60M4X10 730100961135
RC**12	SI60M3.5X10 730100961100	TT15P 720300960510	- -	- -
	RD**16/RP**16 RC**16	SI60M5X13 730100961210	TT20P 720300960515	- -
RC**20	SI60M6X12 730100961502	TT25P 720300960517	- -	- -

Recommended Cutting Data

Workpiece Material	Material Hardness	Grade	Cutting Speed Vc (m/min)	Radius (IC)	mm/tooth (fz)			
					Light Cutting(L)	Medium Cutting(M)	Heavy Cutting(H)	
					GL/BL	GM/MM/EM	GH/KH/T	
P	Low Carbon Steel	≤HB180	180 (150-220)	GP2115 GA4225 GP4225 GA4230	05	0.08 (0.05-0.15)	0.10 (0.08-0.15)	0.12 (0.08-0.20)
					07 08	0.08 (0.05-0.15)	0.12 (0.08-0.18)	0.15 (0.10-0.25)
					10 12	0.15 (0.10-0.25)	0.20 (0.15-0.30)	0.25 (0.20-0.35)
					16	0.18 (0.10-0.25)	0.25 (0.15-0.35)	0.30 (0.20-0.45)
					20	0.20 (0.12-0.25)	0.30 (0.15-0.40)	0.35 (0.20-0.45)
	Carbon Steel, Alloy Steel	HB180-350	160 (140-200)	GP2115 GA4225 GP4225 GA4230	05	0.08 (0.05-0.15)	0.10 (0.08-0.15)	0.12 (0.08-0.20)
					07 08	0.08 (0.05-0.15)	0.12 (0.08-0.18)	0.15 (0.10-0.25)
					10 12	0.15 (0.10-0.25)	0.20 (0.15-0.30)	0.25 (0.20-0.35)
					16	0.18 (0.10-0.25)	0.25 (0.15-0.35)	0.30 (0.20-0.45)
					20	0.20 (0.12-0.25)	0.30 (0.15-0.40)	0.35 (0.20-0.45)
	Per-hardened Steel	HRC35-45	120 (100-160)	GP2115 GA4225 GP4225 GA4230	05	0.08 (0.05-0.15)	0.10 (0.08-0.15)	0.12 (0.08-0.20)
					07 08	0.08 (0.05-0.15)	0.12 (0.08-0.18)	0.15 (0.10-0.25)
					10 12	0.15 (0.10-0.25)	0.20 (0.15-0.30)	0.25 (0.20-0.35)
					16	0.18 (0.10-0.25)	0.25 (0.15-0.35)	0.30 (0.20-0.45)
					20	0.20 (0.12-0.25)	0.30 (0.15-0.40)	0.35 (0.20-0.45)
M	Stainless Steel (Ferrite, Martensite)	≤HB270	140 (120-180)	GM2140 GS4130 GA4225 GP4225 GA4230	05	0.08 (0.05-0.15)	0.10 (0.08-0.15)	0.12 (0.08-0.20)
					07 08	0.08 (0.05-0.15)	0.12 (0.08-0.18)	0.15 (0.10-0.25)
					10 12	0.15 (0.10-0.25)	0.20 (0.15-0.30)	0.25 (0.20-0.35)
					16	0.18 (0.10-0.25)	0.25 (0.15-0.35)	0.35 (0.20-0.45)
					20	0.20 (0.12-0.25)	0.30 (0.15-0.40)	0.35 (0.20-0.45)
	Stainless Steel (Austenite, Diphasic)	≤HB270	120 (100-160)	GM2140 GS4130 GA4225 GP4225 GA4230	05	0.08 (0.05-0.15)	0.10 (0.08-0.15)	0.12 (0.08-0.20)
					07 08	0.08 (0.05-0.15)	0.12 (0.08-0.18)	0.15 (0.10-0.25)
					10 12	0.15 (0.10-0.25)	0.20 (0.15-0.30)	0.25 (0.20-0.35)
					16	0.18 (0.10-0.25)	0.25 (0.15-0.35)	0.35 (0.20-0.45)
					20	0.20 (0.12-0.25)	0.30 (0.15-0.40)	0.35 (0.20-0.45)

Recommended Cutting Data

Workpiece Material	Material Hardness	Grade	Cutting Speed Vc (m/min)	Radius (IC)	mm/tooth (fz)								
					Light Cutting(L)	Medium Cutting(M)	Heavy Cutting(H)						
					GL/BL	GM/MM/EM	GH/KH/T						
K Grey Cast Iron	≤HB280	GK2115 GK4125 GP2115 GA4225 GP4225 GA4230	180 (150-220)	05	0.08 (0.05-0.15)	0.15 (0.08-0.15)	0.12 (0.08-0.20)						
					07 08	0.08 (0.05-0.15)	0.12 (0.08-0.18)	0.15 (0.10-0.25)					
					10 12	0.15 (0.10-0.25)	0.20 (0.15-0.30)	0.25 (0.20-0.35)					
					16	0.18 (0.10-0.25)	0.25 (0.15-0.35)	0.30 (0.20-0.45)					
					20	0.20 (0.12-0.25)	0.30 (0.15-0.40)	0.35 (0.20-0.45)					
					Nodular Cast Iron Vermicular Cast Iron	≤HB350	GK2115 GK4125 GP2115 GA4225 GP4225 GA4230	120 (100-180)	05	0.08 (0.05-0.15)	0.15 (0.08-0.15)	0.12 (0.08-0.20)	
										07 08	0.08 (0.05-0.15)	0.12 (0.08-0.18)	0.15 (0.10-0.25)
										10 12	0.15 (0.10-0.25)	0.20 (0.15-0.30)	0.25 (0.20-0.35)
										16	0.18 (0.10-0.25)	0.25 (0.15-0.35)	0.30 (0.20-0.45)
										20	0.20 (0.12-0.25)	0.30 (0.15-0.40)	0.35 (0.20-0.45)
S Heat-resistant Alloy and Titanium Alloy	HRC25-35	GS4130 GM2140	40 (30-60)	08	0.08 (0.05-0.15)	0.12 (0.08-0.18)	0.15 (0.10-0.25)						
					10 12	0.10 (0.05-0.15)	0.12 (0.08-0.20)	0.15 (0.10-0.25)					
					16	0.10 (0.05-0.15)	0.12 (0.08-0.20)	0.15 (0.10-0.25)					
					20	0.12 (0.05-0.20)	0.15 (0.08-0.25)	0.20 (0.15-0.30)					
					H Quenching Steel	HRC48-55	GP2115 GA4230	80 (60-120)	08	0.08 (0.05-0.15)	0.10 (0.08-0.15)	0.12 (0.08-0.20)	
10 12	0.15 (0.10-0.25)	0.20 (0.15-0.30)	0.25 (0.20-0.35)										
16	0.18 (0.10-0.25)	0.22 (0.15-0.35)	0.28 (0.20-0.40)										
20	0.20 (0.15-0.30)	0.25 (0.15-0.35)	0.30 (0.20-0.40)										

- Tool RPM () = (1000 X Cutting Speed) / (3.14 X Diameter Of Cutter)
- Workpiece Feed (mm/min) = Feed Per Tooth X Number Of Tooth X Tool RPM

The Relationship of recommended Feed and Depth of RD/RP/RC inserts

Insert Size (IC)	Condition	ap (mm)							
		0.1	0.5	1	1.5	2	2.5	3	4
05	Medium Cutting (M)	0.35 (0.22-0.63)	0.17 (0.08-0.26)	0.12 (0.06-0.21)	0.1 (0.05-0.17)	-	-	-	-
	Heavy Cutting (H)	0.45 (0.29-0.95)	0.2 (0.12-0.38)	0.16 (0.09-0.28)	0.14 (0.07-0.25)	-	-	-	-
07 08	Medium Cutting (M)	0.59 (0.23-0.90)	0.27 (0.10-0.41)	0.20 (0.08-0.30)	0.17 (0.06-0.26)	0.15 (0.03-0.23)	-	-	-
	Heavy Cutting (H)	0.68 (0.32-1.13)	0.31 (0.14-0.52)	0.23 (0.11-0.38)	0.19 (0.09-0.32)	0.17 (0.08-0.29)	-	-	-
10	Light Cutting (L)	0.75 (0.25-0.90)	0.34 (0.11-0.41)	0.25 (0.08-0.30)	0.21 (0.07-0.25)	0.19 (0.06-0.23)	0.17 (0.05-0.21)	-	-
	Medium Cutting (M)	0.90 (0.25-1.26)	0.41 (0.11-0.57)	0.30 (0.08-0.42)	0.25 (0.07-0.35)	0.23 (0.06-0.31)	0.21 (0.05-0.28)	-	-
	Heavy Cutting (H)	1.01 (0.35-1.51)	0.46 (0.16-0.69)	0.33 (0.12-0.50)	0.28 (0.10-0.42)	0.25 (0.09-0.38)	0.23 (0.08-0.35)	-	-
12	Light Cutting (L)	0.83 (0.28-1.10)	0.38 (0.13-0.50)	0.27 (0.09-0.36)	0.23 (0.08-0.30)	0.20 (0.07-0.27)	0.18 (0.06-0.25)	0.17 (0.06-0.23)	-
	Medium Cutting (M)	0.99 (0.28-1.38)	0.45 (0.13-0.63)	0.33 (0.09-0.45)	0.27 (0.08-0.38)	0.24 (0.07-0.34)	0.22 (0.06-0.31)	0.21 (0.06-0.29)	-
	Heavy Cutting (H)	1.10 (0.39-1.65)	0.50 (0.18-0.75)	0.36 (0.13-0.54)	0.30 (0.11-0.45)	0.27 (0.09-0.40)	0.25 (0.08-0.37)	0.23 (0.08-0.35)	-
16	Light Cutting (L)	1.14 (0.32-1.59)	0.52 (0.14-0.72)	0.37 (0.10-0.52)	0.31 (0.09-0.43)	0.27 (0.08-0.38)	0.25 (0.07-0.35)	0.23 (0.06-0.32)	0.21 (0.06-0.29)
	Medium Cutting (M)	1.27 (0.32-1.90)	0.57 (0.14-0.86)	0.41 (0.10-0.62)	0.34 (0.09-0.51)	0.30 (0.08-0.45)	0.28 (0.07-0.41)	0.26 (0.06-0.38)	0.23 (0.06-0.35)
	Heavy Cutting (H)	1.59 (0.44-2.54)	0.72 (0.20-1.15)	0.52 (0.14-0.83)	0.43 (0.12-0.69)	0.38 (0.11-0.60)	0.35 (0.10-0.54)	0.32 (0.09-0.51)	0.29 (0.08-0.46)
20	Medium Cutting (M)	1.77 (0.35-2.84)	0.80 (0.16-1.28)	0.57 (0.11-0.92)	0.47 (0.09-0.76)	0.42 (0.08-0.67)	0.39 (0.07-0.56)	0.35 (0.07-0.56)	0.31 (0.06-0.50)
	Heavy Cutting (H)	2.48 (0.50-3.90)	1.12 (0.22-0.76)	0.80 (0.16-1.26)	0.66 (0.13-1.04)	0.58 (0.12-0.92)	0.54 (0.10-0.77)	0.49 (0.10-0.77)	0.44 (0.09-0.69)

Remarks: In general, when the cutting depth is less than 25%IC using screw cutting tool.
If the cutting depth exceeds the Kr=45° series of SNEU/SEET inserts are recommended.

High Feed Milling

UD/UP



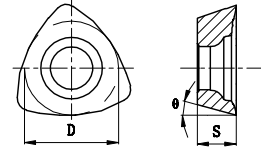





3 Edges High Feed Milling



Ordering Code		Dimensions (mm)			Coated								Uncoated	Cermet
		D	S	θ	GA4225	GA4230	GP4225	GP2115	GM2140	GK4125	GK2115	GS4130	GN9125	GP01TM
	UDET080308-MM	6.8	3.18	15	●	●	○	○	○	○	○	○		
	UDET12T312-MM	9.6	3.97	15	●	●	○	○	○			○		
	UPET170520-PM	13	5.56	11	●	●	○	○				○		
	UDMT080308T-MH	6.8	3.18	15	●	●	○	○	○			○		
	UDMT12T312T-MH	9.6	3.97	15	●	●	○	○	○	○	○	○		
	UDMW12T312T	9.6	3.97	15	●	●	○	○	○			○		

●Stock ○Available upon Order

UD/UP Series Geometry

Medium Cutting for General material		Rough Cutting for General material	
			
MM	PM	MH	None
			
Bigger rake angle makes cutting edge more sharply.	Chamfered cutting edge with rake angle is suitable for medium cutting.	Smaller rake angle makes stronger cutting edge.	Flat insert design makes strongest cutting edge.

cncmagazine.ru

High Feed Milling

MKA110

Arbor

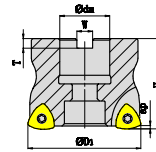

Fig1

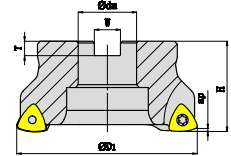

Fig2

Ordering Code	Diameters	Teeth	Dimensions (mm)					A _{pmax}	Gauge Insert	Coolant	Shape	Stock
			ΦD_1	Φd_m	H	W	T					
MKA110040R05A16UD08	40	5	40	16	40	8.4	5.6	1.0	UD**0803	×	Fig1	○
MKA110050R06A22UD08	50	6	50	22	40	10.4	6.3	1.0	UD**0803	×	Fig1	○
MKA110050R04A22UD12	50	4	50	22	40	10.4	6.3	1.5	UD**12T3	×	Fig1	●
MKA110063R05A22UD12	63	5	63	22	40	10.4	6.3	1.5	UD**12T3	×	Fig1	○
MKA110063R04A22UP17	63	4	63	22	40	10.4	6.3	2.0	UP**1705	×	Fig1	●
MKA110063R05A22UP17	63	5	50	22	40	10.4	6.3	2.0	UP**1705	×	Fig1	○
MKA110080R05A27UP17	80	5	80	27	50	12.4	7	2.0	UP**1705	×	Fig1	●
MKA110080R06A27UP17	80	6	80	27	50	12.4	7	2.0	UP**1705	×	Fig1	○
MKA110100R06B32UP17	100	6	100	32	50	14.4	8	2.0	UP**1705	×	Fig2	○

● Stock ○ Available upon Order

High Feed Milling

MKA110

Shank

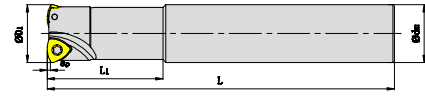

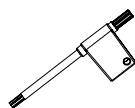

Fig3

Ordering Code	Diameters	Teeth	Dimensions (mm)				A _{max}	Gauge Insert	Coolant	Shape	Stock
			ΦD ₁	Φd _m	L	L ₁					
MKA110020R02P20UD08S	20	2	20	20	120	40	1.0	UD**0803	×	Fig3	●
MKA110020R02P20UD08	20	2	20	20	160	50	1.0	UD**0803	×	Fig3	○
MKA110025R02P25UD08S	25	2	25	20	120	40	1.0	UD**0803	×	Fig3	○
MKA110025R02P25UD08	25	2	25	25	160	50	1.0	UD**0803	×	Fig3	●
MKA110035R05P32UD08	35	5	35	32	200	50	1.0	UD**0803	×	Fig3	○
MKA110025R02P25UD12	25	2	25	25	160	50	1.5	UD**12T3	×	Fig3	●
MKA110030R03P32UD12	30	3	30	32	200	50	1.5	UD**12T3	×	Fig3	○
MKA110032R03P32UD12	32	3	32	32	200	50	1.5	UD**12T3	×	Fig3	●
MKA110-035R03P32-UD12	35	3	35	32	200	50	1.5	UD**12T3	×	Fig3	●

● Stock ○ Available upon Order

Spare Parts

Parts	Insert Screw	Insert Spanner
Insert	Shape	
		
UD**0803	SI60M2.5X6.5	TT08P
	730100961043	720300960507
UD**12T3	SI60M4X9	TT15P
	730100961131	720300960510
UP**1705	SI60M5X12	TT20P
	730100961205	720300960515

Parameters for Programing Calculations

Insert	Approximate Corner R(mm)	Remains K(mm)
UD**0803	1.8	0.58
UD**12T3	2.8	0.86
UP**1705	3.5	1.02

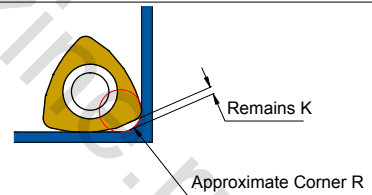

Recommended Cutting Data

Workpiece Material	Material Hardness	Grade	Cutting Speed	mm/tooth		
			Vc (m/min)	Medium Cutting(M)	Heavy Cutting(H)	
P	Mild Steel	≤HB200	GA4225 GP4225 GA4230	180 (150-200)	1.2 (0.8-1.5)	1.5 (1.0-2.0)
	Carbon Steel, Alloy Steel	≤HRC35	GA4225 GA4230 GP2115 GS4130	150 (120-180)	1.2 (0.8-1.5)	1.5 (1.0-2.0)
	Carbon Steel, Alloy Steel	HRC35-45	GA4230	120 (90-140)	1.0 (0.6-1.2)	1.2 (0.8-1.5)
M	Stainless Steel (Ferrite, Martensite)	≤HRC35	GM2140 GA4230 GS4130	120 (90-140)	0.8 (0.6-1.0)	1.0 (0.8-1.2)
K	Cast Iron Nodular Cast Iron	≤HB350	GK2115 GK4125	180 (150-200)	1.2 (0.8-1.5)	1.5 (1.0-2.0)
S	Heat-resistant Alloy and Titanium Alloy	≤HRC35	GM2140 GS4130 GA4230	40 (30-60)	0.3 (0.15-0.4)	0.4 (0.2-0.6)
H	Quenching Steel	HRC45-55	GA4230	80 (60-100)	0.2 (0.1-0.3)	0.3 (0.15-0.4)

The Relationship of Recommended Feed and Depth of UD/UP Inserts



Insert Size	ap (mm)					
	0.5	1	1.5	2	2.5	3
08	0.8 (0.6-1.2)	0.5 (0.4-0.8)	-	-	-	-
12	1.5 (1.0-2.0)	1.2 (0.8-1.5)	0.8 (0.6-1.2)	-	-	-
17	2 (1.8-2.5)	1.5 (1.0-2.0)	1.2 (0.8-1.5)	0.8 (0.6-1.2)	-	-

High Feed Milling

SDMT

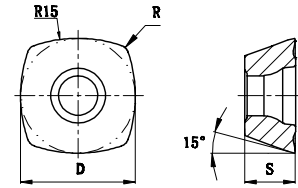



4 Edges High Feed Milling



Ordering Code	D	S	R	Coated									Uncoated	Cermet	
				GA4225	GA4230	GP4225	GP2115	GM2140	GK4125	GK2115	GS4130	GN9125	GP01TM		
	SDMT120512-GM	12.7	5.56	1.2	●	●	○	○	○	○	●	○	○		
	SDMT150512-GM	15.875	5.56	1.2	●	●	○	○	○	○	○	○	○		
	SDMT120512-GH	12.7	5.56	1.2	●	●	○	○	○	○	○	○	○		
	SDMT150512-GH	15.875	5.56	1.2	●	●	○	○	○	○	○	○	○		

● Stock ○ Available upon Order

SDMT Series Geometry

Medium Cutting for General material	Heavy Cutting for General material
	
GM	GH
	
<p>Chamfered cutting edge with rake angle is suitable for medium cutting.</p>	<p>Cutting force with special rake angle is suitable for heavy cutting.</p>

cncmagazine.ru

High Feed Milling

MKB113

Arbor

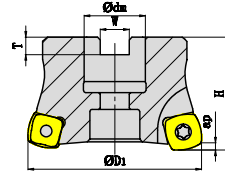
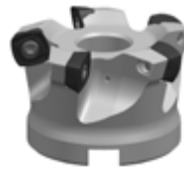

Fig1

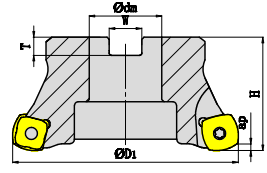

Fig2

Ordering Code	Diameters	Teeth	Dimensions (mm)					A _{pmax}	Gauge Insert	Coolant	Shape	Stock
			ϕD_1	ϕD_m	H	W	T					
MKB113050R04A22SD12	50	4	50	22	40	10.4	6.3	2.0	SDMT1205	×	Fig1	●
MKB113052R05A22SD12	52	5	52	22	40	10.4	6.3	2.0	SDMT1205	×	Fig1	○
MKB113063R04A22SD12	63	4	63	22	40	10.4	6.3	2.0	SDMT1205	×	Fig1	●
MKB113063R05A22SD12	63	5	63	22	40	10.4	6.3	2.0	SDMT1205	√	Fig1	○
MKB113063R04A22SD15	63	4	63	22	40	10.4	6.3	3.0	SDMT1505	×	Fig1	○
MKB113080R06A27SD12	80	6	80	27	50	12.4	7	2.0	SDMT1205	√	Fig1	○
MKB113080R05A27SD15	80	5	80	27	50	12.4	7	3.0	SDMT1505	×	Fig1	●
MKB113100R06A32SD15	100	6	100	32	50	14.4	8	3.0	SDMT1505	√	Fig1	○
MKB113100R06B32SD12	100	6	100	32	50	14.4	8	2.0	SDMT1205	×	Fig2	○
MKB113100R07B32SD12	100	7	100	32	50	14.4	8	2.0	SDMT1205	×	Fig2	○
MKB113100R06B32SD15	100	6	100	32	50	14.4	8	3.0	SDMT1505	×	Fig2	○
MKB113125R07B40SD15	125	7	125	40	63	16.4	9	3.0	SDMT1505	×	Fig2	○

● Stock ○ Available upon Order

High Feed Milling

MKB113

Shank

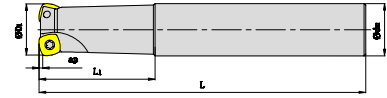

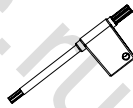

Fig3

Ordering Code	Diameters	Teeth	Dimensions (mm)					Apmax	Gauge Insert	Coolant	Shape	Stock
			ΦD_1	Φd_m	L	L ₁	-					
MKB113032R02P32SD12S	32	2	32	32	160	70	-	1.0	SDMT1205	×	Fig3	●
MKB113032R02P32SD12	32	2	32	32	200	70	-	1.0	SDMT1205	√	Fig3	●
MKB113035R03P32SD12	35	3	35	32	200	70	-	1.0	SDMT1205	√	Fig3	○
MKB113040R03P32SD12	40	3	40	32	200	70	-	1.5	SDMT1205	×	Fig3	○

● Stock ○ Available upon Order

Spare Parts

Parts	Insert Screw	Insert Spanner
Shape		
SDMT120512	SI60M4X11	TT15P
	730100961141	720300960510
SDMT150512	SI60M5X12	TT20P
	730100961201	720300960515

Parameters for Programing Calculations

Insert	Approximate Corner R(mm)	Remains K(mm)
SD**1205	4.0	0.85
SD**1505	5.0	1.05

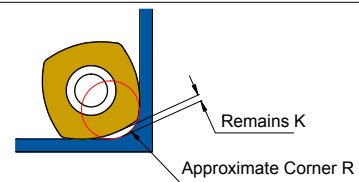

Recommended Cutting Data

Workpiece Material	Material Hardness	Grade	Cutting Speed	mm/tooth		
			Vc (m/min)	Medium Cutting(M)	Heavy Cutting(H)	
P Mild Steel	≤HB200	GA4225 GP4225 GA4230	180 (150-200)	1.2 (0.8-1.5)	1.5 (1.0-2.0)	
	Carbon Steel, Alloy Steel	≤HRC35	GA4225 GA4230 GP2115 GS4130	150 (120-180)	1.2 (0.8-1.5)	1.5 (1.0-2.0)
	Carbon Steel, Alloy Steel	HRC35-45	GA4230	120 (90-140)	1.0 (0.6-1.2)	1.2 (0.8-1.5)
M Stainless Steel (Ferrite, Martensite)	≤HRC35	GM2140 GA4230 GS4130	120 (90-140)	0.8 (0.6-1.0)	1.0 (0.8-1.2)	
K Cast Iron Nodular Cast Iron	≤HB350	GK2115 GK4125	180 (150-200)	1.2 (0.8-1.5)	1.5 (1.0-2.0)	
S Heat-resistant Alloy and Titanium Alloy	≤HRC35	GM2140 GS4130 GA4230	40 (30-60)	0.3 (0.15-0.4)	0.4 (0.2-0.6)	
H Quenching Steel	HRC45-55	GA4230	80 (60-100)	0.2 (0.1-0.3)	0.3 (0.15-0.4)	

The Relationship of recommended Feed and Depth of SDMT inserts



Insert Size	ap (mm)					
	0.5	1	1.5	2	2.5	3
12	1.8 (1.5-2.0)	1.5 (1.0-1.8)	1.0 (0.6-1.5)	0.8 (0.4-1.0)	-	-
15	2.0 (1.8-3.0)	1.8 (1.5-2.0)	1.5 (1.0-1.8)	1.0 (0.6-1.5)	0.8 (0.4-1.0)	0.6 (0.4-0.8)

Side and Face Milling

CNEU

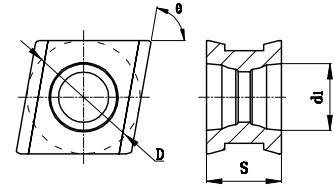
Medium Slot Width Side and Face Milling Inserts



Ordering Code	Dimensions (mm)				Coated									Uncoated	Cermet
	D	θ	S	d ₁	GA4225	GA4230	GP4225	GP2115	GM2140	GK4125	GK2115	GS4130	GN9125	GP01TM	
 CNEU070508-PM	7.6	80	5	3.4	○	○	○		○	○					
 CNEU070508-KM	7.6	80	5	3.4	○	●	○		○	●	○				

● Stock ○ Available upon Order

Side and Face Milling

MSA(110~113)

Arbor

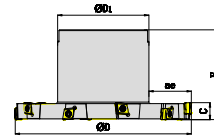

Fig1

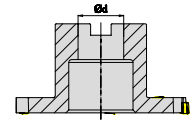

Fig2

Ordering Code	Diameters	Teeth	Dimensions (mm)						Gauge Insert	Coolant	Shape	Stock
			ϕD	C	ϕd	ae	H	ϕD_1				
MSA110080R06B27CN07	80	6	80	10	27	14	50	48	CNEU0705	×	Fig1	○
MSA110100R08B32CN07	100	8	100	10	32	19	50	58	CNEU0705	×	Fig1	○
MSA110125R10B32CN07	125	10	125	10	32	29.5	63	64	CNEU0705	×	Fig1	●
MSA110160R12B40CN07	160	12	160	10	40	43	63	70	CNEU0705	×	Fig1	○
MSA111080R06B27CN07	80	6	80	11	27	14	50	48	CNEU0705	×	Fig1	○
MSA111100R08B32CN07	100	8	100	11	32	19	50	58	CNEU0705	×	Fig1	○
MSA111125R10B32CN07	125	10	125	11	32	29.5	63	64	CNEU0705	×	Fig1	●
MSA111160R12B40CN07	160	12	160	11	40	43	63	70	CNEU0705	×	Fig1	○
MSA112080R06B27CN07	80	6	80	12	27	14	50	48	CNEU0705	×	Fig1	○
MSA112100R08B32CN07	100	8	100	12	32	19	50	58	CNEU0705	×	Fig1	○
MSA112125R10B32CN07	125	10	125	12	32	29.5	63	64	CNEU0705	×	Fig1	●
MSA112160R12B40CN07	160	12	160	12	40	43	63	70	CNEU0705	×	Fig1	○
MSA113080R06B27CN07	80	6	80	13	27	14	50	48	CNEU0705	×	Fig1	○
MSA113100R08B32CN07	100	8	100	13	32	19	50	58	CNEU0705	×	Fig1	○
MSA113125R10B32CN07	125	10	125	13	32	29.5	63	64	CNEU0705	×	Fig1	●
MSA113160R12B40CN07	160	12	160	13	40	43	63	70	CNEU0705	×	Fig1	○

●Stock ○Available upon Order

Side and Face Milling

MSA(110~113)

Shell

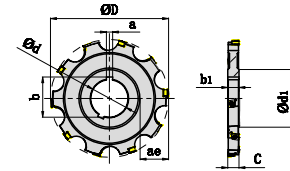

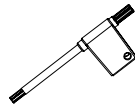

Fig3

Ordering Code	Diamet-ers	Teeth	Dimensions (mm)						Gauge Insert	Coolant	Shape	Stock
			ΦD	C	Φd	ae	b1	Φd1				
MSA110080R06K27CN07	80	6	80	10	27	19	10	40	CNEU0705	×	Fig2	○
MSA110100R08K27CN07	100	8	100	10	27	26	10	46	CNEU0705	×	Fig2	○
MSA110125R10K40CN07	125	10	125	10	40	34	10	55	CNEU0705	×	Fig2	○
MSA110160R12K40CN07	160	12	160	10	40	51	10	55	CNEU0705	×	Fig2	○
MSA111080R06K27CN07	80	6	80	11	27	19	11	40	CNEU0705	×	Fig2	○
MSA111100R08K27CN07	100	8	100	11	27	26	11	46	CNEU0705	×	Fig2	○
MSA111125R10K40CN07	125	10	125	11	40	34	11	55	CNEU0705	×	Fig2	○
MSA111160R12K40CN07	160	12	160	11	40	51	11	55	CNEU0705	×	Fig2	○
MSA112080R06K27CN07	80	6	80	12	27	19	12	40	CNEU0705	×	Fig2	○
MSA112100R08K27CN07	100	8	100	12	27	26	12	46	CNEU0705	×	Fig2	○
MSA112125R10K40CN07	125	10	125	12	40	34	12	55	CNEU0705	×	Fig2	○
MSA112160R12K40CN07	160	12	160	12	40	51	12	55	CNEU0705	×	Fig2	○
MSA113080R06K27CN07	80	6	80	13	27	19	13	40	CNEU0705	×	Fig2	○
MSA113100R08K27CN07	100	8	100	13	27	26	13	46	CNEU0705	×	Fig2	○
MSA113125R10K40CN07	125	10	125	13	40	34	13	55	CNEU0705	×	Fig2	○
MSA113160R12K40CN07	160	12	160	13	40	51	13	55	CNEU0705	×	Fig2	○

●Stock ○Available upon Order

Spare Parts

Parts		Insert Screw	Insert Spanner
Insert	Shape		
	CN*U0705	SI60M3X8 730100961075	TT09P 720300960511

Recommended Cutting Data

	Workpiece Material	Material Hardness	Grade	Cutting Speed	mm/tooth
				(m/min)	Medium Cutting(M)
P	Mild Steel	≤HB200	GA4225 GA4230 GP4225	180 (200-220)	0.1 (0.05-0.15)
	Carbon Steel, Alloy Steel	≤HRC35	GA4225 GA4230 GP4225	160 (140-180)	0.08 (0.05-0.12)
	Carbon Steel, Alloy Steel	HRC35-45	GA4225 GA4230 GP4225	140 (120-160)	0.08 (0.05-0.12)
M	Stainless Steel (Ferrite, Martensite)	≤HRC35	GA4230 GM2140	120 (90-140)	0.06 (0.08-0.10)
K	Cast Iron Nodular Cast Iron	≤HB350	GK4125 GK2115	200 (180-220)	0.1 (0.02-0.15)

Side and Face Milling

SNEX

Narrow Slot Width Side and Face Milling Inserts

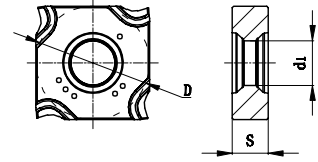

Ordering Code	Dimensions (mm)			Coated								Uncoated	Cermet
	D	S	d ₁	GA4225	GA4230	GP4225	GP2115	GM2140	GK4125	GK2115	GS4130	GN9125	GP01TM
	SNEX1202-GM	12.7	2.3	5.2	○	●	○				○		
	SNEX1203-GM	12.7	3	5.2	○	●	○				○		
	SNEX12T3-GM	12.7	3.5	5	○	●	○				○		
	SNEX1204-GM	12.7	4	5	○	●	○			●			
	SNEX12T4-GM	12.7	4.5	5	○	●	○			●			

● Stock ○ Available upon Order

Side and Face Milling

MSA(104~108)

Arbor

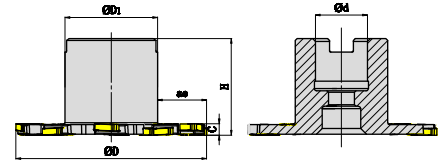
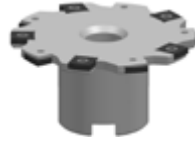

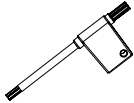

Fig1

Ordering Code	Diameters	Teeth	Dimensions (mm)						Gauge Insert	Coolant	Shape	Stock
			ΦD	C	Φd	ae	H	ΦD_1				
MSA104100R10A27SN12	100	10	100	4	27	23	50	48	SNEX1202	×	Fig1	○
MSA105100R10A27SN12	100	10	100	5	27	23	50	48	SNEX1203	×	Fig1	○
MSA106100R10A27SN12	100	10	100	6	27	23	50	48	SNEX12T3	×	Fig1	●
MSA107100R10A27SN12	100	10	100	7	27	23	50	48	SNEX1204	×	Fig1	○
MSA108100R10A27SN12	100	10	100	8	27	23	50	48	SNEX12T4	×	Fig1	○

●Stock ○Available upon Order

Spare Parts

Parts	Insert Screw	Insert Spanner
Insert	Shape	
		
SNEX1202	M4X3.2	TT09P
	730100960014	720300960511
SNEX1203	M4X4.2	TT09P
	730100960015	720300960511
SNEX12T3	M4X5.2	TT15P
	730100960016	720300960510
SNEX1204	M4X6.2	TT15P
	730100960017	720300960510
SNEX12T4	M4X7.2	TT15P
	730100960018	720300960510

Recommended Cutting Data



	Workpiece Material	Material Hardness	Grade	Cutting Speed	mm/tooth
				(m/min)	Medium Cutting(M)
P	Mild Steel	≤HB200	GA4225 GA4230 GP4225	180 (100-250)	0.1 (0.08-0.25)
	Carbon Steel, Alloy Steel	≤HRC35	GA4225 GA4230 GP4225	150 (80-250)	0.1 (0.08-0.25)
	Carbon Steel, Alloy Steel	HRC35-45	GA4225 GA4230 GP4225	120 (80-250)	0.1 (0.08-0.25)
M	Stainless Steel (Ferrite, Martensite)	≤HRC35	GA4230	120 (80-250)	0.1 (0.05-0.15)
K	Cast Iron Nodular Cast Iron	≤HB350	GK4125	140 (80-250)	0.1 (0.05-0.15)

Chamfer Milling

SPMT

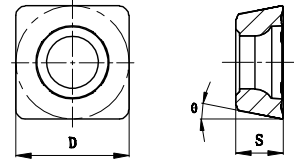
Chamfer Milling Inserts



Ordering code	D	S	θ	Coated									Uncoated	Cermet
				GA4225	GA4230	GP4225	GP2115	GM2140	GK4125	GK2115	GS4130	GN9125	GP01TM	
 SPMT09T308-CM	9.53	3.97	11	●	●	○	○	○	○	●				
 SPMT120408-CM	12.7	4.76	11	●	●	○	○	○	○	●				

● Stock ○ Available upon Order

Chamfer Milling

MCA130

Weldon

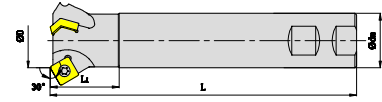

Fig1

Ordering Code	Diameters	Teeth	Dimensions (mm)				ap	Gauge Insert	Coolant	Shape	Stock
			ΦD	Φdm	L	L_1					
MCA130025R02W25SP09	25	2	25	25	120	40	3	SPMT09T308-CM	×	Fig1	●
MCA130032R03W32SP12	32	3	32	32	180	40	4.5	SPMT120408-CM	×	Fig1	●

●Stock ○Available upon Order

MCA145

Weldon

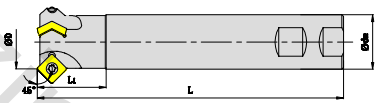
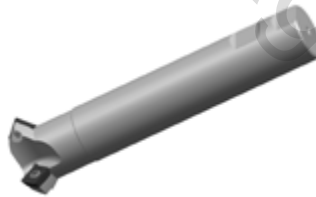

Fig2

Ordering Code	Diameters	Teeth	Dimensions (mm)				ap	Gauge Insert	Coolant	Shape	Stock
			ΦD	Φdm	L	L_1					
MCA145025R02W25SP09	25	2	25	25	120	40	5	SPMT09T308-CM	×	Fig2	●
MCA145032R03W32SP12	32	3	32	32	180	40	7	SPMT120408-CM	×	Fig2	●

●Stock ○Available upon Order

MCA160

Weldon

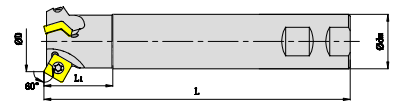
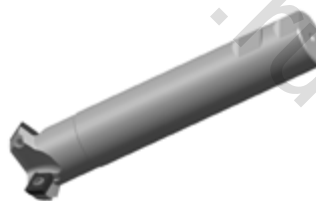

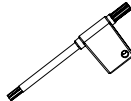

Fig3

Ordering Code	Diameters	Teeth	Dimensions (mm)				ap	Gauge Insert	Coolant	Shape	Stock
			ΦD	Φdm	L	L_1					
MCA160025R02W25SP09	25	2	25	25	120	40	6	SPMT09T308-CM	×	Fig3	●
MCA160036R03W32SP12	32	3	36	32	180	40	8	SPMT120408-CM	×	Fig3	●

●Stock ○Available upon Order

Spare Parts

Parts	Insert Screw	Insert Spanner	
Insert	Shape		
	SPMT09T308-CM	SI60M4X9	TT15P
SPMT120408-CM	SI60M5X10	TT20P	

Recommended Cutting Data



	Workpiece Material	Material Hardness	Grade	Cutting Speed	mm/tooth	
				(m/min)	Medium Cutting(M)	Heavy Cutting(H)
P	Mild Steel	≤HB200	GA4225 GA4230	180 (150-200)	0.25 (0.1-0.4)	0.4 (0.1-0.5)
	Carbon Steel, Alloy Steel	≤HRC35	GA4225 GA4230	150 (120-180)	0.3 (0.1-0.4)	0.4 (0.1-0.5)
	Carbon Steel, Alloy Steel	HRC35-45	GA4225 GA4230	120 (80-150)	0.3 (0.1-0.4)	0.4 (0.1-0.5)
M	Stainless Steel (Ferrite, Martensite)	≤HRC35	GM2140	120 (80-160)	0.3 (0.1-0.4)	0.4 (0.1-0.5)
K	Cast Iron Nodular Cast Iron	≤HB350	GK4125	130 (90-160)	0.3 (0.1-0.4)	0.4 (0.1-0.5)
S	Heat-resistant Alloy and Titanium Alloy	≤HRC35	GA4230	40 (30-60)	0.2 (0.1-0.3)	0.3 (0.15-0.35)
H	Quenching Steel	HRC45-55	GA4230	80 (60-100)	0.1 (0.1-0.2)	0.2 (0.15-0.25)

Case Studies

Face Milling



SNEU Inserts +MFB145/245 Cutter

Workpiece Materia	45# (HRC22)	
Processing way	Face milling, dry cutting	
Cutting Parameters	Vc=250 m/min, fz=0.2 mm/t, ap =2mm , ae=25mm	
Insert and cutter	SNEU1206ANEN-GM-GA4230 MFB245-063R06A22-SN12	
Remark	The tool life target is 35 minutes.	

HNEX Inserts +MFB160/260 Cutter

Workpiece Materia	HT250 (HB180-230)	
Processing way	Face milling, medium-finishing, wet cutting	
Cutting Parameters	Vc=180 m/min, fz=0.4 mm/t, ap =0.35mm	
Insert and Cutter	HNEX090516-KR-GK4125 HNEX090502-WC-GK4125 MFB160-125R15B40-HN09	

Case Studies

High Feed Milling

SDMT Inserts and MKB113 Cutter

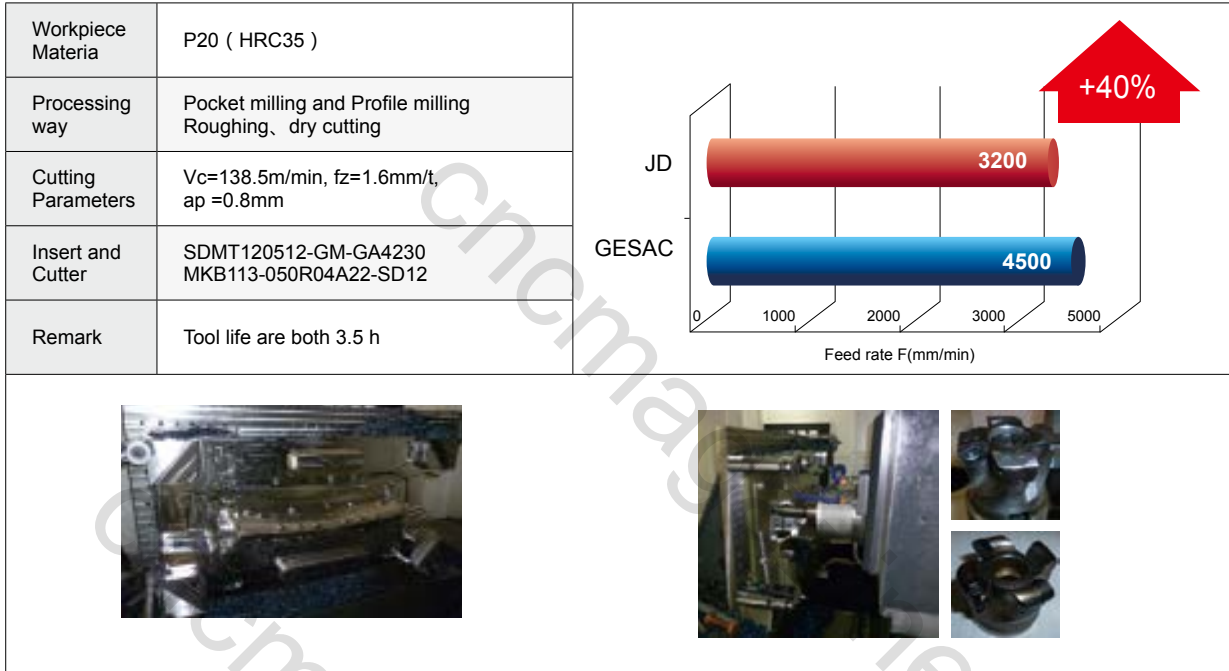

Side and Face Milling

CNEU Inserts and MSA110-113 Cutter

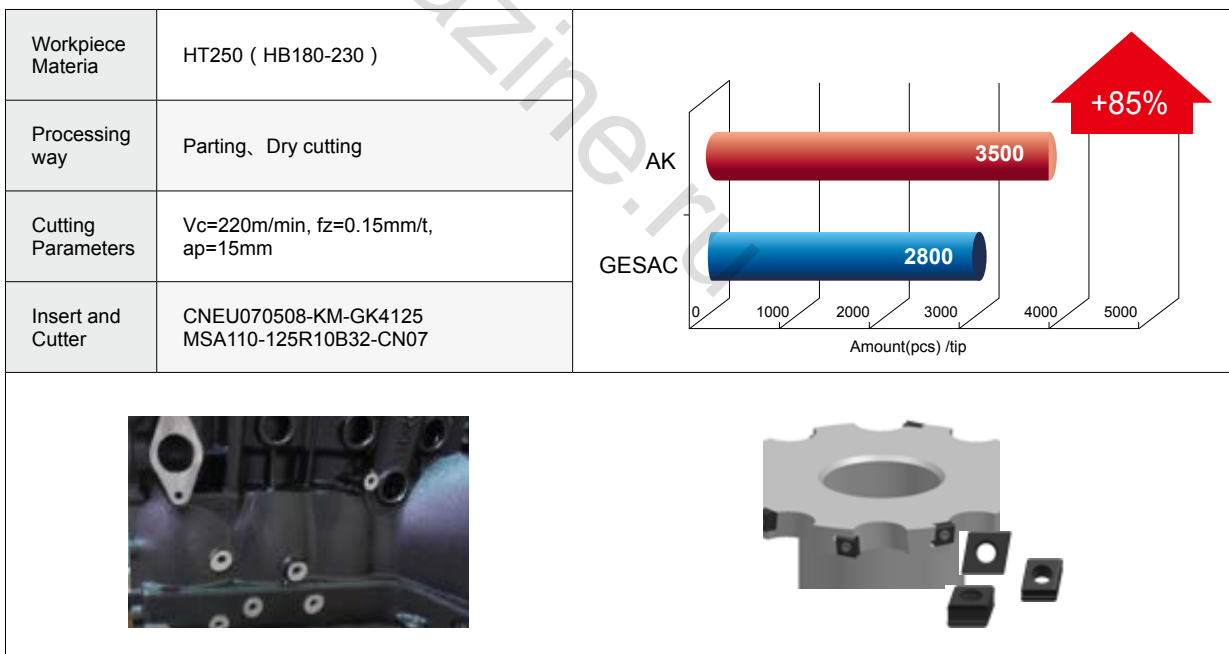

The background of the page is a close-up photograph of several solid carbide endmills. The tools are arranged in a diagonal pattern, showing their various flutes and cutting edges. Some tools have a dark, metallic finish, while others have a distinct golden-brown or copper-colored coating. The lighting highlights the sharp edges and the intricate details of the tool geometry.

SOLID CARBIDE ENDMILLS

GESAC Coating

Coating Characteristic

Coatings	Microhardness (HV0.05)	Coefficient Friction	Max. service Temperature (°C)	Characteristic and Application
AlCrN	3200	0.45	1100	High oxidation resistance, extremely good of high temperature abrasion resistance, suitable for ordinary steel, low hardness of die steel or titanium alloy dry milling.
AlCrSiN	3300	0.4	1100	Specially designed for milling, high oxidation resistance, good balance of abrasion resistance and toughness, versatility is extremely high, suitable for ordinary steel under HRC55, die steel and titanium alloy milling.
TiAlN	2900	0.35	900	Super-high micro hardness and fine-grain, suitable for stainless steel, some high hard steel drying cutting and titanium alloy milling.
AlTiN Nano	3000	0.45	900	Extremely crystal texture control, good balance of micro hardness and toughness, universal milling and drilling coatings, suitable for stainless steel, high hard steel moderately high speed and high feed cutting.
AlCrN/TiSiN	3100	0.35	1100	High oxidation resistance, good hot hardness, good toughness, and super-smooth surface, suitable for stainless steel and cast iron drilling.
AlTiN/TiSiN Multilayer	3300	0.35	1100	Super high thermal-stability, super toughness, bit general coating, especially suitable for ordinary steel drilling.
TiAlCrSiN	4000	0.35	1100	High hardness, high oxidation resistance and hot hardness, suitable for high hard steel above 55HRC milling.
Normal Diamond Coating	8500	-	700	High hardness, thermal conductivity and wear resistance, suitable for graphite machining.
Ultra-fine Grain Diamond Coating	8000	-	700	Smooth surface, good self-lubricity, hardness, thermal conductivity and wear resistance, suitable for nonferrous materials, carbon fiber composite machining, etc.

Position of Main PVD Nano-structure Coating

PVD coating provides for superior control of coating grain size (from 10nm to 500nm), achieves excellent hardness, good oxidation resistant, and improved reduction of the coefficient of friction.

Max. service Temperature (°C)

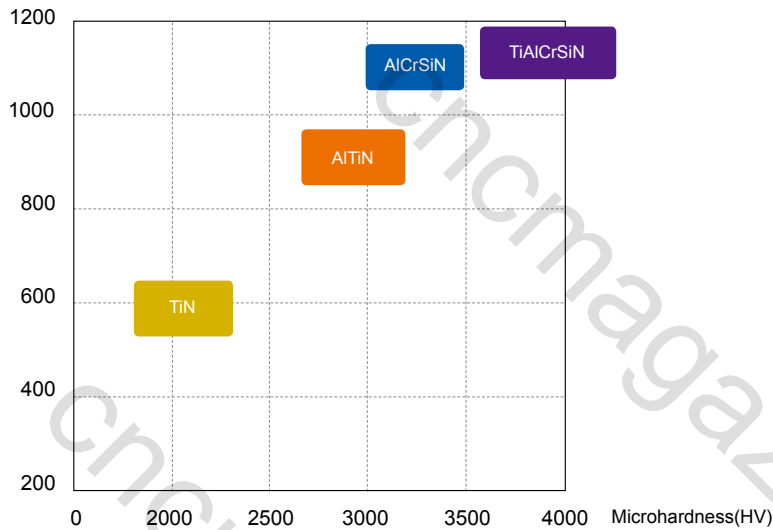

Microhardness and Max. Service Temperature

Coefficient Friction

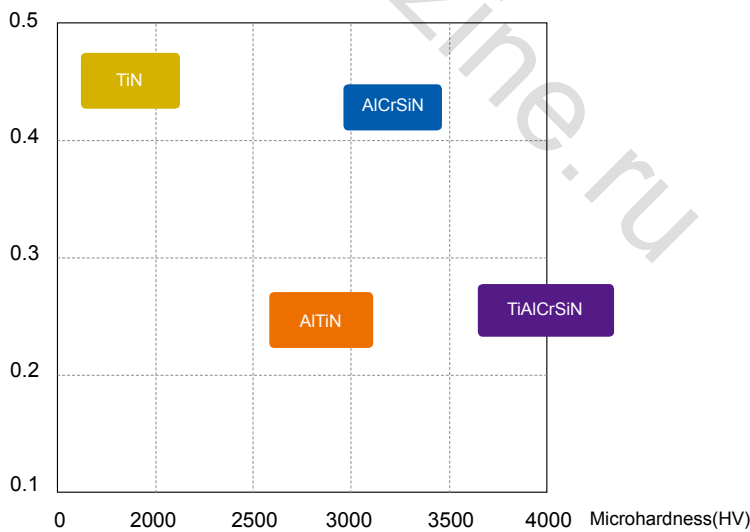

Microhardness and Coefficient of Friction

Universal High Performance Coating AlCrSiN

- Productivity increase due to significantly higher cutting speed and feed for application in a wide range of materials. Significantly enhance productivity.
- Particular design of structure brings good balance between toughness, thermo-shock stability and residual stress.

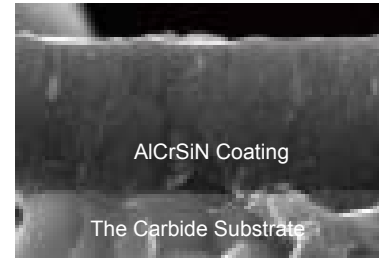

SEM Photograph of Coating

High Hardness Coating TiAlCrSiN

- Micro hardness up to 4000HV, with good wear resistance.
- Special transition layer design to ensure the high bonding strength between high hardness coating and substrate, adhesion of up to 100N.
- Nano composite coating design, have super strong oxidation resistance, oxidation starts at temperatures as high as 1100°C, high temperature stability

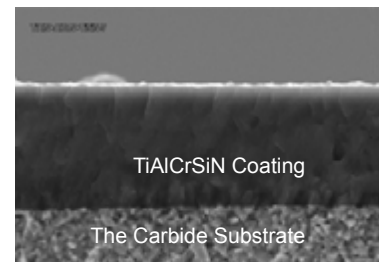

SEM Photograph of Coating

Nano Coating AlTiN

- High aluminum content provides excellent hot hardness and oxidation resistance.
- Special method optimizes the structure of coating, significantly improve stability, reducing the number of surface droplet.

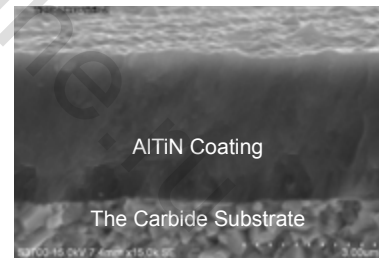

SEM Photograph of Coating

Ultra-Fine Grain Diamond Coating

- High purity diamond coating, with hardness up to 80GPa.
- Ultra smooth and shiny surface, low coefficient friction.
- Suitable for finish machining nonferrous materials, such as graphite, aluminum, carbon fiber, ceramic, etc.





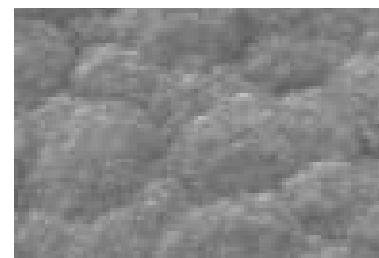





























Cross-section Image













SEM Photograph of Coating

Guidelines to Icons

Mark	Description
Shank	 ISO Standard Shank
	 ISO Standard Shank
Coating	 AlCrN Coating
	 AlCrSiN Coating
	 TiAlN Coating
	 Nano Coating AlTiN
	 AlCrN/TiSiN Coating
	 Nano Coating AlTiN/TiSiN
	 TiAlCrSiN
	 Normal Diamond Coating
	 Ultra-Fine Grain Diamond Coating
Cutting Condition	 For Side Milling
	 For Slotting
	 For Profile Milling
Helix	 -20° Helix
	 15° Helix
	 20° Helix

Mark	Description
Helix	 28° Helix
	 30° Helix
	 35° Helix
	 40° Helix
	 45° Helix
	 Variable Helix
	 Variable Helix
	 Variable Helix
	 Variable Helix
	 Variable Helix
No. of Flutes	 1 Flute Endmills
	 2 Flute Endmills
	 3 Flute Endmills
	 4 Flute Endmills
	 5 Flute Endmills
	 6 Flute Endmills
	 12 Flute Endmills

Mark	Description
Endteeth Type	 Square
	 Corner Radius
	 Ballnose
	 Square with Chamfer
Workpiece Material	 Steels
	 Stainless Steels
	 Cast Iron
	 Non-ferrous Materials
	 Heat-resistant Super Alloys, Titanium Alloys
	 High Hardened Materials

Solid Carbide Endmills Identify System

UP210 -



Workpiece	①Code of Series	Series Description
Steel, Cast Iron	UP100	Suitable for Steels&Cast Iron(≤35HRC)
	UP210	Suitable for Steels&Cast Iron(≤48HRC)
	SP210	Suitable for High Efficiency Machining of Steels & Cast Iron(≤48HRC)
	UPR100	Suitable for Roughing of Steels & Cast Iron(≤48HRC)
	UPN210	NEW Suitable for Roughing of Steels & Cast Iron(≤48HRC)
	UPM100	Suitable for Pocket Milling of Steels & Cast Iron(≤48HRC)
Stainless Steel	US200	Suitable for General Machining of Stainless Steel
	US300	Suitable for General Machining of Stainless Steel
	SS200	Suitable for General Machining of Stainless Steel
Aluminium Alloy	UA100	Suitable for General Machining of Aluminium Alloy
	UA160	Suitable for General Machining of Aluminium Alloy
	SA100	NEW Suitable for High Efficiency Machining of Aluminium Alloy
	SA300	Suitable for high efficiency machining of aerospace Aluminium Alloys
	SA310/SA360	Suitable for high efficiency machining of aerospace Aluminium Alloys
Graphite	SG200	Suitable for High Speed Machining of Graphite
Composite Materials	SD200	Suitable for Composite Material
Heat Resistant Super Alloys	SN200	Suitable for High Efficiency Machining of Heat Resistant Super Alloys
Titanium Alloys	ST200	ST200 Endmills for High Performance Machining of Titanium Alloys
	ST260	ST260 Endmills High Performance Machining of Titanium Alloys
	ST300	ST300 Endmills for High Efficiency Machining for Titanium Alloys
High Hardened Material	SH160	Suitable for Machining of Hardened Steels (48-55HRC)
	SH200-H	Suitable for General Machining of Hardened Steels (35-60HRC)
	SH300-H	NEW Suitable for Exclusive Machining of Hardened Steels (45-70HRC)
	FH200-H	NEW Suitable for High Feed Machining of Hardened Steels (35-65HRC)
	SHM100	Suitable for Micro Machining of Hardened Steels (48-56HRC)

S

S

2-

060

09

②Endteeth Type	
S	Square
B	Ballnose
R	Cornor Radius
C	Square End with Chamfer

③Length of Flute	
N	Reduce Neck
H	Long Shank
L	Long Flute
S	Short Flute
Blank	Standard

④No. of Flutes	
2	2
3	3
4	4

⑤Diameter	
0.6mm	006
6mm	060
10mm	100

⑥Code Characteristic	
1	Square End\Ballnose: a. Neck Length b. Flute Length 6-06 10-10
2	Cornor Radius r0.2-02 r1-10
3	Miniature: a.Neck Length : 1-01 10-10 b.Flute Length (*10) : 0.8-08 1.6-16
4	Square End with Chamfer : C0.03-03 C0.13-13

Small & Cavity Endmills Indentify System

SPM200



Workpiece	①Code of Series	Series Description
Steel, Cast Iron Copper Alloys , High Hardened Material	SPM200	 Suitable for High Efficiency Machining of Small & Deep-Cavity (≤55HRC)

R N 2 - 1 - 4 - 0.1 - V

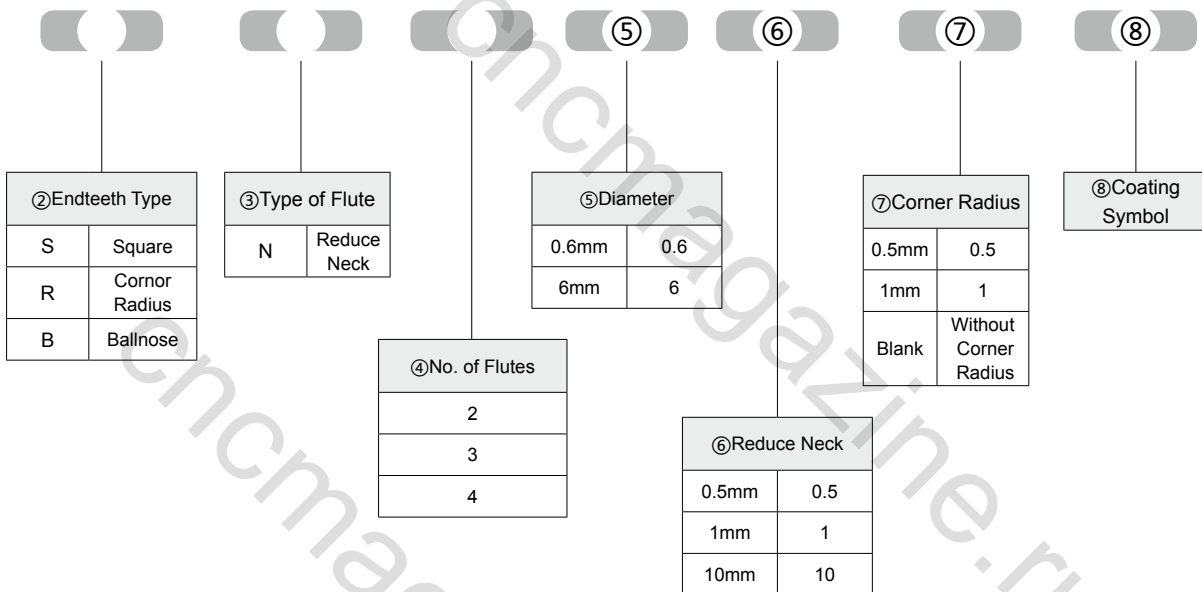

Application Summary Of Solid Carbide Endmills

ISO Material Group	MC GESAC		General Machining		Roughing	High Efficiency Machining		High Speed Machining		Micro Machining
P	1 2 3 4	Carbon Steel, Alloy Steel (< 35HRC)	UP100	UP210 SH200-H	UPR100 UPN210 NEW	SP210	SH200-H	UPM100 SPM200 NEW		
	5	Alloy Steel (35-48HRC)								
	6	PH, Ferritic, Martensitic Steel (< 35HRC)	UP100		UPR100 UPN210 NEW					
M	1 2 3	Stainless Steel	US200	US300		SS200		SPM200		
K	1 2	Grey Cast Iron, Nodular Cast Iron (< 32HRC)	UP100	UP210	UPR100	SP210		SPM200 NEW		
	3	High-alloy Cast Iron (35-45HRC)								
N	1 2	Wrought Aluminium Alloys/ Cast Aluminium Alloys (Si ≤ 12%)	UA100	UA160		SA300 SA100 NEW	SA310	SA360	SPM200 NEW	
	3	Cast Aluminium Alloys (Si > 12%)								
	4	Copper Alloys (< 200HB)	UA100	UA160						
	5	Graphite, Composite Material	SD200				SG200			
S	1 2 3	Heat-resistant Alloys (< 450HB)	SN200						SPM200 NEW	
	4	Titanium Alloys (< 400HB)	ST200		ST300	ST260	ST300			
H	1	Hardened Steel (45-55HRC)	SH160	SH200-H			SH200-H	SH300-H NEW	SHM100 SPM200 NEW	
	2	Hardened Steel (55-60HRC)			FH200-H NEW	FH200-H NEW				
	3 4	Hardened Steel (> 60HRC)								

Series Introduction

▼ UP100 Endmills for General Purpose

- Suitable for steels & cast iron ($\leq 35\text{HRC}$)
- Sharp cutting edge design meets soft material cutting.



▲ UP210 Endmills for General Purpose

- Suitable for steels & cast iron ($\leq 48\text{HRC}$).
- High performance AlCr series coating with high temperature resistance and high wear resistance.
- Adapt to oil mist, water, oil, air cooling and other cooling conditions.

▼ UPN210 Endmills for Rough Application

- Suitable for roughing machining of steels & cast iron ($\leq 48\text{HRC}$).
- Cutting edge with Special chip-breaking design, suitable for groove and side wall roughing.



▲ SP210 Endmills for High Efficiency Efficient Machining

- Suitable for high efficiency efficient machining of steels & cast iron ($\leq 48\text{HRC}$).
- Variable helix angle and unequal flute pitch with excellent anti-vibration capacity.
- Applicable to high efficiency efficient machining of large cutting depth (a_p), large cutting width (a_w) (Machine with good rigidity).

Series Introduction

▼ US300 Endmills for General Machining of Stainless Steel

- Suitable for rough milling, semi-finishing and finishing of stainless steel (<280HB).
- Design for the small depth/large width in face milling, large depth/small width in side milling, less than 0.3D in shallow slotting.



▲ US200 Endmills for General Machining of Stainless Steel

- Suitable for general machining of stainless steel (<280HB).
- Special edge design effectively solves the crumbs.
- Water , oil cooling are the best cooling methods.

▼ UPM100 Endmills for Micro Machining

- Suitable for pocket milling of steels&cast iron (≤48HRC).
- Longer neck design, prevents collisions with workpiece during deep pocket milling of mold rib areas.



▲ SS200 Endmills for High Efficiency Efficient Milling of Stainless Steel

- Suitable for high efficiency efficient rough milling and semi-finishing milling of stainless steel (< 280HB) .
- Variable Bottom edge variation and unequal helix angle and unequal flute pitch have with excellent anti-vibration capacity, and ensure high surface precision.
- Applicable for high efficiencyt machining at large cutting depth (ap), large cutting width (ae), with high metal removal rate.

Series Introduction

▼ UA100 Endmills for General Machining of Aluminum Alloy and Copper Alloy

- Suitable for aluminum alloy ($Si \leq 12\%$) and copper alloy ($< 200HB$) general processing.
- Special edge design prevents vibration and effectively solves the crumbs.
- Water cooling is the best cooling method.



▲ UA160 Endmills for General Machining of Aluminum Alloy and Copper Alloy

- Suitable for roughing, semi-finishing and finishing of aluminum alloy ($Si \leq 12\%$) and copper alloy ($< 200HB$).
- Special edge design prevents vibration.
- Special edge preparation ensures good surface quality.

▼ SA100 Endmill for High Efficiency Efficient Milling of Aluminum Alloy

- Suitable for high efficiency efficient rough milling and semi-finishing milling of aluminum alloy ($Si \leq 12\%$)
- Unique groove design and rake face polishing process enhance chip removal performance and meet needs of high efficient processing
- Applicable for high efficiency efficient machining at large cutting depth (ap), large cutting width (ae), with high metal removal rate



▲ SA310/SA360 Endmills for High Speed Machining of Aerospace Aluminium Alloy

- Suitable for high speed and high efficient machining of aerospace aluminium alloys
- Ultra-fine cemented carbide with high wear resistance and toughness
- Special design and precision manufacture with balance Dynamic balance performance $N=25000RPM$, $G2.0$
- SA360 series with inner coolant holes provide more effective cooling performance to realize high speed machining.
- Unique sharp edges with light and smooth cutting performance improve processing efficiency and workpiece surface quality.
- Extremely high efficient cavity milling with metal removal rate up to 800cc/min

Series Introduction

▼ SD200 Endmills for Machining of Composite Material

- Suitable for side milling and slotting milling of Composite Material
- Diamond coating prolongs cutting tool life
- Left and right staggered tooth design reduces and eliminates burr and delamination on the workpiece top and bottom surface.



▲ SG200 Endmills for High Speed Machining of Graphite

- Diamond coating and enhanced adhesion between coating and substrate provide high adhesion and tool toughness;
- High-purity diamond coating film with good wear resistance ensures long-life processing;
- Suitable for semi-finishing and finishing of graphite partworkpieces, such as graphite electrode and graphite products. Air cooling is recommended.

▼ SA300 Endmills for High Efficiency Machining of Aerospace Aluminium Alloys

- Suitable for high efficiency machining of aerospace aluminium alloys.
- Ultra-fine cemented carbide, high wear-resistance and toughness.
- Unique sharp cutting edges provide increased performance in smoothness efficiency and finishing.
- Extremely high efficient cavity milling with metal remove rate up to 600cc/min.



▲ SN200 Endmills for High Efficiency Machining of Heat Resistant Alloys

- Suitable for rough, semi-finish and finish machining of Heat Resistant Alloys.
- Special edge design ensures high rigidity and excellent anti-vibration performance.
- Special end cutting edge circumference relief angle improves edge strength and guarantees surface quality;
- High pressure water cooling and gas cooling are the best cooling methods.

Series Introduction

▼ SH160 Endmills for Hardened Steels(48-55HRC)

- High hardness and toughness substrate, special angle design, suitable for hardened steel processing.
- For finishing of hardened steels(48-55HRC)
- Recommended to use air or oil mist cooling.



ST200 Endmills for High Performance Machining of Titanium Alloys ▲

- Suitable for high performance machining of aerospace titanium alloys.
- Ultra-fine cemented carbide substrate, special R coating and advanced edge processing prolong tool life.
- Variable helix angle flute pitch and unequal flute pitch lead improve anti-vibration performance and surface quality.
- Apply Special for large depth & small width in side milling and cavity milling.

▶ ST260 Endmills with internal cooling for High Performance Machining of Titanium Alloys

- Suitable for high performance machining of aerospace titanium alloys with internal cooling.
- Variable flute pitch helix angle and unequal lead flute pitch improve anti-vibration performance and cutting stability
- Special Y type internal cooling holes design ensures excellent cooling effect and smooth chip evacuation.
- Comparing with ST200, ST260 Endmills allows higher cutting speed & cutting depth, and ensures longer tool life.



Series Introduction

▼ SHM100 Endmills for Small & Cavity Milling of Hardened Steels

- Special angles, with reduced neck to prevent collisions , suitable for deep cavity micro-processing of hardened steels(48-56HRC).
- Recommended to use air or oil mist cooling.

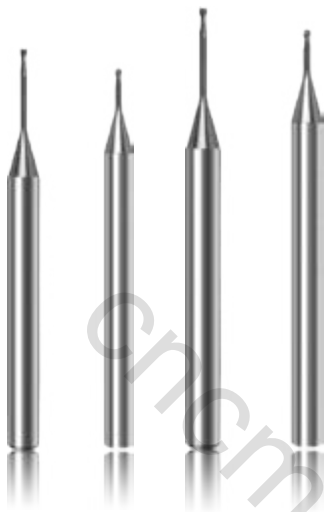

ST300 Endmills with internal cooling for ▲ High Efficiency Efficient Machining for Titanium Alloys

- Suitable for high efficiency efficient machining of aerospace titanium alloys
- Ultra-fine cemented carbide substrate, special R coating and advanced edge processing technology, prolong tool life
- Unequal flute spacing and arc edge relief design , ensure excellent anti-vibration performance and high surface precision.
- Special internal cooling holes and U type groove design, ensure excellent cooling effect, chip evacuation performance and high material removal rate.
- Suitable for high efficiency efficient machining at large depth & large width , realizing integration of rough and finishing milling

▶ SH200-H Endmills Optimized for Hardened Steels

- Suitable for Semi-Finishing and Finishing of 35~60HRC Hardened Steels;
- High strength, high toughness matrix materials base material with newly developed coating, lengthens the tool life significantly
- Recommend to use air cooling.



Series Introduction



◀ SH300-H Exclusive Use for Hardened Steels

- Suitable for Semi-Finishing and Finishing of 45~70HRC Hardened Steels;
- Carbide substrate with high strength and toughness combined with new coating significantly lengthens the tool life.
- Special tool type design and high precise quality control ensure excellent machining for hardened steels material.

▼ FH200-H Exclusive Use for High Feed Machining Hardened Steels







































- Dedicated to high feed rough machining of 35~65HRC Hardened Steels
- Special-purpose tool type design realizes thin cutting effect, high feed machining, improves the processing efficiency.
- Latest Super Fine Carbide substrate with hard coating ensures high wear-resistance and high thermal stability under various working conditions.



SPM200 Endmills for Small & Cavity Milling ▲

- Suitable for deep cavity micro-processing of carbon steel, alloy steel, hardened steel, copper & aluminum alloys etc. in precision mold industry, which hardness is less HRC55.
- High precision diameter, ballnose profile, R profile and shank (h5).
- High performance AlCrSiN nano coating, high temperature resistance and high wear resistance.
- Special angles with reduced neck design.



















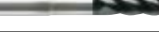









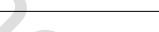







Endmills Index-Characteristic of Flute

No.of Flutes	Coat- ing	Description	Type	Diameter Range	Dimen- sion Page	Cutting Parame- ters Page
Square						
	TiAlN	2 Flute, Stub Length 	UP100-SS2	D1 ~ D16	150	421
	TiAlN	2 Flute, Standard Length 	UP100-S2	D1 ~ D20	151	421
	TiAlN	2 Flute,with Long Flute Length 	UP100-SL2	D2 ~ D20	153	421
	TiAlN	2 Flute, with Long Shank Length 	UP100-SH2	D1 ~ D20	154	421
	TiAlN	3 Flute, Standard Length 	UP100-S3	D1 ~ D25	155	421
	TiAlN	4 Flute, Standard Length 	UP100-S4	D1 ~ D20	156	422
	TiAlN	4 Flute,with Long Flute Length 	UP100-SL4	D4 ~ D20	159	422
	TiAlN	4 Flute, with Long Shank Length 	UP100-SH4	D3 ~ D20	160	422
	TiAlN	6 Flute, Standard Length 	UP100-S6	D6 ~ D20	161	422
	AlCrSiN	2 Flute, Stub Length 	UP210-SS2	D1 ~ D20	162	425
	AlCrSiN	2 Flute, Standard Length 	UP210-S2	D1 ~ D20	163	425
	AlCrSiN	2 Flute,with Long Flute Length 	UP210-SL2	D2 ~ D20	166	425
	AlCrSiN	2 Flute, with Long Shank Length 	UP210-SH2	D2 ~ D20	167	425
	AlCrSiN	3 Flute, Standard Length 	UP210-S3	D2 ~ D25	168	425
	AlCrSiN	4 Flute, Stub Length 	UP210-SS4	D1 ~ D20	169	426
	AlCrSiN	4 Flute, Standard Length 	UP210-S4	D1 ~ D20	170	426
	AlCrSiN	4 Flute,with Long Flute Length 	UP210-SL4	D1 ~ D20	173	426
	AlCrSiN	4 Flute, with Long Shank Length 	UP210-SH4	D2 ~ D20	175	426
	AlCrSiN	6 Flute, Standard Length 	UP210-S6	D6 ~ D20	176	426

⊙ most suitable ○ suitable

Workpiece Material											
P		M	K	N			S	H			
1 2 3 4	5 6	1 2 3	1 2 3	1 2 3	4	5	1 2 3	4	1	2	3 4
Carbon Steel, Alloy steel	Alloy Steel	Stainless Steel	Cast Iron	Aluminum Alloys	Copper Alloys	Graphite, Composite Materials	Heat Resistant Super Alloys	Titanium Alloys	Hardened Steel	Hardened Steel	Hardened Steel
<35HRC	<48HRC								45-55HRC	55-60HRC	>60HRC
⊙	○	○	⊙	○	○						
⊙	○	○	⊙	○	○						
⊙	○	○	⊙	○	○						
⊙	○	○	⊙	○	○						
⊙	○	○	⊙	○	○						
⊙	○	○	⊙	○	○						
⊙	○	○	⊙	○	○						
⊙	○	○	⊙	○	○						
⊙	○	○	⊙	○	○						
⊙	⊙	○	⊙								
⊙	⊙	○	⊙								
⊙	⊙	○	⊙								
⊙	⊙	○	⊙								
⊙	⊙	○	⊙								
⊙	⊙	○	⊙								
⊙	⊙	○	⊙								
⊙	⊙	○	⊙								
⊙	⊙	○	⊙								
⊙	⊙	○	⊙								
⊙	⊙	○	⊙								
⊙	⊙	○	⊙								





















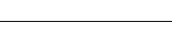















Endmills Index-Characteristic of Flute

No.of Flutes	Coat- ing	Description	Type	Diameter Range	Dimen- sion Page	Cutting Parame- ters Page
Square						
	AICrSiN	3 Flute, with Variable Helix		SP210-S3	D3 ~ D20	177 429
	AICrSiN	3 Flute, Variable Helix with Chamfer		SP210-C3	D6 ~ D16	178 429
	AICrSiN	4 Flute, Variable Helix with Chamfer		SP210-C4	D3 ~ D20	179 429
	AICrSiN	4 Flute, with Variable Helix		SP210-S4	D2 ~ D20	181 429
	AICrSiN	4 Flute, Variable Helix with Chamfer and with Reduced Neck		SP210-CN4	D3 ~ D20	182 429
	TiAlN	4 Flute Square End,with Roughing Geometry		UPR100-S4	D6 ~ D20	183 431
	AICrSiN	4 Flute Square End,with Roughing Geometry NEW		UPN210-S4	D6 ~ D20	184 433
	TiAlN	2 Flute ,Extended Neck-Square		UPM100-SN2	D0.8 ~ D2	185 435
	TiAlN	2 Flute, Standard Length		US200-S2	D0.5 ~ D20	186 437
	TiAlN	4 Flute, Stub Length		US200-SS4	D2 ~ D20	188 438
	TiAlN	4 Flute, Standard Length		US200-S4	D1 ~ D20	189 438
	TiAlN	4 Flute, with Long Shank Length		US200-SN4	D2 ~ D20	190 438
	TiAlN	4 Flute, Stub Length		US300-SS4	D1 ~ D4	191 439
	TiAlN	4 Flute, Standard Length		US300-S4	D1 ~ D12	192 439
	AICrSiN	4 Flute, Stub Length , Variable Helix with Chamfer		SS200-CS4	D2 ~ D12	193 440
	AICrSiN	4 Flute, Variable Helix with Chamfer		SS200-C4	D2 ~ D12	194 440
		2 Flute, Standard Length		UA100-S2	D1 ~ D20	195 441
		2 Flute,with Long Flute Length		UA100-SL2	D2 ~ D20	197 441
		2 Flute, with Long Shank Length		UA100-SH2	D2 ~ D20	198 441

⊙ most suitable ○ suitable















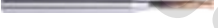



















Workpiece Material											
P		M	K	N			S	H			
1 2 3 4	5 6	1 2 3	1 2 3	1 2 3	4	5	1 2 3	4	1	2	3 4
Carbon Steel, Alloy steel	Alloy Steel	Stainless Steel	Cast Iron	Aluminum Alloys	Copper Alloys	Graphite, Composite Materials	Heat Resistant Super Alloys	Titanium Alloys	Hardened Steel	Hardened Steel	Hardened Steel
<35HRC	<48HRC								45-55HRC	55-60HRC	>60HRC
⊙	⊙	○	⊙								
⊙	⊙	○	⊙								
⊙	⊙	○	⊙								
⊙	⊙	○	⊙								
⊙	⊙	○	⊙								
⊙	⊙	○	⊙	○	○						
⊙	⊙	○	⊙	○	○						
⊙	○	○	⊙								
○	○	⊙	○				○	○			
○	○	⊙	○				○	○			
○	○	⊙	○				○	○			
○	○	⊙	○				○	○			
○	○	⊙	○				○	○			
○	○	⊙	○				○	○			
○	○	⊙	○				○	○			
○	○	⊙	○				○	○			
				⊙	⊙						
				⊙	⊙						
				⊙	⊙						

Endmills Index-Characteristic of Flute

No.of Flutes	Coat- ing	Description	Type	Diameter Range	Dimen- sion Page	Cutting Parame- ters Page
Square						
		3 Flute, Standard Length 	UA100-S3	D2 ~ D20	199	442
		3 Flute,with Long Flute Length 	UA100-SL3	D2 ~ D20	201	442
		3 Flute, with Long Shank Length 	UA100-SH3	D2 ~ D20	202	442
		2 Flute, Standard Length 	UA160-S2	D1 ~ D12	203	443
		3 Flute, Standard Length 	UA160-S3	D2 ~ D12	204	444
		4 Flute, Standard Length 	UA160-S4	D4 ~ D12	205	444
		3 Flute, Standard Length  NEW	SA100-S3	D3 ~ D12	206	445
	U-DIA	2 Flute, Standard Length 	SG200-S2	D0.4 ~ D12	207	449
	U-DIA	2 Flute, with Reduced Neck 	SG200-SN2	D1 ~ D12	210	449
	U-DIA	3 Flute, Standard Length 	SG200-S3	D1 ~ D12	208	449
	U-DIA	4 Flute, Standard Length 	SG200-S4	D2 ~ D12	209	449
	AlCrN	4 Flute , Standard Length Unequal Flute Spacing 	ST200-S4	D2 ~ D20	211	454
	TiAlN	2 Flute, Standard Length 	SH160-S2	D0.5 ~ D20	212	460
	TiAlN	4 Flute, Standard Length 	SH160-S4	D1 ~ D20	214	460
	TiAlN	4 Flute, with Long Shank Length 	SH160-SH4	D3 ~ D10	216	460
	TiAlN	6 Flute, Standard Length 	SH160-S6	D6 ~ D20	217	460
	TiAlC/SiN	4 Flute, Standard Length 	SH200-S4-H	D1 ~ D20	218	462
	TiAlC/SiN	4 Flute, with Long Shank Length 	SH200-SH4-H	D1 ~ D20	220	462
	TiAlC/SiN	4 Flute, With Reduced Neck 	SH200-SN4-H	D1 ~ D12	222	462

☉ most suitable ○ suitable

Endmills Index-Characteristic of Flute



























No.of Flutes	Coat- ing	Description	Type	Diameter Range	Dimen- sion Page	Cutting Param- eters Page
Square						
	TiAlC/SiN	4 Flute,with Long Flute Length 	SH200-SL4-H	D2 ~ D16	225	462
	TiAlC/SiN	2 Flute, Standard Length NEW 	SH300-S2-H	D1 ~ D12	226	463
	TiAlC/SiN	2 Flute, With Reduced Neck NEW 	SH300-SN2-H	D1 ~ D20	227	463
	TiAlC/SiN	4 Flute, Stub Length NEW 	SH300-SS4-H	D1 ~ D16	228	463
	TiAlC/SiN	4 Flute, Standard Length NEW 	SH300-S4-H	D1 ~ D20	230	463
	TiAlC/SiN	4 Flute, with Long Shank Length NEW 	SH300-SH4-H	D1 ~ D20	232	463
	TiAlC/SiN	4 Flute,with Long Flute Length NEW 	SH300-SL4-H	D1 ~ D20	234	463
	TiAlC/SiN	4 Flute, with Reduced Neck NEW 	SH300-SN4-H	D1 ~ D20	236	463
	TiAlC/SiN	6 Flute, Standard Length NEW 	SH300-S6-H	D6 ~ D20	240	464
	TiAlC/SiN	6 Flute, with Long Shank Length NEW 	SH300-SH6-H	D6 ~ D20	241	464
	TiAlC/SiN	6 Flute,with Long Flute Length NEW 	SH300-SL6-H	D6 ~ D20	242	464
	TiAlN	2 Flute ,Extended Neck-Square 	SHM100-SN2	D0.4 ~ D2	243	469
Cornor Radius						
	TiAlN	2 Flute, Corner Radius 	UP100-R2	D1 ~ D12	245	421
	TiAlN	2 Flute Corner Radius, with Long Shank Length 	UP100-RH2	D6 ~ D12	248	421
	TiAlN	4 Flute, Corner Radius 	UP100-R4	D2 ~ D16	249	422
	TiAlN	4 Flute Corner Radius, with Long Shank Length 	UP100-RH4	D6 ~ D16	252	422
	AlC/SiN	2 Flute, Corner Radius 	UP210-R2	D1 ~ D20	254	425
	AlC/SiN	2 Flute Corner Radius, with Long Shank Length 	UP210-RH2	D6 ~ D20	257	425

⊙ most suitable ○ suitable

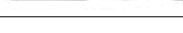
Endmills Index-Characteristic of Flute

No.of Flutes	Coat- ing	Description	Type	Diameter Range	Dimen- sion Page	Cutting Parame- ters Page
--------------	-----------	-------------	------	----------------	------------------	---------------------------

Cornor Radius

		4 Flute, Corner Radius 	UP210-R4	D1.5 ~ D20	259	426
		4 Flute Corner Radius, with Long Shank Length 	UP210-RH4	D6 ~ D20	262	426
		4 Flutes Corner Radius, with Variable Helix 	SP210-R4	D3 ~ D16	264	429
		2 Flute, Corner Radius 	US200-R2	D3 ~ D16	266	437
		3 Flute, Corner Radius 	US200-R3	D2 ~ D20	268	437
		4 Flute, Corner Radius 	US200-R4	D2 ~ D20	270	438
		2 Flute, Corner Radius 	UA100-R2	D1 ~ D20	272	441
		2 Flute Corner Radius, with Long Shank Length 	UA100-RH2	D6 ~ D20	275	441
		3 Flute, Corner Radius 	UA100-R3	D1 ~ D20	277	442
		3 Flute Corner Radius, with Long Shank Length 	UA100-RH3	D6 ~ D20	280	442
		2 Flute Corner Radius, with Reduced Neck 	SA300-RN2	D10 ~ D20	282	446
		3 Flute Corner Radius, with Reduced Neck 	SA300-RN3	D12 ~ D20	283	447
		2 Flute Corner Radius, with Reduced Neck 	SA310-RN2	D10 ~ D32	284	448
		3 Flute Corner Radius, with Reduced Neck 	SA310-RN3	D12 ~ D25	285	448
		2 Flute Corner Radius, Internal coolant With Reduced Neck 	SA360-RN2	D12 ~ D25	286	448
		2 Flute, Corner Radius 	SG200-R2	D2 ~ D12	287	449
		2 Flute Corner Radius, with Reduced Neck 	SG200-RN2	D2 ~ D6	288	449
		4 Flute, Corner Radius 	SG200-R4	D2 ~ D12	289	449
		4 Flute Corner Radius, with Reduced Neck 	SG200-RN4	D2 ~ D12	290	449

☉ most suitable ○ suitable

Workpiece Material											
P		M	K	N			S	H			
1 2 3 4	5 6	1 2 3	1 2 3	1 2 3	4	5	1 2 3	4	1	2	3 4
Carbon Steel, Alloy steel	Alloy Steel	Stainless Steel	Cast Iron	Aluminum Alloys	Copper Alloys	Graphite, Composite Materials	Heat Resistant Super Alloys	Titanium Alloys	Hardened Steel	Hardened Steel	Hardened Steel
<35HRC	<48HRC								45-55HRC	55-60HRC	>60HRC

	⊙	⊙	○	⊙							
	⊙	⊙	○	⊙							
	⊙	⊙	○	⊙							
	○	○	⊙	○			○	○			
	○	○	⊙	○			○	○			
	○	○	⊙	○			○	○			
				⊙	⊙						
				⊙	⊙						
				⊙	⊙						
				⊙	⊙						
				⊙	⊙						
				⊙	⊙						
				⊙	⊙						
				⊙	⊙						
				⊙	⊙						
				○	○	⊙					
				○	○	⊙					
				○	○	⊙					
				○	○	⊙					

Endmills Index-Characteristic of Flute

No.of Flutes	Coat- ing	Description	Type	Diameter Range	Dimen- sion Page	Cutting Parame- ters Page
--------------	-----------	-------------	------	----------------	------------------	---------------------------

Cornor Radius

		4 Flute , Corner Radius Unequal Flute Spacing 	SN200-R4	D6 ~ D18	291	452
		4 Flute , Corner Radius Unequal Flute Spacing 	ST200-R4	D6 ~ D20	292	454
		4 Flute , Corner Radius with Reduced Neck Unequal Flute Spacing 	ST200-RN4	D12 ~ D25	293	454
		5 Flute , Corner Radius with Reduced Neck Unequal Flute Spacing 	ST200-RN5	D16 ~ D25	294	455
		5 Flute , Long Flute length with Corner Radius Unequal Flute Spacing 	ST200-RL5	D16~D25	295	455
		4 Flute , Corner Radius with Reduced Neck Unequal Flute Spacing , Internal Coolant 	ST260-RN4	D12 ~ D25	296	457
		4 Flute , Corner Radius with Reduced Neck Unequal Flute Spacing , Internal Coolant 	ST300-RN4	D12 ~ D20	297	458
		5 Flute , Corner Radius with Reduced Neck Unequal Flute Spacing , Internal Coolant 	ST300-RN5	D16 ~ D25	298	459
		2 Flute, Corner Radius 	SH160-R2	D2 ~ D12	299	460
		4 Flute, Corner Radius 	SH160-R4	D3 ~ D12	301	460
		4 Flute Corner Radius, with Long Shank Length 	SH160-RH4	D6 ~ D10	303	460
		4 Flute, Corner Radius 	SH200-R4-H	D1 ~ D12	304	462
		4 Flute Corner Radius, with Long Shank Length 	SH200-RH4-H	D5 ~ D12	308	462
		4 Flute Corner Radius, with Reduced Neck 	SH200-RN4-H	D1.5 ~ D12	310	462
		2 Flute, Corner Radius 	SH300-R2-H	D1 ~ D12	311	463
		2 Flute Corner Radius, with Reduced Neck 	SH300-RN2-H	D1 ~ D6	313	463
		4 Flute, Corner Radius 	SH300-R4-H	D1 ~ D20	314	463
		4 Flute Corner Radius, with Long Shank Length 	SH300-RH4-H	D1 ~ D20	318	463
		4 Flute Corner Radius, with Reduced Neck 	SH300-RN4-H	D1 ~ D12	322	463

☉ most suitable ○ suitable

Workpiece Material											
P		M	K	N			S	H			
1 2 3 4	5 6	1 2 3	1 2 3	1 2 3	4	5	1 2 3	4	1	2	3 4
Carbon Steel, Alloy steel	Alloy Steel	Stainless Steel	Cast Iron	Aluminum Alloys	Copper Alloys	Graphite, Composite Materials	Heat Resistant Super Alloys	Titanium Alloys	Hardened Steel	Hardened Steel	Hardened Steel
<35HRC	<48HRC								45-55HRC	55-60HRC	>60HRC
	○	○	○				⊙	○			
	○	○	○					⊙			
	○	○	○					⊙			
	○	○	○					⊙			
	○	○	○					⊙			
	○	○	○					⊙			
	○	○	○					⊙			
	○	○	○					⊙			
									⊙		
									⊙		
									⊙		
	○	⊙							⊙	○	
	○	⊙							⊙	○	
	○	⊙							⊙	○	
		○							○	⊙	⊙
		○							○	⊙	⊙
		○							○	⊙	⊙
		○							○	⊙	⊙
		○							○	⊙	⊙

Endmills Index-Characteristic of Flute

No.of Flutes	Coat- ing	Description	Type	Diameter Range	Dimen- sion Page	Cutting Parame- ters Page
--------------	-----------	-------------	------	----------------	------------------	---------------------------

Cornor Radius























































	TiAlCrSiN	6 Flute, Corner Radius NEW 	SH300-R6-H	D6 ~ D20	330	464
	TiAlCrSiN	6 Flute Corner Radius, with Long Shank Length NEW 	SH300-RH6-H	D6 ~ D20	332	464
	TiAlCrSiN	6 Flute Corner Radius, with Long flute Length NEW 	SH300-RL6-H	D6 ~ D12	334	464
	TiAlCrSiN	4 Flute, Corner Radius NEW 	FH200-R4-H	D1 ~ D12	335	466
	TiAlCrSiN	4 Flute Corner Radius, with Reduced Neck NEW 	FH200-RN4-H	D8 ~ D12	337	466
	TiAlCrSiN	6 Flute, Corner Radius NEW 	FH200-R6-H	D6 ~ D20	339	467
	TiAlCrSiN	6 Flute Corner Radius, with Long Shank Length NEW 	FH200-RH6-H	D6 ~ D20	340	467
	TiAlCrSiN	6 Flute Corner Radius, with Reduced Neck NEW 	FH200-RN6-H	D6 ~ D20	341	467

Ballnose

	TiAlN	2 Flute, Ballnose 	UP100-B2	D0.8 ~ D20	342	424
	TiAlN	2 Flute Ballnose,with Long Shank Length 	UP100-BH2	D2 ~ D12	344	424
	TiAlN	4 Flute, Ballnose 	UP100-B4	D2 ~ D20	345	424
	AlCrSiN	2 Flute, Ballnose 	UP210-B2	D0.8 ~ D20	346	428
	AlCrSiN	2 Flute Ballnose,with Long Shank Length 	UP210-BH2	D2 ~ D20	348	428
	AlCrSiN	4 Flute, Ballnose 	UP210-B4	D2 ~ D20	349	428
	AlCrSiN	2 Flute, Ballnose 	SP210-B2	D1 ~ D12	351	431
	AlCrSiN	2 Flute Ballnose,with Long Shank Length 	SP210-BH2	D4 ~ D12	352	431
	TiAlN	2 Flute,Extended Neck- Ball Nose 	UPM100-BN2	D0.8 ~ D2	353	436
	TiAlN	2 Flute, Ballnose 	US200-B2	D1 ~ D20	354	438

⊙ most suitable ○ suitable





















Endmills Index-Characteristic of Flute

No.of Flutes	Coat- ing	Description	Type	Diameter Range	Dimen- sion Page	Cutting Parame- ters Page
Ballnose						
		4 Flute, Ballnose 	US200-B4	D1 ~ D20	355	438
		2 Flute, Ballnose 	UA100-B2	D1 ~ D16	356	443
		2 Flute Ballnose, Miniature Sizes with Reduced Neck 	SA300-BN2	D10 ~ D20	357	447
		2 Flute, Ballnose 	SG200-B2	D1 ~ D12	358	450
		2 Flute Ballnose, with Reduced Neck 	SG200-BN2	D1 ~ D12	359	450
		4 Flute , BallnoseUnequal Flute Spacing 	SN200-B4	D6 ~ D16	360	453
		4 Flute , BallnoseUnequal Flute Spacing 	ST200-B4	D6 ~ D16	361	456
		2 Flute, Ballnose 	SH160-B2	D0.5 ~ D16	362	461
		2 Flute Ballnose,with Long Shank Length 	SH160-BH2	D6 ~ D12	364	461
		4 Flute, Ballnose 	SH160-B4	D2 ~ D16	365	461
		2 Flute, Ballnose 	SH200-B2-H	D0.6 ~ D16	366	462
		2 Flute Ballnose,with Long Shank Length 	SH200-BH2-H	D4 ~ D16	368	462
		2 Flute Ballnose, with Reduced Neck 	SH200-BN2-H	D0.8 ~ D8	369	462
		2 Flute, Ballnose 	SH300-B2-H	D0.6 ~ D12	371	464
		2 Flute Ballnose,with Long Shank Length 	SH300-BH2-H	D0.6 ~ D12	373	464
		2 Flute Ballnose, with Reduced Neck 	SH300-BN2-H	D0.6 ~ D12	375	464
		4 Flute, Ballnose 	SH300-B4-H	D2 ~ D12	380	465
		4 Flute Ballnose,with Long Shank Length 	SH300-BH4-H	D2 ~ D12	381	465
		4 Flute Ballnose,with Reduced Neck 	SH300-BN4-H	D2 ~ D12	382	465

⊙ most suitable ○ suitable

Workpiece Material											
P		M	K	N			S	H			
1 2 3 4	5 6	1 2 3	1 2 3	1 2 3	4	5	1 2 3	4	1	2	3 4
Carbon Steel, Alloy steel	Alloy Steel	Stainless Steel	Cast Iron	Aluminum Alloys	Copper Alloys	Graphite, Composite Materials	Heat Resistant Super Alloys	Titanium Alloys	Hardened Steel	Hardened Steel	Hardened Steel
<35HRC	<48HRC								45-55HRC	55-60HRC	>60HRC
	○	○	⊙	○			○	○			
				⊙	⊙						
				⊙	⊙						
				○	○	⊙					
				○	○	⊙					
	○	○	○				⊙	○			
	○	○	○				○	⊙			
									⊙		
									⊙		
									⊙		
	○	⊙							⊙	○	
	○	⊙							⊙	○	
	○	⊙							⊙	○	
		○							○	⊙	⊙
		○							○	⊙	⊙
		○							○	⊙	⊙
		○							○	⊙	⊙
		○							○	⊙	⊙
		○							○	⊙	⊙
		○							○	⊙	⊙

















































Endmills Index-Characteristic of Flute



No. of Flutes	Coating	Description	Type	Diameter Range	Dimension Page	Cutting Parameters Page
Ballnose						
		2 Flute, Extended Neck- Ball Nose 	SHM100-BN2	D0.4 ~ D2	383	469
Small & Cavity Milling						
		2 Flute, Extended Neck-Square  	SPM200-SN2	D0.1-D6	388	470
		2 Flute, Extended Neck-Corner Radius  	SPM200-RN2	D0.2-D6	394	480
		2 Flute, Extended Neck-Ball Nose  	SPM200-BN2	D0.1-D6	408	502
Other						
		12 Flute, Burr-style Router 	SD200-KDA	D4 ~ D12	385	451
		2 Flute, Compression-style Cutter 	SD200-J2	D4 ~ D12	386	451

most suitable suitable

Workpiece Material											
P		M	K	N			S	H			
1 2 3 4	5 6	1 2 3	1 2 3	1 2 3	4	5	1 2 3	4	1	2	3 4
Carbon Steel, Alloy steel	Alloy Steel	Stainless Steel	Cast Iron	Aluminum Alloys	Copper Alloys	Graphite, Composite Materials	Heat Resistant Super Alloys	Titanium Alloys	Hardened Steel	Hardened Steel	Hardened Steel
<35HRC	<48HRC								45-55HRC	55-60HRC	>60HRC
									⊙	○	
	⊙	⊙	○	⊙	○	⊙		○	○	⊙	○
	⊙	⊙	○	⊙	○	⊙		○	○	⊙	○
	⊙	⊙	○	⊙	○	⊙		○	○	⊙	○
							⊙				
							⊙				

Endmills Index-Tool Series































































Workpiece Material	No. of Flutes	Endteeth Type	Coating	Description	Type	Diameter Range	Dimension Page	Cutting Parameters Page	
UP100									
Steels, Cast Iron			TiAlN	2 Flute, Stub Length 	UP100-SS2	D1 ~ D16	150	421	
			TiAlN	2 Flute, Standard Length 	UP100-S2	D1 ~ D20	151	421	
			TiAlN	2 Flute, with Long Flute Length 	UP100-SL2	D2 ~ D20	153	421	
			TiAlN	2 Flute, with Long Shank Length 	UP100-SH2	D1 ~ D20	154	421	
			TiAlN	3 Flute, Standard Length 	UP100-S3	D1 ~ D25	155	421	
			TiAlN	4 Flute, Standard Length 	UP100-S4	D1 ~ D20	156	422	
			TiAlN	4Flute, with Long Flute Length 	UP100-SL4	D4 ~ D20	159	422	
			TiAlN	4 Flute, with Long Shank Length 	UP100-SH4	D3 ~ D20	160	422	
			TiAlN	6 Flute, Standard Length 	UP100-S6	D6 ~ D20	161	422	
			TiAlN	2 Flute, Corner Radius 	UP100-R2	D1 ~ D12	245	421	
			TiAlN	2 Flute, with Long Shank Length 	UP100-RH2	D6 ~ D12	248	421	
			TiAlN	4 Flute, Corner Radius 	UP100-R4	D2 ~ D16	249	422	
			TiAlN	4 Flute Corner Radius, with Long Shank Length 	UP100-RH4	D6 ~ D16	252	422	
			TiAlN	2 Flute, Ballnose 	UP100-B2	D0.8 ~ D20	342	424	
			TiAlN	2 Flute, with Long Shank Length 	UP100-BH2	D2 ~ D12	344	424	
			TiAlN	4 Flute, Ballnose 	UP100-B4	D2 ~ D20	345	424	

 most suitable  suitable

Endmills Index-Tool Series

















































Workpiece Material	No. of Flutes	Endteeth Type	Coating	Description	Type	Diameter Range	Dimension Page	Cutting Parameters Page
--------------------	---------------	---------------	---------	-------------	------	----------------	----------------	-------------------------

UP210

Steels, Cast Iron				2 Flute, Stub Length 	UP210-SS2	D1 ~ D20	162	425
				2 Flute, Standard Length 	UP210-S2	D1 ~ D20	163	425
				2 Flute, with Long Flute Length 	UP210-SL2	D2 ~ D20	166	425
				2 Flute, with Long Shank Length 	UP210-SH2	D2 ~ D20	167	425
				3 Flute, Standard Length 	UP210-S3	D2 ~ D25	168	425
				4 Flute, Stub Length 	UP210-SS4	D1 ~ D20	169	426
				4 Flute, Standard Length 	UP210-S4	D1 ~ D20	170	426
				4 Flute, with Long Flute Length 	UP210-SL4	D1 ~ D20	173	426
				4 Flute, with Long Shank Length 	UP210-SH4	D2 ~ D20	175	426
				6 Flute, Standard Length 	UP210-S6	D6 ~ D20	176	426
				2 Flute, Corner Radius 	UP210-R2	D1 ~ D20	254	425
				2 Flute Corner Radius, with Long Shank Length 	UP210-RH2	D6 ~ D20	257	425
				4 Flute, Corner Radius 	UP210-R4	D1.5 ~ D20	259	426
				4 Flute Corner Radius, with Long Shank Length 	UP210-RH4	D6 ~ D20	262	426
				2 Flute, Ballnose 	UP210-B2	D0.8 ~ D20	346	428
				2 Flute Ballnose, with Long Shank Length 	UP210-BH2	D2 ~ D20	348	428
				4 Flute, Ballnose 	UP210-B4	D2 ~ D20	349	428

⊕ most suitable ○ suitable

Endmills Index-Tool Series





















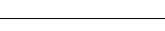















Workpiece Material	No. of Flutes	Endteeth Type	Coating	Description	Type	Diameter Range	Dimension Page	Cutting Parameters Page	
SP210									
Steels, Cast Iron				3 Flute, with Variable Helix 	SP210-S3	D3 ~ D20	177	429	
				3 Flute, Variable Helix with Chamfer 	SP210-C3	D6 ~ D16	178	429	
				4 Flute, Variable Helix with Chamfer 	SP210-C4	D3 ~ D20	179	429	
				4 Flute, with Variable Helix 	SP210-S4	D2 ~ D20	181	429	
				4 Flute, Variable Helix with Chamfer and with Reduced Neck 	SP210-CN4	D3 ~ D20	182	429	
				4 Flutes Corner Radius, with Variable Helix 	SP210-R4	D3 ~ D16	264	429	
				2 Flute, Ballnose 	SP210-B2	D1 ~ D12	351	431	
				2 Flute Ballnose, with Long Shank Length 	SP210-BH2	D4 ~ D12	352	431	
UPR100									
				4 Flute Square, with Roughing Geometry 	UPR100-S4	D6 ~ D20	183	431	
UPN210									
				4 Flute Square, with Roughing Geometry  NEW	UPN210-S4	D6 ~ D20	184	433	
UPM100									
				2 Flute, Extended Neck-Square 	UPM100-SN2	D0.8 ~ D2	185	435	
				2 Flute, Extended Neck-Ball Nose 	UPM100-BN2	D0.8 ~ D2	353	436	

⊙ most suitable ○ suitable

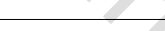
Workpiece Material											
P		M	K	N			S	H			
1 2 3 4	5 6	1 2 3	1 2 3	1 2 3	4	5	1 2 3	4	1	2	3 4
Carbon Steel, Alloy steel	Alloy Steel	Stainless Steel	Cast Iron	Aluminum Alloys	Copper Alloys	Graphite, Composite Materials	Heat Resistant Super Alloys	Titanium Alloys	Hardened Steel	Hardened Steel	Hardened Steel
<35HRC	<48HRC								45-55HRC	55-60HRC	>60HRC

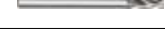
	⊙	⊙	○	⊙							
	⊙	⊙	○	⊙							
	⊙	⊙	○	⊙							
	⊙	⊙	○	⊙							
	⊙	⊙	○	⊙							
	⊙	⊙	○	⊙							
	⊙	⊙	○	⊙							
	⊙	⊙	○	⊙							
					○	○					
	⊙	⊙	○	⊙	○	○					
	⊙	○	○	⊙							
	⊙	○	○	⊙							

Endmills Index-Tool Series

































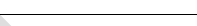











Workpiece Material	No. of Flutes	Endteeth Type	Coating	Description	Type	Diameter Range	Dimension Page	Cutting Parameters Page	
US200									
Stainless Steel			TiAlN	2 Flute, Standard Length 	US200-S2	D0.5 ~ D20	186	437	
			TiAlN	4 Flute, Stub Length 	US200-SS4	D2 ~ D20	188	438	
			TiAlN	4 Flute, Standard Length 	US200-S4	D1 ~ D20	189	438	
			TiAlN	4 Flute, with Reduced Neck 	US200-SN4	D2 ~ D20	190	438	
			TiAlN	2 Flute, Corner Radius 	US200-R2	D3 ~ D16	266	437	
			TiAlN	3 Flute, Corner Radius 	US200-R3	D2 ~ D20	268	437	
			TiAlN	4 Flute, Corner Radius 	US200-R4	D2 ~ D20	270	438	
			TiAlN	2 Flute, Ballnose 	US200-B2	D1 ~ D20	354	438	
			TiAlN	4 Flute, Ballnose 	US200-B4	D1 ~ D20	355	438	
	US300								
			TiAlN	4 Flute, Stub Length 	US300-SS4	D1 ~ D4	191	439	
			TiAlN	4 Flute, Standard Length 	US300-S4	D1 ~ D12	192	439	
SS200									
			AlCrSiN	4 Flute, Stub Length , Variable Helix with Chamfer 	SS200-CS4	D2 ~ D12	193	440	
			AlCrSiN	4 Flute, Variable Helix with Chamfer 	SS200-C4	D2 ~ D12	194	440	

⊙ most suitable ○ suitable

Workpiece Material											
P		M	K	N			S		H		
1 2 3 4	5 6	1 2 3	1 2 3	1 2 3	4	5	1 2 3	4	1	2	3 4
Carbon Steel, Alloy steel	Alloy Steel	Stainless Steel	Cast Iron	Aluminum Alloys	Copper Alloys	Graphite, Composite Materials	Heat Resistant Super Alloys	Titanium Alloys	Hardened Steel	Hardened Steel	Hardened Steel
<35HRC	<48HRC								45-55HRC	55-60HRC	>60HRC

	○	○	⊙	○				○	○			
	○	○	⊙	○				○	○			
	○	○	⊙	○				○	○			
	○	○	⊙	○				○	○			
	○	○	⊙	○				○	○			
	○	○	⊙	○				○	○			
	○	○	⊙	○				○	○			
	○	○	⊙	○				○	○			
	○	○	⊙	○				○	○			
	○	○	⊙	○				○	○			
	○	○	⊙	○				○	○			
	○	○	⊙	○				○	○			
	○	○	⊙	○				○	○			
	○	○	⊙	○				○	○			
	○	○	⊙	○				○	○			
	○	○	⊙	○				○	○			

Endmills Index-Tool Series

Workpiece Material	No. of Flutes	Endteeth Type	Coating	Description	Type	Diameter Range	Dimension Page	Cutting Parameters Page
UA100								
Stainless Steel				2 Flute, Standard Length 	UA100-S2	D1 ~ D20	195	441
				2 Flute, with Long Flute Length 	UA100-SL2	D2 ~ D20	197	441
				2 4 Flute, with Reduced Neck 	UA100-SH2	D2 ~ D20	198	441
				3 Flute, Standard Length 	UA100-S3	D2 ~ D20	199	442
				3 Flute, with Long Flute Length 	UA100-SL3	D2 ~ D20	201	442
				3 Flute, with Long Shank Length 	UA100-SH3	D2 ~ D20	202	442
				2 Flute, Corner Radius 	UA100-R2	D1 ~ D20	272	441
				2 Flute Corner Radius, with Long Shank Length 	UA100-RH2	D6 ~ D20	275	441
				3 Flute, Corner Radius 	UA100-R3	D1 ~ D20	277	442
				3 Flute Corner Radius, with Long Shank Length 	UA100-RH3	D6 ~ D20	280	442
				2 Flute, Ballnose 	UA100-B2	D1 ~ D16	356	443
UA160								
				2 Flute, Standard Length 	UA160-S2	D1 ~ D12	203	443
				3 Flute, Standard Length 	UA160-S3	D2 ~ D12	204	444
				4Flute, Standard Length 	UA160-S4	D4 ~ D12	205	444
SA100								
				3Flute, Standard Length  	SA100-S3	D3 ~ D12	206	445

⊙ most suitable ○ suitable

























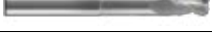

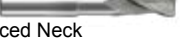



















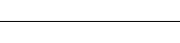









Workpiece Material											
P		M	K	N			S	H			
1 2 3 4	5 6	1 2 3	1 2 3	1 2 3	4	5	1 2 3	4	1	2	3 4
Carbon Steel, Alloy steel	Alloy Steel	Stainless Steel	Cast Iron	Aluminum Alloys	Copper Alloys	Graphite, Composite Materials	Heat Resistant Super Alloys	Titanium Alloys	Hardened Steel	Hardened Steel	Hardened Steel
<35HRC	<48HRC								45-55HRC	55-60HRC	>60HRC

					⊙	⊙					
					⊙	⊙					
					⊙	⊙					
					⊙	⊙					
					⊙	⊙					
					⊙	⊙					
					⊙	⊙					
					⊙	⊙					
					⊙	⊙					
					⊙	⊙					
					⊙	⊙					

					⊙	⊙					
					⊙	⊙					
					⊙	⊙					

					⊙	⊙					
--	--	--	--	--	---	---	--	--	--	--	--

Endmills Index-Tool Series





































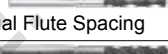











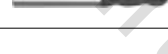

Workpiece Material	No. of Flutes	Endteeth Type	Coating	Description	Type	Diameter Range	Dimension Page	Cutting Parameters Page
Aluminum Alloys	SA300							
				2 Flute Corner Radius, with Reduced Neck 	SA300-RN2	D10 ~ D20	282	446
				3 Flute Corner Radius, with Reduced Neck 	SA300-RN3	D12 ~ D20	283	447
				2 Flute Ballnose, with Reduced Neck 	SA300-BN2	D10 ~ D20	357	447
	SA310							
				2 Flute Corner Radius, with Reduced Neck 	SA310-RN2	D10 ~ D32	284	448
				3 Flute Corner Radius, with Reduced Neck 	SA310-RN3	D12 ~ D25	285	448
	SA360							
				2 Flute Corner Radius, Internal coolant With Reduced Neck 	SA360-RN2	D12 ~ D25	286	448
	Graphite	SG200						
				2 Flute, Standard Length 	SG200-S2	D0.4 ~ D12	207	449
				2 Flute, With Reduced Neck 	SG200-SN2	D1 ~ D12	210	449
				3 Flute, Standard Length 	SG200-S3	D1 ~ D12	208	449
				4 Flute, Standard Length 	SG200-S4	D2 ~ D12	209	449
				2 Flute, Corner Radius 	SG200-R2	D2 ~ D12	287	449
				2 Flute Corner Radius, with Reduced Neck 	SG200-RN2	D2 ~ D6	288	449
				4 Flute, Corner Radius 	SG200-R4	D2 ~ D12	289	449
				4 Flute Corner Radius, with Reduced Neck 	SG200-RN4	D2 ~ D12	290	449
				2 Flute, Ballnose 	SG200-B2	D1 ~ D12	358	450
			2 Flute, Ballnose, With Reduced Neck 	SG200-BN2	D1 ~ D12	359	450	

⊙ most suitable ○ suitable

Workpiece Material											
P		M	K	N			S	H			
1 2 3 4	5 6	1 2 3	1 2 3	1 2 3	4	5	1 2 3	4	1	2	3 4
Carbon Steel, Alloy steel	Alloy Steel	Stainless Steel	Cast Iron	Aluminum Alloys	Copper Alloys	Graphite, Composite Materials	Heat Resistant Super Alloys	Titanium Alloys	Hardened Steel	Hardened Steel	Hardened Steel
<35HRC	<48HRC								45-55HRC	55-60HRC	>60HRC

					⊙	⊙					
					⊙	⊙					
					⊙	⊙					
					⊙	⊙					
					⊙	⊙					
					⊙	⊙					
					⊙	⊙					
					⊙	⊙					
					⊙	⊙	⊙				
					⊙	⊙	⊙				
					⊙	⊙	⊙				
					⊙	⊙	⊙				
					⊙	⊙	⊙				
					⊙	⊙	⊙				
					⊙	⊙	⊙				
					⊙	⊙	⊙				
					⊙	⊙	⊙				
					⊙	⊙	⊙				
					⊙	⊙	⊙				
					⊙	⊙	⊙				
					⊙	⊙	⊙				

































































Endmills Index-Tool Series

Workpiece Material	No. of Flutes	Endteeth Type	Coating	Description	Type	Diameter Range	Dimension Page	Cutting Parameters Page	
SD200									
Composite Material				12 Flute, Burr-style Router 	SD200-KDA	D4 ~ D12	385	451	
				2 Flute, Compression-style Cutter 	SD200-J2	D4 ~ D12	386	451	
SN200									
Heat Resistant Super Alloys				4 Flute, Corner Radius Unequal Flute Spacing 	SN200-R4	D6 ~ D18	291	452	
				4 Flute, Ballnose Unequal Flute Spacing 	SN200-B4	D6 ~ D16	360	453	
ST200									
Titanium Alloy				4 Flute, Standard Length Unequal Flute Spacing 	ST200-S4	D2 ~ D20	211	454	
				4 Flute, Corner Radius Unequal Flute Spacing 	ST200-R4	D6 ~ D16	292	454	
				4 Flute, Corner Radius with Reduced Neck Unequal Flute Spacing 	ST200-RN4	D12 ~ D25	293	454	
				5 Flute, Corner Radius with Reduced Neck Unequal Flute Spacing 	ST200-RN5	D16~D25	294	455	
				5 Flute, Long Flute length with Corner Radius Unequal Flute Spacing 	ST200-RL5	D16~D25	295	455	
				4 Flute, Ballnose Unequal Flute Spacing 	ST200-B4	D6 ~ D16	361	456	
ST260									
				4 Flute, Corner Radius with Reduced Neck Unequal Flute Spacing, Internal Coolant 	ST260-RN4	D12 ~ D25	296	457	
ST300									
				4 Flute, Corner Radius with Reduced Neck Unequal Flute Spacing, Internal Coolant 	ST300-RN4	D12 ~ D20	297	458	
				5 Flute, Corner Radius with Reduced Neck Unequal Flute Spacing, Internal Coolant 	ST300-RN5	D16 ~ D25	298	459	

⊙ most suitable ○ suitable

Workpiece Material											
P		M	K	N			S		H		
1 2 3 4	5 6	1 2 3	1 2 3	1 2 3	4	5	1 2 3	4	1	2	3 4
Carbon Steel, Alloy steel	Alloy Steel	Stainless Steel	Cast Iron	Aluminum Alloys	Copper Alloys	Graphite, Composite Materials	Heat Resistant Super Alloys	Titanium Alloys	Hardened Steel	Hardened Steel	Hardened Steel
<35HRC	<48HRC								45-55HRC	55-60HRC	>60HRC
							⊙				
							⊙				
	⊙	⊙	⊙					⊙	⊙		
	⊙	⊙	⊙					⊙	⊙		
	⊙	⊙	⊙								
	⊙	⊙	⊙					⊙			
	⊙	⊙	⊙					⊙			
	⊙	⊙	⊙					⊙			
	⊙	⊙	⊙					⊙			
	⊙	⊙	⊙					⊙			
	⊙	⊙	⊙					⊙			
	⊙	⊙	⊙					⊙			

Endmills Index-Tool Series

Workpiece Material	No. of Flutes	End-Teeth Type	Coating	Description	Type	Diameter Range	Dimension Page	Cutting Parameters Page	
SH160									
Hardened Steel				2 Flute, Standard Length 	SH160-S2	D0.5 ~ D20	212	460	
				4 Flute, Standard Length 	SH160-S4	D1 ~ D20	214	460	
				4 4 Flute, with Long Shank Length 	SH160-SH4	D3 ~ D10	216	460	
				6 Flute, Standard Length 	SH160-S6	D6 ~ D20	217	460	
				2 Flute, Corner Radius 	SH160-R2	D2 ~ D12	299	460	
				4 Flute, Corner Radius 	SH160-R4	D3 ~ D12	301	460	
				4 Flute Corner Radius, with Long Shank Length 	SH160-RH4	D6 ~ D10	303	460	
				2 Flute, Ballnose 	SH160-B2	D0.5 ~ D16	362	461	
				2 Flute Ballnose, with Long Shank length 	SH160-BH2	D6 ~ D12	364	461	
				4 Flute, Ballnose 	SH160-B4	D2 ~ D16	365	461	
SH200-H									
Hardened Steel				4 Flute, Standard Length 	SH200-S4-H	D1 ~ D20	218	462	
				4 Flute, with Long Shank Length 	SH200-SH4-H	D1 ~ D20	220	462	
				4 Flute, with Reduced Neck 	SH200-SN4-H	D1 ~ D12	222	462	
				4 Flute, with Long Flute Length 	SH200-SL4-H	D2 ~ D16	225	462	
				4 Flute, Corner Radius 	SH200-R4-H	D1 ~ D12	304	462	
				4 Flute Corner Radius, with Long Shank Length 	SH200-RH4-H	D5 ~ D12	308	462	



















⊙ most suitable ○ suitable

Workpiece Material											
P		M	K	N			S	H			
1 2 3 4	5 6	1 2 3	1 2 3	1 2 3	4	5	1 2 3	4	1	2	3 4
Carbon Steel, Alloy steel	Alloy Steel	Stainless Steel	Cast Iron	Aluminum Alloys	Copper Alloys	Graphite, Composite Materials	Heat Resistant Super Alloys	Titanium Alloys	Hardened Steel	Hardened Steel	Hardened Steel
<35HRC	<48HRC								45-55HRC	55-60HRC	>60HRC

									⊙		
									⊙		
									⊙		
									⊙		
									⊙		
									⊙		
									⊙		
									⊙		
									⊙		
									⊙		
									⊙		

	○	⊙							⊙	○	
	○	⊙							⊙	○	
	○	⊙							⊙	○	
	○	⊙							⊙	○	
	○	⊙							⊙	○	
	○	⊙							⊙	○	
	○	⊙							⊙	○	

Endmills Index-Tool Series

Workpiece Material	No. of Flutes	Endteeth Type	Coating	Description	Type	Diameter Range	Dimension Page	Cutting Parameters Page	
SH200-H									
Hardened Steel	4	Corner-R	TiAlC/SiN	4 Flute Corner Radius with Reduced Neck 	SH200-RN4-H	D1.5 ~ D12	310	462	
	2	Ballnose	TiAlC/SiN	2 Flute, Ballnose 	SH200-B2-H	D0.6 ~ D16	366	462	
	2	Ballnose	TiAlC/SiN	2 Flute Ballnose, with Long Shank Length 	SH200-BH2-H	D4 ~ D16	368	462	
	2	Ballnose	TiAlC/SiN	2 Flute Ballnose, with Reduced Neck 	SH200-BN2-H	D0.8 ~ D8	369	462	
SH300-H									
Hardened Steel	2	Square	TiAlC/SiN	2 Flute, Standard Length  NEW	SH300-S2-H	D1 ~ D12	226	463	
	2	Square	TiAlC/SiN	2 Flute, with Reduced Neck  NEW	SH300-SN2-H	D1 ~ D20	227	463	
	4	Square	TiAlC/SiN	4 Flute, Stub Length  NEW	SH300-SS4-H	D1 ~ D16	228	463	
	4	Square	TiAlC/SiN	4 Flute, Standard Length  NEW	SH300-S4-H	D1 ~ D20	230	463	
	4	Square	TiAlC/SiN	4 Flute, with Long Shank Length  NEW	SH300-SH4-H	D1 ~ D20	232	463	
	4	Square	TiAlC/SiN	4 Flute, with Long Flute Length  NEW	SH300-SL4-H	D1 ~ D20	234	463	
	4	Square	TiAlC/SiN	4 Flute, with Reduced Neck  NEW	SH300-SN4-H	D1 ~ D20	236	463	
	6	Square	TiAlC/SiN	6 Flute, Standard Length  NEW	SH300-S6-H	D6 ~ D20	240	464	
	6	Square	TiAlC/SiN	6 Flute, with Long Shank Length  NEW	SH300-SH6-H	D6 ~ D20	241	464	
	6	Square	TiAlC/SiN	6 Flute, with Long Flute Length  NEW	SH300-SL6-H	D6 ~ D20	242	464	
	2	Corner-R	TiAlC/SiN	2 Flute, Corner Radius  NEW	SH300-R2-H	D1 ~ D12	311	463	
	2	Corner-R	TiAlC/SiN	2 Flute Corner Radius, with Reduced Neck  NEW	SH300-RN2-H	D1 ~ D6	313	463	
	4	Corner-R	TiAlC/SiN	4 Flute, Corner Radius  NEW	SH300-R4-H	D1 ~ D20	314	463	
	4	Corner-R	TiAlC/SiN	4 Flute Corner Radius, with Long Shank Length  NEW	SH300-RH4-H	D1 ~ D20	318	463	

⊙ most suitable ○ suitable

Workpiece Material											
P		M	K	N			S	H			
1 2 3 4	5 6	1 2 3	1 2 3	1 2 3	4	5	1 2 3	4	1	2	3 4
Carbon Steel, Alloy steel	Alloy Steel	Stainless Steel	Cast Iron	Aluminum Alloys	Copper Alloys	Graphite, Composite Materials	Heat Resistant Super Alloys	Titanium Alloys	Hardened Steel	Hardened Steel	Hardened Steel
<35HRC	<48HRC								45-55HRC	55-60HRC	>60HRC

	○	⊙							⊙	○	
	○	⊙							⊙	○	
	○	⊙							⊙	○	
	○	⊙							⊙	○	

		○							○	⊙	⊙
		○							○	⊙	⊙
		○							○	⊙	⊙
		○							○	⊙	⊙
		○							○	⊙	⊙
		○							○	⊙	⊙
		○							○	⊙	⊙
		○							○	⊙	⊙
		○							○	⊙	⊙
		○							○	⊙	⊙
		○							○	⊙	⊙
		○							○	⊙	⊙
		○							○	⊙	⊙
		○							○	⊙	⊙
		○							○	⊙	⊙
		○							○	⊙	⊙
		○							○	⊙	⊙
		○							○	⊙	⊙
		○							○	⊙	⊙
		○							○	⊙	⊙
		○							○	⊙	⊙
		○							○	⊙	⊙
		○							○	⊙	⊙

Endmills Index-Tool Series

Workpiece Material	No. of Flutes	Endteeth Type	Coating	Description	Type	Diameter Range	Dimension Page	Cutting Parameters Page
--------------------	---------------	---------------	---------	-------------	------	----------------	----------------	-------------------------

SH300-H

Hardened Steel				4 Flute Corner Radius, with Reduced Neck NEW		SH300-RN4-H	D1 ~ D12	322	463
				6 Flute, Corner Radius NEW		SH300-R6-H	D6 ~ D20	330	464
				6 Flute Corner Radius, with Long Shank Length NEW		SH300-RH6-H	D6 ~ D20	332	464
				6 Flute Corner Radius, with Long Flute Length NEW		SH300-RL6-H	D6 ~ D12	334	464
				2 Flute, Ballnose NEW		SH300-B2-H	D0.6 ~ D12	371	464
				2 Flute Ballnose, with Long Shank Length NEW		SH300-BH2-H	D0.6 ~ D12	373	464
				2 Flute Ballnose, with Reduced Neck NEW		SH300-BN2-H	D0.6 ~ D12	375	464
				4 Flute, Ballnose NEW		SH300-B4-H	D2 ~ D12	380	465
				4 Flute Ballnose, with Long Shank Length NEW		SH300-BH4-H	D2 ~ D12	381	465
				4 Flute Ballnose, with Reduced Neck NEW		SH300-BN4-H	D2 ~ D12	382	465

FH200-H

				4 Flute, Corner Radius NEW		FH200-R4-H	D1 ~ D12	335	466
				4 Flute Corner Radius, with Reduced Neck NEW		FH200-RN4-H	D8 ~ D12	337	466
				6 Flute, Corner Radius NEW		FH200-R6-H	D6 ~ D20	339	467
				6 Flute Corner Radius, with Long Shank Length NEW		FH200-RH6-H	D6 ~ D20	340	467
				6 Flute Corner Radius, with Reduced Neck NEW		FH200-RN6-H	D6 ~ D20	341	467

SHM100

				2 Flute, Extended Neck-Square		SHM100-SN2	D0.4 ~ D2	243	469
				2 Flute, Extended Neck-Ball Nose		SHM100-BN2	D0.4 ~ D2	383	469

⦿ most suitable ○ suitable















Workpiece Material											
P		M	K	N			S	H			
1 2 3 4	5 6	1 2 3	1 2 3	1 2 3	4	5	1 2 3	4	1	2	3 4
Carbon Steel, Alloy steel	Alloy Steel	Stainless Steel	Cast Iron	Aluminum Alloys	Copper Alloys	Graphite, Composite Materials	Heat Resistant Super Alloys	Titanium Alloys	Hardened Steel	Hardened Steel	Hardened Steel
<35HRC	<48HRC								45-55HRC	55-60HRC	>60HRC

		○							○	⊙	⊙
		○							○	⊙	⊙
		○							○	⊙	⊙
		○							○	⊙	⊙
		○							○	⊙	⊙
		○							○	⊙	⊙
		○							○	⊙	⊙
		○							○	⊙	⊙
		○							○	⊙	⊙
		○							○	⊙	⊙
		○							○	⊙	⊙

		⊙							⊙	⊙	⊙
		⊙							⊙	⊙	⊙
		⊙							⊙	⊙	⊙
		⊙							⊙	⊙	⊙
		⊙							⊙	⊙	⊙

									⊙	○	
									⊙	○	

Endmills Index-Tool Series

Work-piece Material	No. of Flutes	End-teeth Type	Coating	Description	Type	Diameter Range	Dimension Page	Cutting Parameters Page	
SPM200									
Steels Cast Iron Copper Alloys High Hardened Material				2 Flute, Extended Neck-Square 		SPM200-SN2	D0.1-D6	388	470
				2 Flute, Extended Neck-Corner Radius 		SPM200-RN2	D0.2-D6	394	480
				2 Flute, Extended Neck- Ball Nose 		SPM200-BN2	D0.1-D6	408	502

most suitable suitable

Workpiece Material											
P			M	K	N			S	H		
1 2 3 4	5 6	1 2 3	1 2 3	1 2 3	4	5	1 2 3	4	1	2	3 4
Carbon Steel, Alloy steel	Alloy Steel	Stainless Steel	Cast Iron	Aluminum Alloys	Copper Alloys	Graphite, Composite Materials	Heat Resistant Super Alloys	Titanium Alloys	Hardened Steel	Hardened Steel	Hardened Steel
<35HRC	<48HRC								45-55HRC	55-60HRC	>60HRC

	⊙	⊙	○	⊙	○	⊙		○	○	⊙	○	
	⊙	⊙	○	⊙	○	⊙		○	○	⊙	○	
	⊙	⊙	○	⊙	○	⊙		○	○	⊙	○	

UP100-SS2

2 Flute, Stub Length

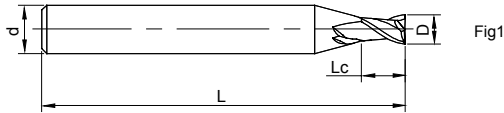

Fig1

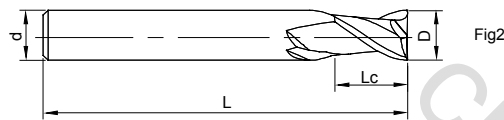

Fig2



See page 97 for guidelines to icons

Ordering Code	D	Lc	L	d	Figure No.	Stock
UP100-SS2-01002	1	2	50	4	1	●
UP100-SS2-02003	2	3	50	4	1	○
UP100-SS2-03005	3	5	50	4	1	○
UP100-SS2-04006	4	6	50	4	2	○
UP100-SS2-05008	5	8	50	6	1	○
UP100-SS2-06009	6	9	50	6	2	○
UP100-SS2-07010	7	10	60	8	1	○
UP100-SS2-08012	8	12	60	8	2	○
UP100-SS2-10015	10	15	75	10	2	○
UP100-SS2-12018	12	18	75	12	2	○
UP100-SS2-16024	16	24	100	16	2	○

● Stock ○ Available upon Order

D	Tol
D 12	0 -0.02
D > 12	0 -0.03

unit (mm)

Workpiece Material

P		M	K	N		
1234	5	123	123	123	4	5
Carbon Steel, Alloy Steel (<35 HRC)	Alloy Steel, Tool Steel (<48HRC)	Stainless Steel	Cast Iron	Aluminium Alloys	Copper Alloys	Graphite
⊙	○	○	⊙	○	○	

⊙ Most Suitable ○ Suitable

Cutting Parameters ※ P421

UP100-S2

2 Flute, Standard Length

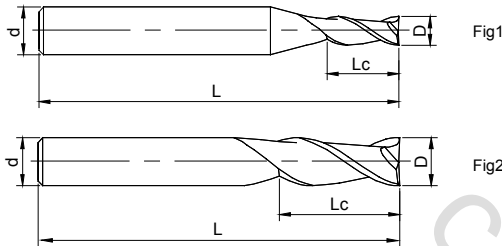

See page 97 for guidelines to icons

Ordering Code	D	Lc	L	d	Figure No.	Stock
UP100-S2-01003	1	3	50	4	1	●
UP100-S2-01505	1.5	5	50	4	1	○
UP100-S2-02006	2	6	50	4	1	●
UP100-S2-02506	2.5	6	50	4	1	○
UP100-S2-03009	3	9	50	4	1	○
UP100-S2-63009	3	9	50	6	1	○
UP100-S2-03509	3.5	9	50	4	1	●
UP100-S2-63509	3.5	9	50	6	1	●
UP100-S2-04010	4	10	50	4	2	●
UP100-S2-04011	4	11	50	4	2	○
UP100-S2-64011	4	11	50	6	1	●
UP100-S2-04511	4.5	11	50	6	1	○
UP100-S2-05013	5	13	50	6	1	○
UP100-S2-06015	6	15	50	6	2	●
UP100-S2-06016	6	16	50	6	2	●
UP100-S2-06516	6.5	16	60	8	1	○
UP100-S2-07020	7	20	60	8	1	●

● Stock ○ Available upon Order

D	Tol
D 12	0 -0.02
D > 12	0 -0.03

unit (mm)

Workpiece Material						
P		M	K	N		
1234	5	123	123	123	4	5
Carbon Steel, Alloy Steel (<35 HRC)	Alloy Steel, Tool Steel (<48HRC)	Stainless Steel	Cast Iron	Aluminium Alloys	Copper Alloys	Graphite
⊙	○	○	⊙	○	○	

● Most Suitable ○ Suitable

Cutting Parameters ※ P421

UP100-S2

2 With Long Flute Length

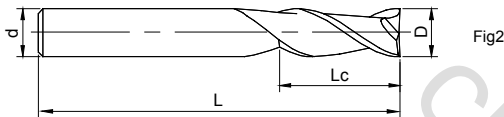
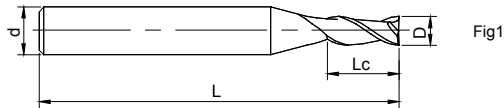

See page 97 for guidelines to icons

» continue

Ordering Code	D	Lc	L	d	Figure No.	Stock
UP100-S2-07520	7.5	20	60	8	1	○
UP100-S2-08020	8	20	60	8	2	●
UP100-S2-08523	8.5	23	75	10	1	○
UP100-S2-09023	9	23	75	10	1	●
UP100-S2-09525	9.5	25	75	10	1	○
UP100-S2-10025	10	25	75	10	2	○
UP100-S2-10526	10.5	26	75	12	1	○
UP100-S2-11028	11	28	75	12	1	●
UP100-S2-12030	12	30	75	12	2	●
UP100-S2-14034	14	34	100	14	2	○
UP100-S2-15036	15	36	90	16	1	○
UP100-S2-16036	16	36	100	16	2	○
UP210-S2-17040	17	40	100	20	1	○
UP100-S2-18040	18	40	100	18	2	○
UP100-S2-19040	19	40	100	20	1	○
UP100-S2-20045	20	45	100	20	2	○

● Stock ○ Available upon Order

D	Tol
D 12	0 -0.02
D > 12	0 -0.03

unit(mm)

Workpiece Material						
P		M	K	N		
1234	5	123	123	123	4	5
Carbon Steel, Alloy Steel(<35 HRC)	Alloy Steel, Tool Steel(<48HRC)	Stainless Steel	Cast Iron	Aluminium Alloys	Copper Alloys	Graphite
⊙	○	○	⊙	○	○	

⊙ Most Suitable ○ Suitable

Cutting Parameters ※ P421

UP100-SL2

2 Flute, With Long Flute Length

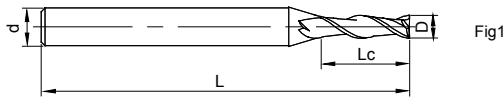

Fig1

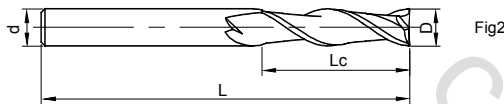

Fig2



See page 97 for guidelines to

Ordering Code	D	Lc	L	d	Figure No.	Stock
UP100-SL2-02015	2	15	75	4	1	○
UP100-SL2-03025	3	25	75	4	1	○
UP100-SL2-04030	4	30	75	4	2	○
UP100-SL2-05030	5	30	75	6	1	○
UP100-SL2-06035	6	35	75	6	2	○
UP100-SL2-08040	8	40	100	8	2	●
UP100-SL2-10045	10	45	100	10	2	○
UP100-SL2-12050	12	50	100	12	2	○
UP100-SL2-14055	14	55	100	14	2	○
UP100-SL2-16050	16	50	150	16	2	○
UP100-SL2-16060	16	60	150	16	2	○
UP100-SL2-18065	18	65	150	18	2	○
UP100-SL2-20070	20	70	150	20	2	○

● Stock ○ Available upon Order

D	Tol
D 12	$\begin{matrix} 0 \\ -0.02 \end{matrix}$
D > 12	$\begin{matrix} 0 \\ -0.03 \end{matrix}$

unit mm)

Workpiece Material						
P		M	K	N		
1234	5	123	123	123	4	5
Carbon Steel, Alloy Steel (<35 HRC)	Alloy Steel, Tool Steel (<48HRC)	Stainless Steel	Cast Iron	Aluminium Alloys	Copper Alloys	Graphite
⊙	○	○	⊙	○	○	

⊙ Most Suitable ○ Suitable

Cutting Parameters ※ P421

UP100-SH2

2 Flute, with Long Shank Length

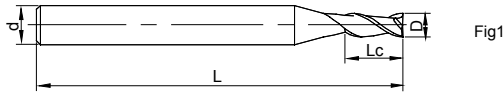

Fig1

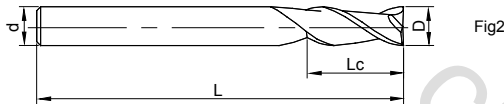

Fig2



See page 97 for guidelines to

Ordering Code	D	Lc	L	d	Figure No.	Stock
UP100-SH2-02006	2	6	75	4	1	○
UP100-SH2-03009	3	9	75	4	1	○
UP100-SH2-63012	3	12	75	6	1	○
UP100-SH2-04011	4	11	75	4	2	○
UP100-SH2-05020	5	20	75	6	1	○
UP100-SH2-06016	6	16	100	6	2	○
UP100-SH2-06020	6	20	100	6	2	○
UP100-SH2-08020	8	20	75	8	2	○
UP100-SH2-08025	8	25	100	8	2	●
UP100-SH2-10030	10	30	100	10	2	○
UP100-SH2-12035	12	35	100	12	2	○
UP100-SH2-16036	16	36	150	16	2	○
UP100-SH2-20045	20	45	150	20	2	○

●Stock ○Available upon Order

D	Tol
D 12	0 -0.02
D > 12	0 -0.03

unit (mm)

Workpiece Material

P		M	K	N		
1234	5	123	123	123	4	5
Carbon Steel, Alloy Steel (<35 HRC)	Alloy Steel, Tool Steel (<48HRC)	Stainless Steel	Cast Iron	Aluminium Alloys	Copper Alloys	Graphite
⊙	○	○	⊙	○	○	

⊙ Most Suitable ○ Suitable

Cutting Parameters ※ P421

UP100-S3

3 Flute, Standard Length

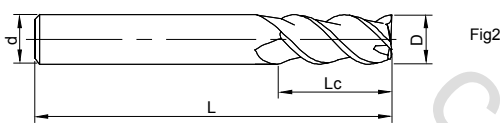
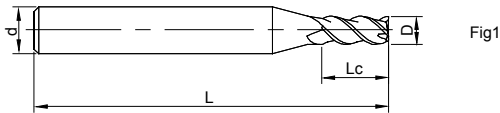

See page 97 for guidelines to

Ordering Code	D	Lc	L	d	Figure No.	Stock
UP100-S3-02006	2	6	50	4	1	○
UP100-S3-03009	3	9	50	4	1	○
UP100-S3-04011	4	11	50	4	2	○
UP100-S3-05013	5	13	50	6	1	○
UP100-S3-06016	6	16	50	6	2	●
UP100-S3-06516	6.5	16	60	8	1	○
UP100-S3-08020	8	20	60	8	2	●
UP100-S3-09524	9.5	24	75	10	1	○
UP100-S3-10025	10	25	75	10	2	○
UP100-S3-12030	12	30	75	12	2	○
UP100-S3-16036	16	36	100	16	2	○
UP100-S3-18040	18	40	100	18	2	○
UP100-S3-20045	20	45	100	20	2	○
UP100-S3-25050	25	50	100	25	2	○

● Stock ○ Available upon Order

D	Tol
D 12	0 -0.02
D > 12	0 -0.03

unit (mm)

Workpiece Material						
P		M	K	N		
1234	5	123	123	123	4	5
Carbon Steel, Alloy Steel (<35 HRC)	Alloy Steel, Tool Steel (<48HRC)	Stainless Steel	Cast Iron	Aluminium Alloys	Copper Alloys	Graphite
⊙	○	○	⊙	○	○	

● Most Suitable ○ Suitable

Cutting Parameters ※ P421

UP100-S4

4 Flute, Standard Length

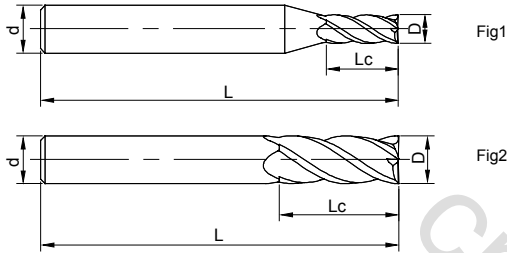

See page 97 for guidelines to icons

Ordering Code	D	Lc	L	d	Figure No.	Stock
UP100-S4-01003	1	3	50	4	1	○
UP100-S4-01505	1.5	5	50	4	1	○
UP100-S4-02006	2	6	50	4	1	●
UP100-S4-02508	2.5	8	50	4	1	●
UP100-S4-03006	3	6	50	4	1	○
UP100-S4-03009	3	9	50	4	1	○
UP100-S4-63006	3	6	50	6	1	○
UP100-S4-63009	3	9	50	6	1	○
UP100-S4-03511	3.5	11	50	4	1	○
UP100-S4-63509	3.5	9	50	6	1	○
UP100-S4-64008	4	8	50	6	1	●
UP100-S4-04010	4	10	50	4	2	●
UP100-S4-04011	4	11	50	4	2	●
UP100-S4-64011	4	11	50	6	1	○
UP100-S4-04511	4.5	11	50	6	1	○
UP100-S4-05008	5	8	50	6	1	○

● Stock ○ Available upon Order

D	Tol
D 12	0 -0.02
D > 12	0 -0.03

unit (mm)

Workpiece Material						
P		M	K	N		
1234	5	123	123	123	4	5
Carbon Steel, Alloy Steel (<35 HRC)	Alloy Steel, Tool Steel (<48HRC)	Stainless Steel	Cast Iron	Aluminium Alloys	Copper Alloys	Graphite
⊙	○	○	⊙	○	○	

⊙ Most Suitable ○ Suitable

Cutting Parameters ※ P422

UP100-S4

4 Flute, Standard Length

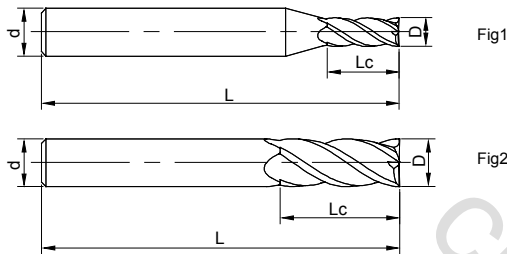

See page 97 for guidelines to icons

» continue

Ordering Code	D	Lc	L	d	Figure No.	Stock
UP100-S4-05013	5	13	50	6	1	●
UP100-S4-05513	5.5	13	50	6	1	○
UP100-S4-06016	6	16	50	6	2	●
UP100-S4-06516	6.5	16	60	8	1	○
UP100-S4-07020	7	20	60	8	1	○
UP100-S4-07520	7.5	20	60	8	1	○
UP100-S4-08020	8	20	60	8	2	●
UP100-S4-08523	8.5	23	75	10	1	○
UP100-S4-09023	9	23	75	10	1	○
UP100-S4-09525	9.5	25	75	10	1	○
UP100-S4-10025	10	25	75	10	2	●
UP100-S4-11028	11	28	75	12	1	○
UP100-S4-12030	12	30	75	12	2	●
UP100-S4-13032	13	32	90	14	1	●
UP100-S4-14034	14	34	100	14	2	●
UP100-S4-15036	15	36	100	16	1	○

● Stock ○ Available upon Order

D	Tol
D 12	0 -0.02
D > 12	0 -0.03

unit (mm)

Workpiece Material						
P		M	K	N		
1234	5	123	123	123	4	5
Carbon Steel, Alloy Steel (<35 HRC)	Alloy Steel, Tool Steel (<48HRC)	Stainless Steel	Cast Iron	Aluminium Alloys	Copper Alloys	Graphite
⊙	○	○	⊙	○	○	

⊙ Most Suitable ○ Suitable

Cutting Parameters ※ P422

UP100-S4

4 Flute, Standard Length

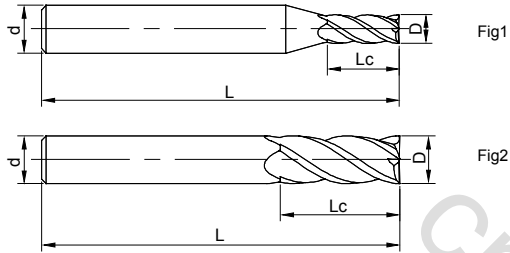

See page 97 for guidelines to icons

» continue

Ordering Code	D	Lc	L	d	Figure No.	Stock
UP100-S4-16036	16	36	100	16	2	●
UP100-S4-17038	17	38	100	18	1	○
UP100-S4-18038	18	38	100	18	2	●
UP100-S4-20045	20	45	100	20	2	●

● Stock ○ Available upon Order

D	Tol
D 12	0 -0.02
D > 12	0 -0.03

unit (mm)

Workpiece Material						
P		M	K	N		
1234	5	123	123	123	4	5
Carbon Steel, Alloy Steel (<35 HRC)	Alloy Steel, Tool Steel (<48 HRC)	Stainless Steel	Cast Iron	Aluminium Alloys	Copper Alloys	Graphite
⊙	○	○	⊙	○	○	

⊙ Most Suitable ○ Suitable

Cutting Parameters ※ P422

UP100-SL4

4 Flute, With Long Flute Length

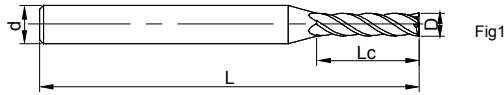

Fig1

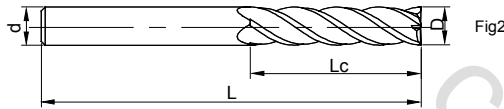

Fig2



See page 97 for guidelines to icons

Ordering Code	D	Lc	L	d	Figure No.	Stock
UP100-SL4-04030	4	30	75	4	2	●
UP100-SL4-05030	5	30	75	6	1	○
UP100-SL4-06030	6	30	100	6	2	●
UP100-SL4-06035	6	35	75	6	2	○
UP100-SL4-08040	8	40	100	8	2	●
UP100-SL4-10045	10	45	100	10	2	●
UP100-SL4-12040	12	40	150	12	2	●
UP100-SL4-12050	12	50	100	12	2	○
UP100-SL4-16050	16	50	150	16	2	○
UP100-SL4-16060	16	60	150	16	2	○
UP100-SL4-20070	20	70	150	20	2	○

● Stock ○ Available upon Order

D	Tol
D 12	0 -0.02
D > 12	0 -0.03

unit (mm)

Workpiece Material

P		M	K	N		
1234	5	123	123	123	4	5
Carbon Steel, Alloy Steel (<35 HRC)	Alloy Steel, Tool Steel (<48HRC)	Stainless Steel	Cast Iron	Aluminium Alloys	Copper Alloys	Graphite
⊙	○	○	⊙	○	○	

⊙ Most Suitable ○ Suitable

Cutting Parameters ※ P422

UP100-SH4

4 Flute, with Long Shank Length

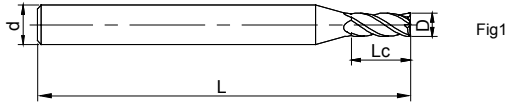

Fig1

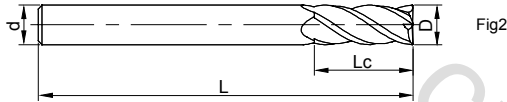

Fig2



See page 97 for guidelines to icons

Ordering Code	D	Lc	L	d	Figure No.	Stock
UP100-SH4-03009	3	9	75	4	1	○
UP100-SH4-63012	3	12	75	6	1	●
UP100-SH4-04011	4	11	75	4	2	○
UP100-SH4-64015	4	15	75	6	1	○
UP100-SH4-05020	5	20	75	6	1	○
UP100-SH4-06016	6	16	100	6	2	○
UP100-SH4-06020	6	20	75	6	2	○
UP100-SH4-08020	8	20	75	8	2	○
UP100-SH4-08025	8	25	100	8	2	○
UP100-SH4-10030	10	30	100	10	2	●
UP100-SH4-10035	10	35	150	10	2	●
UP100-SH4-12035	12	35	100	12	2	○
UP100-SH4-16036	16	36	150	16	2	○
UP100-SH4-20045	20	45	150	20	2	○

● Stock ○ Available upon Order

D	Tol
D 12	0 -0.02
D > 12	0 -0.03

unit (mm)

Workpiece Material

P		M	K	N		
1234	5	123	123	123	4	5
Carbon Steel, Alloy Steel (<35 HRC)	Alloy Steel, Tool Steel (<48HRC)	Stainless Steel	Cast Iron	Aluminium Alloys	Copper Alloys	Graphite
⊙	○	○	⊙	○	○	

⊙ Most Suitable ○ Suitable

Cutting Parameters ※ P422

UP100-S6

6 Flute, Standard Length

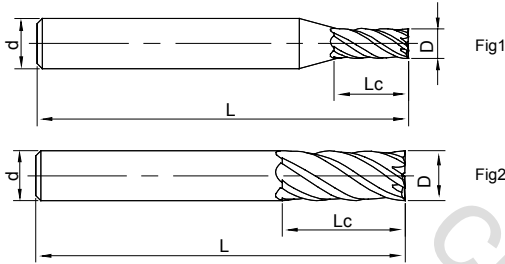

See page 97 for guidelines to icons

Ordering Code	D	Lc	L	d	Figure No.	Stock
UP100-S6-06015	6	15	50	6	2	○
UP100-S6-08020	8	20	60	8	2	○
UP100-S6-10025	10	25	75	10	2	○
UP100-S6-12030	12	30	75	12	2	○
UP100-S6-16036	16	36	100	16	2	○
UP100-S6-20045	20	45	100	20	2	○

● Stock ○ Available upon Order

D	Tol
D 12	0 -0.02
D > 12	0 -0.03

unit (mm)

Workpiece Material						
P		M	K	N		
1234	5	123	123	123	4	5
Carbon Steel, Alloy Steel (<35 HRC)	Alloy Steel, Tool Steel (<48HRC)	Stainless Steel	Cast Iron	Aluminium Alloys	Copper Alloys	Graphite
⊙	○	○	⊙	○	○	

● Most Suitable ○ Suitable

Cutting Parameters ※ P422

UP210-SS2

2 Flute, Stub Length

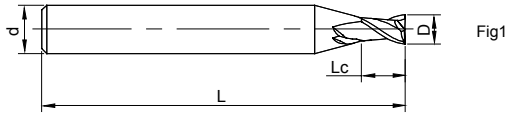

Fig1

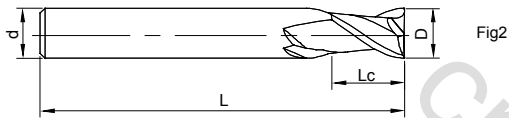

Fig2



See page 97 for guidelines to icons

Ordering Code	D	Lc	L	d	Figure No.	Stock
UP210-SS2-01002	1	2	50	4	1	○
UP210-SS2-01502	1.5	2	50	4	1	○
UP210-SS2-02003	2	3	50	4	1	○
UP210-SS2-02504	2.5	4	50	4	1	○
UP210-SS2-03005	3	5	50	4	1	○
UP210-SS2-04006	4	6	50	4	2	●
UP210-SS2-05008	5	8	50	6	1	●
UP210-SS2-06009	6	9	50	6	2	●
UP210-SS2-07010	7	10	60	8	1	○
UP210-SS2-08012	8	12	60	8	2	●
UP210-SS2-10015	10	15	75	10	2	●
UP210-SS2-12018	12	18	75	12	2	○
UP210-SS2-14021	14	21	100	14	2	○
UP210-SS2-16024	16	24	100	16	2	○
UP210-SS2-18027	18	27	100	18	2	○
UP210-SS2-20030	20	30	100	20	2	○

●Stock ○Available upon Order

D	Tol
D 12	0 -0.02
D > 12	0 -0.03

unit (mm)

Workpiece Material						
P		M	K	N		
1234	5	123	123	123	4	5
Carbon Steel, Alloy Steel(<35 HRC)	Alloy Steel, Tool Steel(<48HRC)	Stainless Steel	Cast Iron	Aluminium Alloys	Copper Alloys	Graphite
⊙	⊙	○	⊙			

⊙ Most Suitable ○ Suitable

Cutting Parameters ✖ P425

UP210-S2

2 Flute, Standard Length

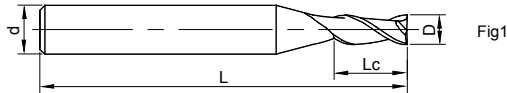

Fig1

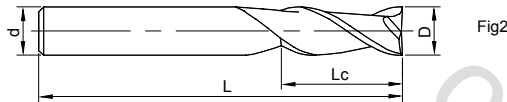

Fig2



See page 97 for guidelines to icons

Ordering Code	D	Lc	L	d	Figure No.	Stock
UP210-S2-01003	1	3	50	4	1	●
UP210-S2-01504	1.5	4	50	4	1	●
UP210-S2-02006	2	6	50	4	1	●
UP210-S2-02506	2.5	6	50	4	1	○
UP210-S2-02508	2.5	8	50	4	1	●
UP210-S2-03009	3	9	50	4	1	●
UP210-S2-63009	3	9	50	6	1	●
UP210-S2-03509	3.5	9	50	4	1	○
UP210-S2-63509	3.5	9	50	6	1	○
UP210-S2-04011	4	11	50	4	2	●
UP210-S2-64011	4	11	50	6	1	●
UP210-S2-04511	4.5	11	50	6	1	○
UP210-S2-04513	4.5	13	50	6	1	●
UP210-S2-05013	5	13	50	6	1	●
UP210-S2-05516	5.5	16	50	6	1	○
UP210-S2-06016	6	16	50	6	2	●

● Stock ○ Available upon Order

D	Tol
D ≤ 12	0 -0.02
D > 12	0 -0.03

unit (mm)

Workpiece Material						
P		M	K	N		
1234	5	123	123	123	4	5
Carbon Steel, Alloy Steel (<35 HRC)	Alloy Steel, Tool Steel (<48HRC)	Stainless Steel	Cast Iron	Aluminium Alloys	Copper Alloys	Graphite
⊙	⊙	○	⊙			

● Most Suitable ○ Suitable

Cutting Parameters ※ P425

UP210-S2

2 Flute, Standard Length

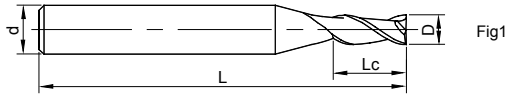

Fig1

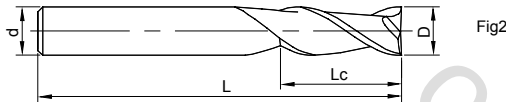

Fig2



See page 97 for guidelines to icons

» continue

Ordering Code	D	Lc	L	d	Figure No.	Stock
UP210-S2-06516	6.5	16	60	8	1	○
UP210-S2-07020	7	20	60	8	1	●
UP210-S2-07520	7.5	20	60	8	1	○
UP210-S2-08020	8	20	60	8	2	●
UP210-S2-08523	8.5	23	75	10	1	○
UP210-S2-09023	9	23	75	10	1	●
UP210-S2-09525	9.5	25	75	10	1	○
UP210-S2-10025	10	25	75	10	2	●
UP210-S2-10526	10.5	26	75	12	1	○
UP210-S2-11028	11	28	75	12	1	●
UP210-S2-12030	12	30	75	12	2	●
UP210-S2-13032	13	32	100	14	1	○
UP210-S2-14034	14	34	100	14	2	●
UP210-S2-15036	15	36	100	16	1	○
UP210-S2-16036	16	36	100	16	2	●
UP210-S2-17040	17	40	100	20	1	○

● Stock ○ Available upon Order

D	Tol
D 12	0 -0.02
D > 12	0 -0.03

unit (mm)

Workpiece Material						
P		M	K	N		
1234	5	123	123	123	4	5
Carbon Steel, Alloy Steel (<35 HRC)	Alloy Steel, Tool Steel (<48HRC)	Stainless Steel	Cast Iron	Aluminium Alloys	Copper Alloys	Graphite
⊙	⊙	○	⊙			

⊙ Most Suitable ○ Suitable

Cutting Parameters ※ P425

UP210-S2

2 Flute, Standard Length

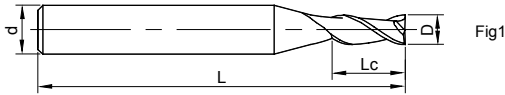

Fig1

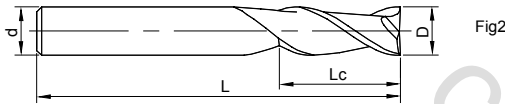

Fig2



See page 97 for guidelines to icons

» continue

Ordering Code	D	Lc	L	d	Figure No.	Stock
UP210-S2-18040	18	40	100	18	2	●
UP210-S2-19040	19	40	100	20	1	○
UP210-S2-20045	20	45	100	20	2	●

● Stock ○ Available upon Order

D	Tol
D 12	0 -0.02
D > 12	0 -0.03

unit (mm)

Workpiece Material						
P		M	K	N		
1234	5	123	123	123	4	5
Carbon Steel, Alloy Steel (<35 HRC)	Alloy Steel, Tool Steel (<48HRC)	Stainless Steel	Cast Iron	Aluminium Alloys	Copper Alloys	Graphite
⊙	⊙	○	⊙			

⊙ Most Suitable ○ Suitable

Cutting Parameters ※ P425

UP210-SL2

2 Flute, With Long Flute Length

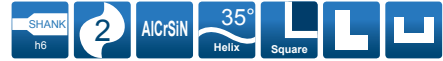
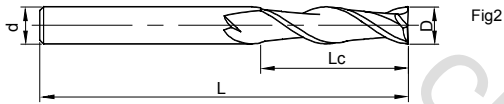
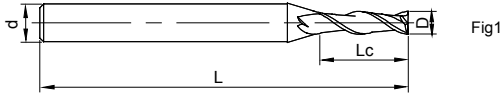

See page 97 for guidelines to icons

Ordering Code	D	Lc	L	d	Figure No.	Stock
UP210-SL2-02015	2	15	75	4	1	●
UP210-SL2-03025	3	25	75	4	1	●
UP210-SL2-04030	4	30	75	4	2	●
UP210-SL2-05030	5	30	75	6	1	●
UP210-SL2-06035	6	35	75	6	2	●
UP210-SL2-08040	8	40	100	8	2	●
UP210-SL2-10045	10	45	100	10	2	●
UP210-SL2-12050	12	50	100	12	2	●
UP210-SL2-14055	14	55	100	14	2	●
UP210-SL2-16050	16	50	150	16	2	○
UP210-SL2-16060	16	60	150	16	2	●
UP210-SL2-18065	18	65	150	18	2	○
UP210-SL2-20070	20	70	150	20	2	●

● Stock ○ Available upon Order

D	Tol
D 12	0 -0.02
D > 12	0 -0.03

unit (mm)

Workpiece Material

P		M	K	N		
1234	5	123	123	123	4	5
Carbon Steel, Alloy Steel (<35 HRC)	Alloy Steel, Tool Steel (<48HRC)	Stainless Steel	Cast Iron	Aluminium Alloys	Copper Alloys	Graphite
⊙	⊙	○	⊙			

● Most Suitable ○ Suitable

Cutting Parameters ※ P425

UP210-SH2

2 Flute, with Long Shank Length

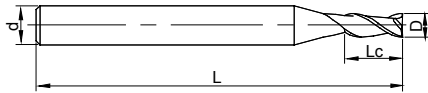

Fig1

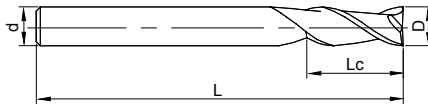

Fig2



See page 97 for guidelines to icons

Ordering Code	D	Lc	L	d	Figure No.	Stock
UP210-SH2-02006	2	6	75	4	1	●
UP210-SH2-03009	3	9	75	4	1	●
UP210-SH2-63012	3	12	75	6	1	○
UP210-SH2-04011	4	11	75	4	2	●
UP210-SH2-05020	5	20	75	6	1	○
UP210-SH2-06016	6	16	100	6	2	●
UP210-SH2-06020	6	20	100	6	2	●
UP210-SH2-08020	8	20	100	8	2	○
UP210-SH2-08025	8	25	100	8	2	●
UP210-SH2-10030	10	30	100	10	2	●
UP210-SH2-12035	12	35	100	12	2	●
UP210-SH2-14036	14	36	150	14	2	○
UP210-SH2-15035	15	35	150	16	1	●
UP210-SH2-16036	16	36	150	16	2	○
UP210-SH2-18045	18	45	150	18	2	●
UP210-SH2-20045	20	45	150	20	2	○

● Stock ○ Available upon Order

D	Tol
D 12	0 -0.02
D > 12	0 -0.03

unit (mm)

Workpiece Material						
P		M	K	N		
1234	5	123	123	123	4	5
Carbon Steel, Alloy Steel (<35 HRC)	Alloy Steel, Tool Steel (<48HRC)	Stainless Steel	Cast Iron	Aluminium Alloys	Copper Alloys	Graphite
⊙	⊙	○	⊙			

⊙ Most Suitable ○ Suitable

Cutting Parameters ※ P425

UP210-S3

3 Flute, Standard Length

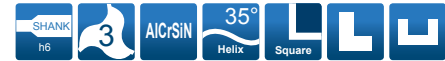
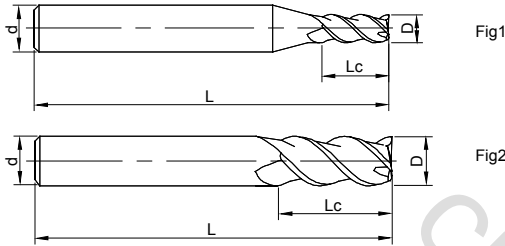

See page 97 for guidelines to icons

Ordering Code	D	Lc	L	d	Figure No.	Stock
UP210-S3-02006	2	6	50	4	1	○
UP210-S3-03009	3	9	50	4	1	●
UP210-S3-04011	4	11	50	4	2	●
UP210-S3-05013	5	13	50	6	1	●
UP210-S3-06016	6	16	50	6	2	●
UP210-S3-06516	6.5	16	60	8	1	○
UP210-S3-08020	8	20	60	8	2	●
UP210-S3-09524	9.5	24	75	10	1	○
UP210-S3-10025	10	25	75	10	2	●
UP210-S3-12030	12	30	75	12	2	●
UP210-S3-14032	14	32	100	14	2	○
UP210-S3-16036	16	36	100	16	2	○
UP210-S3-18040	18	40	100	18	2	○
UP210-S3-20045	20	45	100	20	2	●
UP210-S3-25050	25	50	100	25	2	○

●Stock ○Available upon Order

D	Tol
D 12	0 -0.02
D > 12	0 -0.03

unit (mm)

Workpiece Material						
P		M	K	N		
1234	5	123	123	123	4	5
Carbon Steel, Alloy Steel(<35 HRC)	Alloy Steel, Tool Steel(<48HRC)	Stainless Steel	Cast Iron	Aluminium Alloys	Copper Alloys	Graphite
⊙	⊙	○	⊙			

● Most Suitable ○ Suitable

Cutting Parameters ※ P425

UP210-SS4

4 Flute, Stub Length

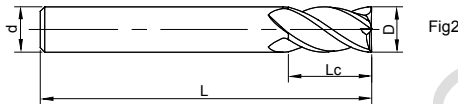
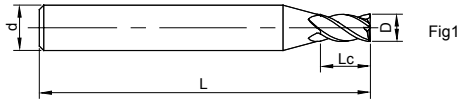

See page 97 for guidelines to icons

Ordering Code	D	Lc	L	d	Figure No.	Stock
UP210-SS4-01002	1	2	50	4	1	○
UP210-SS4-01502	1.5	2	50	4	1	○
UP210-SS4-02003	2	3	50	4	1	○
UP210-SS4-02504	2.5	4	50	4	1	○
UP210-SS4-03005	3	5	50	4	1	○
UP210-SS4-04006	4	6	50	4	2	○
UP210-SS4-05008	5	8	50	6	1	○
UP210-SS4-06009	6	9	50	6	2	●
UP210-SS4-07010	7	10	60	8	1	○
UP210-SS4-08012	8	12	60	8	2	○
UP210-SS4-10015	10	15	75	10	2	○
UP210-SS4-12018	12	18	75	12	2	●
UP210-SS4-14021	14	21	100	14	2	○
UP210-SS4-16024	16	24	100	16	2	○
UP210-SS4-18027	18	27	100	18	2	○
UP210-SS4-20030	20	30	100	20	2	○

● Stock ○ Available upon Order

D	Tol
D 12	0 -0.02
D > 12	0 -0.03

unit (mm)

Workpiece Material						
P		M	K	N		
1234	5	123	123	123	4	5
Carbon Steel, Alloy Steel (<35 HRC)	Alloy Steel, Tool Steel (<48HRC)	Stainless Steel	Cast Iron	Aluminium Alloys	Copper Alloys	Graphite
⊙	⊙	○	⊙			

⊙ Most Suitable ○ Suitable

Cutting Parameters ※ P426

UP210-S4

4 Flute, Standard Length

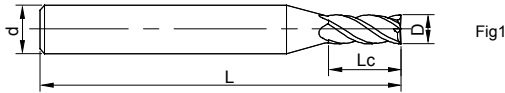

Fig1

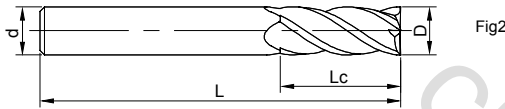

Fig2



See page 97 for guidelines to icons

Ordering Code	D	Lc	L	d	Figure No.	Stock
UP210-S4-01003	1	3	50	4	1	●
UP210-S4-01505	1.5	5	50	4	1	●
UP210-S4-61505	1.5	5	50	6	1	●
UP210-S4-02006	2	6	50	4	1	●
UP210-S4-62006	2	6	50	6	1	●
UP210-S4-02508	2.5	8	50	4	1	●
UP210-S4-62508	2.5	8	50	6	1	●
UP210-S4-63006	3	6	50	6	1	○
UP210-S4-03009	3	9	50	4	1	●
UP210-S4-63009	3	9	50	6	1	●
UP210-S4-03511	3.5	11	50	4	1	●
UP210-S4-63509	3.5	9	50	6	1	●
UP210-S4-04011	4	11	50	4	2	●
UP210-S4-64011	4	11	50	6	1	●
UP210-S4-04511	4.5	11	50	6	1	○
UP210-S4-05008	5	8	50	6	1	●

● Stock ○ Available upon Order

D	Tol
D 12	0 -0.02
D > 12	0 -0.03

unit (mm)

Workpiece Material

P		M	K	N		
1234	5	123	123	123	4	5
Carbon Steel, Alloy Steel (<35 HRC)	Alloy Steel, Tool Steel (<48HRC)	Stainless Steel	Cast Iron	Aluminium Alloys	Copper Alloys	Graphite
⊙	⊙	○	⊙			

⊙ Most Suitable ○ Suitable

Cutting Parameters ※ P426

UP210-S4

4 Flute, Standard Length

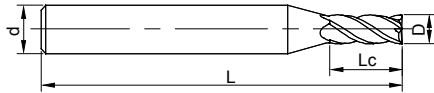

Fig1

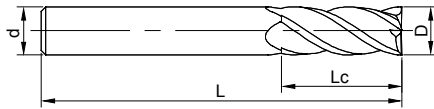

Fig2



See page 97 for guidelines to icons

» continue

Ordering Code	D	Lc	L	d	Figure No.	Stock
UP210-S4-05013	5	13	50	6	1	●
UP210-S4-05516	5.5	16	50	6	1	●
UP210-S4-06016	6	16	50	6	2	●
UP210-S4-06516	6.5	16	60	8	1	●
UP210-S4-07020	7	20	60	8	1	●
UP210-S4-07520	7.5	20	60	8	1	○
UP210-S4-08020	8	20	60	8	2	●
UP210-S4-08523	8.5	23	75	10	1	○
UP210-S4-09023	9	23	75	10	1	●
UP210-S4-09525	9.5	25	75	10	1	○
UP210-S4-10025	10	25	75	10	2	●
UP210-S4-11028	11	28	75	12	1	●
UP210-S4-12030	12	30	75	12	2	●
UP210-S4-13032	13	32	100	14	1	●
UP210-S4-14032	14	32	75	14	2	○
UP210-S4-14034	14	34	100	14	2	●

● Stock ○ Available upon Order

D	Tol
D 12	0 -0.02
D > 12	0 -0.03

unit (mm)

Workpiece Material

P		M	K	N		
1234	5	123	123	123	4	5
Carbon Steel, Alloy Steel (<35 HRC)	Alloy Steel, Tool Steel (<48HRC)	Stainless Steel	Cast Iron	Aluminium Alloys	Copper Alloys	Graphite
⊙	⊙	○	⊙			

● Most Suitable ○ Suitable

Cutting Parameters ※ P426

UP210-S4

4 Flute, Standard Length

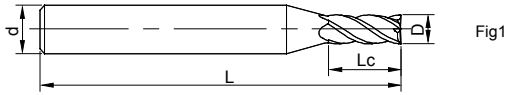

Fig1

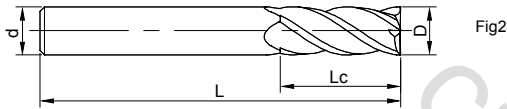

Fig2



See page 97 for guidelines to icons

» continue

Ordering Code	D	Lc	L	d	Figure No.	Stock
UP210-S4-15036	15	36	100	16	1	●
UP210-S4-16036	16	36	100	16	2	●
UP210-S4-16040	16	40	100	16	2	●
UP210-S4-16045	16	45	100	16	2	●
UP210-S4-17038	17	38	100	18	1	○
UP210-S4-18045	18	45	100	18	2	●
UP210-S4-20045	20	45	100	20	2	●

● Stock ○ Available upon Order

D	Tol
D 12	0 -0.02
D > 12	0 -0.03

unit (mm)

Workpiece Material						
P		M	K	N		
1234	5	123	123	123	4	5
Carbon Steel, Alloy Steel (<35 HRC)	Alloy Steel, Tool Steel (<48HRC)	Stainless Steel	Cast Iron	Aluminium Alloys	Copper Alloys	Graphite
◎	◎	○	◎			

◎ Most Suitable ○ Suitable

Cutting Parameters ※ P426

UP210-SL4

4 Flute, Long Flute Length

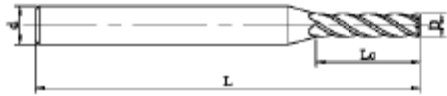

Fig1

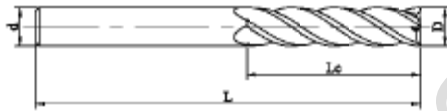

Fig2



See page 97 for guidelines to icons

Ordering Code	D	Lc	L	d	Figure No.	Stock
UP210-SL4-01004	1	4	50	4	1	●
UP210-SL4-02010	2	10	50	4	1	●
UP210-SL4-03015	3	15	60	4	1	●
UP210-SL4-63015	3	15	60	6	1	●
UP210-SL4-04020	4	20	60	4	2	●
UP210-SL4-64020	4	20	75	6	1	●
UP210-SL4-04030	4	30	75	4	2	○
UP210-SL4-05025	5	25	75	6	1	●
UP210-SL4-05030	5	30	75	6	1	○
UP210-SL4-06030	6	30	75	6	2	●
UP210-SL4-06035	6	35	75	6	2	●
UP210-SL4-08035	8	35	100	8	2	●

● Stock ○ Available upon Order

D	Tol
D ≤ 12	0 -0.02
D > 12	0 -0.03

unit (mm)

Workpiece Material

P		M	K	N		
1234	5	123	123	123	4	5
Carbon Steel, Alloy Steel (<35 HRC)	Alloy Steel, Tool Steel (<48HRC)	Stainless Steel	Cast Iron	Aluminium Alloys	Copper Alloys	Graphite
●	●	○	●			

● Most Suitable ○ Suitable

Cutting Parameters ※ P426

UP210-SL4

4 Flute, With Long Flute Length

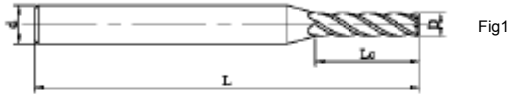

Fig1

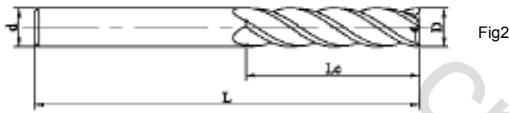

Fig2



See page 97 for guidelines to icons

» continue

Ordering Code	D	Lc	L	d	Figure No.	Stock
UP210-SL4-08040	8	40	100	8	2	●
UP210-SL4-10045	10	45	100	10	2	●
UP210-SL4-10050	10	50	100	10	2	●
UP210-SL4-12045	12	45	100	12	2	●
UP210-SL4-12050	12	50	100	12	2	●
UP210-SL4-14045	14	45	100	14	2	●
UP210-SL4-16050	16	50	150	16	2	○
UP210-SL4-16060	16	60	150	16	2	●
UP210-SL4-16070	16	70	150	16	2	●
UP210-SL4-18070	18	70	150	18	2	○
UP210-SL4-20070	20	70	150	20	2	●

● Stock ○ Available upon Order

D	Tol
D 12	0 -0.02
D > 12	0 -0.03

unit (mm)

Workpiece Material

P		M	K	N		
1234	5	123	123	123	4	5
Carbon Steel, Tool Steel(<35 HRC)	Carbon Steel, Tool Steel(<35 HRC)	Stainless Steel	Cast Iron	Aluminium Alloys	Copper Alloys	Graphite
⊙	⊙	○	⊙			

● Most Suitable ○ Most Suitable

Cutting Parameters ※ P426

UP210-SH4

4 Flute, with Long Shank Length

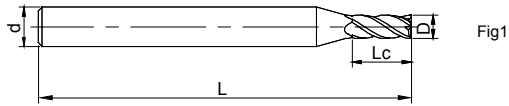

Fig1

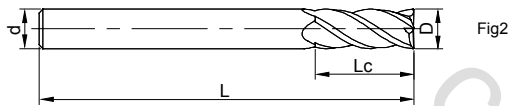

Fig2



See page 97 for guidelines to icons

Ordering Code	D	Lc	L	d	Figure No.	Stock
UP210-SH4-02010	2	10	75	4	1	●
UP210-SH4-03012	3	12	75	4	1	●
UP210-SH4-04011	4	11	75	4	2	●
UP210-SH4-04015	4	15	75	4	2	●
UP210-SH4-05020	5	20	75	6	1	●
UP210-SH4-06016	6	16	75	6	2	●
UP210-SH4-06020	6	20	75	6	2	○
UP210-SH4-08020	8	20	100	8	2	●
UP210-SH4-08025	8	25	100	8	2	●
UP210-SH4-10030	10	30	100	10	2	●
UP210-SH4-10035	10	35	100	10	2	○
UP210-SH4-12035	12	35	100	12	2	●
UP210-SH4-14036	14	36	150	14	2	○
UP210-SH4-16036	16	36	150	16	2	●
UP210-SH4-18045	18	45	150	18	2	○
UP210-SH4-20045	20	45	150	20	2	●

● Stock ○ Available upon Order

D	Tol
D 12	0 -0.02
D > 12	0 -0.03

unit (mm)

Workpiece Material						
P		M	K	N		
1234	5	123	123	123	4	5
Carbon Steel, Tool Steel(<35 HRC)	Carbon Steel, Tool Steel(<35 HRC)	Stainless Steel	Cast Iron	Aluminium Alloys	Copper Alloys	Graphite
●	●	○	●			

● Most Suitable ○ Most Suitable

Cutting Parameters ※ P426

UP210-S6

6 Flute, Standard Length

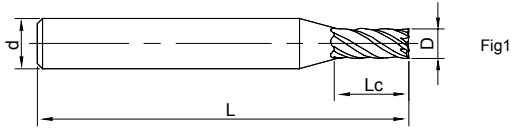

Fig1

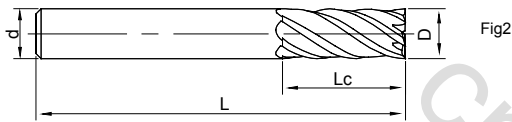

Fig2



See page 97 for guidelines to icons

Ordering Code	D	Lc	L	d	Figure No.	Stock
UP210-S6-06015	6	15	50	6	2	○
UP210-S6-08020	8	20	60	8	2	○
UP210-S6-10025	10	25	75	10	2	○
UP210-S6-12030	12	30	75	12	2	○
UP210-S6-14032	14	32	100	14	2	○
UP210-S6-16036	16	36	100	16	2	○
UP210-S6-18040	18	40	100	18	2	○
UP210-S6-20045	20	45	100	20	2	○

●Stock ○Available upon Order

D	Tol
D 12	0 -0.02
D > 12	0 -0.03

unit (mm)

Workpiece Material						
P		M	K	N		
1234	5	123	123	123	4	5
Carbon Steel, Alloy Steel (<35 HRC)	Alloy Steel, Tool Steel (<48HRC)	Stainless Steel	Cast Iron	Aluminium Alloys	Copper Alloys	Graphite
⊙	⊙	○	⊙			

● Most Suitable ○ Most Suitable

Cutting Parameters ※ P426

SP210-S3

3 Flute, with Variable Helix

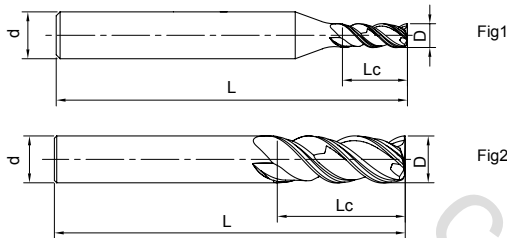

See page 97 for guidelines to icons

Ordering Code	D	Lc	L	d	Figure No.	Stock
SP210-S3-02508	2.5	8	50	4	1	○
SP210-S3-03009	3	9	50	4	1	●
SP210-S3-04011	4	11	50	4	2	●
SP210-S3-05013	5	13	50	6	1	●
SP210-S3-06016	6	16	50	6	2	●
SP210-S3-08020	8	20	60	8	2	●
SP210-S3-10025	10	25	75	10	2	●
SP210-S3-12030	12	30	75	12	2	●
SP210-S3-16036	16	36	100	16	2	●
SP210-S3-20045	20	45	100	20	2	●

● Stock ○ Available upon Order

D	Tol
D ≤ 12	0 -0.02
D > 12	0 -0.03

unit (mm)

Workpiece Material						
P		M	K	N		
1234	5	123	123	123	4	5
Carbon Steel, Alloy Steel (<35 HRC)	Alloy Steel, Tool Steel (<48HRC)	Stainless Steel	Cast Iron	Aluminium Alloys	Copper Alloys	Graphite
⊙	⊙	○	⊙			

⊙ Most Suitable ○ Most Suitable

Cutting Parameters ※ P429

SP210-C3

3 Flute, with Variable Helix (Chamfered Corner)

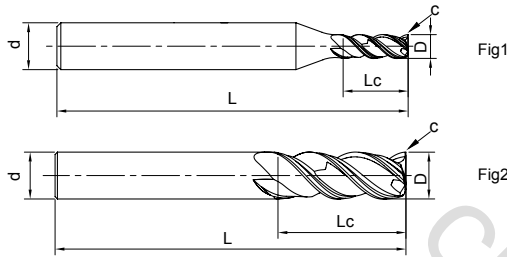

See page 97 for guidelines to icons

Ordering Code	D	Lc	C	L	d	Figure No.	Stock
SP210-C3-06020	6	16	0.2	50	6	2	●
SP210-C3-08020	8	20	0.2	75	8	2	●
SP210-C3-10030	10	25	0.3	75	10	2	●
SP210-C3-12030	12	30	0.3	75	12	2	●
SP210-C3-16030	16	30	0.3	100	16	2	○

● Stock ○ Available upon Order

D	Tol
D 12	0 -0.02
D > 12	0 -0.03

unit (mm)

Workpiece Material						
P		M	K	N		
1234	5	123	123	123	4	5
Carbon Steel, Alloy Steel (<35 HRC)	Alloy Steel, Tool Steel (<48HRC)	Stainless Steel	Cast Iron	Aluminium Alloys	Copper Alloys	Graphite
⊙	⊙	○	⊙			

● Most Suitable ○ Most Suitable

Cutting Parameters ※ P429

SP210-C4

4 Flute, with Variable Helix

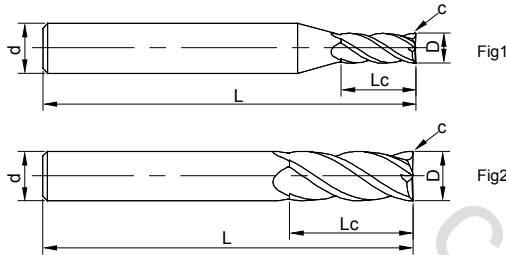

See page 97 for guidelines to icons

Ordering Code	D	Lc	C	L	d	Figure No.	Stock
SP210-C4-03003	3	9	0.03	50	4	1	○
SP210-C4-03013	3	9	0.13	50	4	1	●
SP210-C4-04004	4	11	0.04	50	4	2	●
SP210-C4-04018	4	11	0.18	50	4	2	●
SP210-C4-05005	5	13	0.05	50	6	1	○
SP210-C4-05020	5	13	0.2	50	6	1	○
SP210-C4-06006	6	16	0.06	50	6	2	●
SP210-C4-06020	6	16	0.2	50	6	2	●
SP210-C4-06040	6	16	0.4	50	6	2	○
SP210-C4-08008	8	20	0.08	60	8	2	●
SP210-C4-08020	8	20	0.2	60	8	2	●
SP210-C4-10010	10	25	0.1	75	10	2	●
SP210-C4-10030	10	25	0.3	75	10	2	●
SP210-C4-12012	12	30	0.12	75	12	2	○
SP210-C4-12030	12	30	0.3	75	12	2	●
SP210-C4-16015	16	36	0.15	100	16	2	○

● Stock ○ Available upon Order

D	Tol
D 12	0 -0.02
D > 12	0 -0.03

unit (mm)

Workpiece Material						
P		M	K	N		
1234	5	123	123	123	4	5
Carbon Steel, Alloy Steel (<35 HRC)	Alloy Steel, Tool Steel (<48HRC)	Stainless Steel	Cast Iron	Aluminium Alloys	Copper Alloys	Graphite
⊙	⊙	○	⊙			

⊙ Most Suitable ○ Most Suitable

Cutting Parameters ※ P429

SP210-C4

4 Flute, Variable Helix (Chamfered Corner)

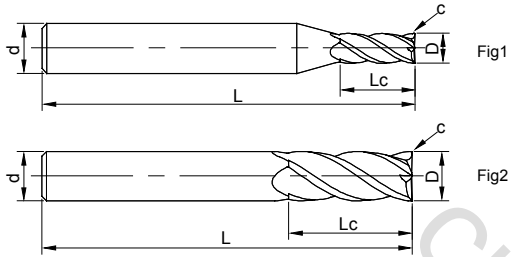

See page 97 for guidelines to icons

» continue

Ordering Code	D	Lc	C	L	d	Figure No.	Stock
SP210-C4-16040	16v	36	0.4	100	16	2	○
SP210-C4-20015	20	45	0.15	100	20	2	○
SP210-C4-20050	20	45	0.5	100	20	2	○

●Stock ○Available upon Order

D	Tol
D 12	0 -0.02
D > 12	0 -0.03

unit (mm)

Workpiece Material						
P		M	K	N		
1234	5	123	123	123	4	5
Carbon Steel, Alloy Steel(<35 HRC)	Alloy Steel, Tool Steel(<48HRC)	Stainless Steel	Cast Iron	Aluminium Alloys	Copper Alloys	Graphite
⊙	⊙	○	⊙			

● Most Suitable ○ Suitable

Cutting Parameters ※ P429

SP210-S4

4 Flute, with Variable Helix

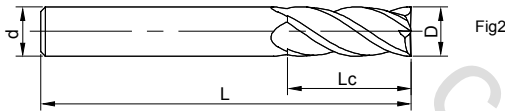
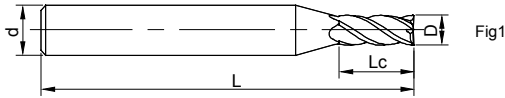

See page 97 for guidelines to icons

Ordering Code	D	Lc	L	d	Figure No.	Stock
SP210-S4-02006	2	6	50	4	1	●
SP210-S4-03009	3	9	50	4	1	●
SP210-S4-04011	4	11	50	4	2	●
SP210-S4-05013	5	13	50	6	1	●
SP210-S4-05516	5.5	16	50	6	1	○
SP210-S4-06016	6	16	50	6	2	●
SP210-S4-07020	7	20	60	8	1	○
SP210-S4-08020	8	20	60	8	2	●
SP210-S4-08025	8	25	60	8	2	○
SP210-S4-10025	10	25	75	10	2	●
SP210-S4-12030	12	30	75	12	2	●
SP210-S4-16036	16	36	100	16	2	●
SP210-S4-20045	20	45	100	20	2	●

● Stock ○ Available upon Order

D	Tol
D 12	0 -0.02
D > 12	0 -0.03

unit (mm)

Workpiece Material						
P		M	K	N		
1234	5	123	123	123	4	5
Carbon Steel, Alloy Steel (<35 HRC)	Alloy Steel, Tool Steel (<48HRC)	Stainless Steel	Cast Iron	Aluminium Alloys	Copper Alloys	Graphite
⊙	⊙	○	⊙			

⊙ Most Suitable ○ Suitable

Cutting Parameters ※ P429

SP210-CN4

4 Flute, with Variable Helix and Reduced Neck (Chamfered Corner)

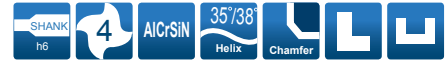
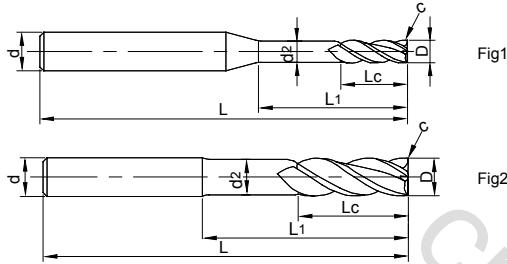

See page 97 for guidelines to icons

Ordering Code	D	Lc	C	d2	L1	L	d	Figure No.	Stock
SP210-CN4-03013	3	10	0.13	2.9	18	75	4	1	○
SP210-CN4-04018	4	12	0.18	3.8	20	75	4	2	●
SP210-CN4-05020	5	15	0.2	4.8	35	75	6	2	○
SP210-CN4-06020	6	16	0.2	5.8	24	100	6	2	●
SP210-CN4-08020	8	20	0.2	7.5	30	100	8	2	○
SP210-CN4-10030	10	25	0.3	9.5	40	150	10	2	○
SP210-CN4-12030	12	30	0.3	11	40	150	12	2	○
SP210-CN4-16040	16	36	0.4	15	50	150	16	2	○
SP210-CN4-20050	20	45	0.5	19	60	150	20	2	○

●Stock ○Available upon Order

D	Tol
D 12	0 -0.02
D > 12	0 -0.03

unit (mm)

Workpiece Material

P		M	K	N		
1234	5	123	123	123	4	5
Carbon Steel, Alloy Steel (<35 HRC)	Alloy Steel, Tool Steel (<48HRC)	Stainless Steel	Cast Iron	Aluminium Alloys	Copper Alloys	Graphite
⊙	⊙	○	⊙			

⊙ Most Suitable ○ Suitable

Cutting Parameters ※ P429

UPR100-S4

4 Flute Square End, with Roughing Geometry

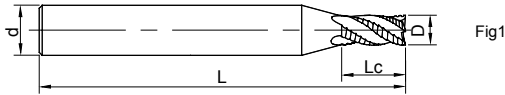

Fig1

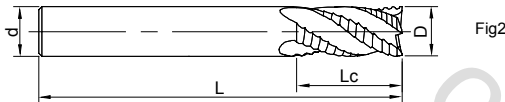

Fig2



See page 97 for guidelines to icons

Ordering Code	D	Lc	L	d	Figure No.	Stock
UPR100-S4-06015	6	15	50	6	2	●
UPR100-S4-08020	8	20	60	8	2	●
UPR100-S4-10025	10	25	75	10	2	●
UPR100-S4-12030	12	30	75	12	2	●
UPR100-S4-14034	14	34	100	14	2	●
UPR100-S4-16036	16	36	100	16	2	●
UPR100-S4-20045	20	45	100	20	2	●

● Stock ○ Available upon Order

D	Tol
D 6	0 -0.03
6 < D 10	0 -0.04
D > 10	0 -0.05

unit (mm)

Workpiece Material						
P		M	K	N		
1234	5	123	123	123	4	5
Carbon Steel, Alloy Steel (<35 HRC)	Alloy Steel, Tool Steel (<48HRC)	Stainless Steel	Cast Iron	Aluminium Alloys	Copper Alloys	Graphite
⊙	⊙	○	⊙	○	○	

⊙ Most Suitable ○ Suitable

Cutting Parameters ※ P431

UPN210-S4

4 Flute Square End, with Roughing Geometry

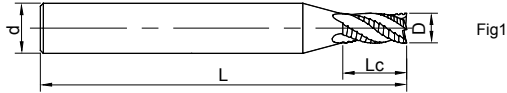

Fig1

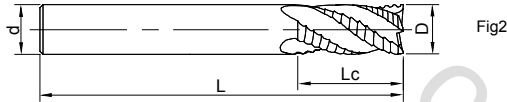

Fig2



See page 97 for guidelines to icons

Ordering Code	D	Lc	L	d	Figure No.	Stock
UPN210-S4-06016	6	16	50	6	2	●
UPN210-S4-08020	8	20	60	8	2	●
UPN210-S4-10025	10	25	75	10	2	●
UPN210-S4-12030	12	30	75	12	2	●
UPN210-S4-16036	16	36	100	16	2	○
UPN210-S4-20045	20	45	100	20	2	○

● Stock ○ Available upon Order

D	Tol
D 6	0 -0.03
6 < D ≤ 10	0 -0.04
D > 10	0 -0.05

unit (mm)

Workpiece Material						
P		M	K	N		
1234	5	123	123	123	4	5
Carbon Steel, Alloy Steel (<35 HRC)	Alloy Steel, Tool Steel (<48HRC)	Stainless Steel	Cast Iron	Aluminium Alloys	Copper Alloys	Graphite
⊙	⊙	○	⊙	○	○	

⊙ Most Suitable ○ Suitable

Cutting Parameters ✕ P433

UPM100-SN2

2 Flute Square End, Miniature Sizes with Neck

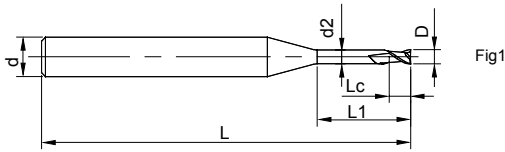
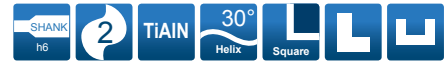

Fig1



See page 97 for guidelines to icons

Ordering Code	D	Lc	d2	L1	L	d	Figure No.	Stock
UPM100-SN2-00802	0.8	1.2	0.75	2	50	4	1	○
UPM100-SN2-00804	0.8	1.2	0.75	4	50	4	1	○
UPM100-SN2-00806	0.8	1.2	0.75	6	50	4	1	○
UPM100-SN2-01006	1.0	1.5	0.95	6	50	4	1	○
UPM100-SN2-01008	1.0	1.5	0.95	8	50	4	1	○
UPM100-SN2-01010	1.0	1.5	0.95	10	50	4	1	●
UPM100-SN2-01508	1.5	2.0	1.44	8	50	4	1	○
UPM100-SN2-01510	1.5	2.0	1.44	10	50	4	1	○
UPM100-SN2-01512	1.5	2.0	1.44	12	50	4	1	●
UPM100-SN2-02008	2.0	3.0	1.92	8	50	4	1	○
UPM100-SN2-02010	2.0	3.0	1.92	10	50	4	1	○
UPM100-SN2-02012	2.0	3.0	1.92	12	50	4	1	●

● Stock ○ Available upon Order

D	Tol
0.8 ≤ D ≤ 2	0 -0.02

unit (mm)

Workpiece Material						
P		M	K	N		
1234	5	123	123	123	4	5
Carbon Steel, Alloy Steel (<35 HRC)	Alloy Steel, Tool Steel (<48HRC)	Stainless Steel	Cast Iron	Aluminium Alloys	Copper Alloys	Graphite
◎	○	○	◎			

◎ Most Suitable ○ Suitable

Cutting Parameters ※ P435

US200-S2

2 Flute, Standard Length

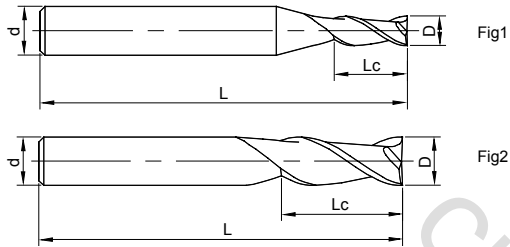

See page 97 for guidelines to icons

Ordering Code	D	Lc	L	d	Figure No.	Stock
US200-S2-00501	0.5	1	50	4	1	●
US200-S2-00802	0.8	2	50	4	1	●
US200-S2-01003	1	3	50	4	1	●
US200-S2-01504	1.5	4	50	4	1	○
US200-S2-02006	2	6	50	4	1	●
US200-S2-02508	2.5	8	50	4	1	●
US200-S2-63008	3	8	50	6	1	●
US200-S2-03009	3	9	50	4	1	●
US200-S2-03510	3.5	10	50	4	1	●

●Stock ○Available upon Order

D	Tol
D ≤ 12	0 -0.02
D > 12	0 -0.03

unit (mm)

Workpiece Material

P		M	K	S	
1234	5	123	123	123	4
Carbon Steel, Alloy Steel (< 35HRC)	Alloy Steel, Tool Steel (<48HRC)	Stainless Steel	Cast Iron	Heat-resistant Alloys	Titanium Alloys
○	○	⊙	○	○	○

⊙ Most Suitable ○ Suitable

Cutting Parameters ※ P437

US200-S2

2 Flute, Standard Length

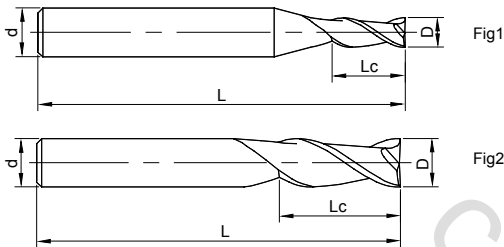

See page 97 for guidelines to icons

» 续前

Ordering Code	D	Lc	L	d	Figure No.	Stock
US200-S2-04011	4	11	50	4	2	●
US200-S2-64011	4	11	50	6	1	●
US200-S2-05013	5	13	50	6	1	●
US200-S2-06016	6	16	50	6	2	●
US200-S2-08020	8	20	60	8	2	●
US200-S2-10025	10	25	75	10	2	●
US200-S2-12030	12	30	75	12	2	●
US200-S2-16036	16	36	100	16	2	○
US200-S2-20045	20	45	100	20	2	●

● Stock ○ Available upon Order

D	Tol
D ≤ 12	0 -0.02
D > 12	0 -0.03

unit (mm)

Workpiece Material

P		M	K	S	
1234	5	123	123	123	4
Carbon Steel, Alloy Steel (< 35HRC)	Alloy Steel, Tool Steel (<48HRC)	Stainless Steel	Cast Iron	Heat-resistant Alloys	Titanium Alloys
○	○	◎	○	○	○

◎ Most Suitable ○ Suitable

Cutting Parameters ※ P437

US200-SS4

4 Flute, Stub Length

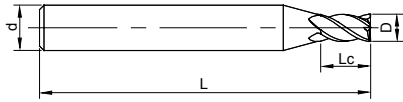

Fig1

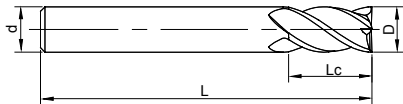

Fig2



See page 97 for guidelines to icons

Ordering Code	D	Lc	L	d	Figure No.	Stock
US200-SS4-02004	2	4	50	4	1	●
US200-SS4-03004	3	4	50	4	1	○
US200-SS4-04006	4	6	50	4	2	○
US200-SS4-05008	5	8	50	6	1	○
US200-SS4-06009	6	9	50	6	2	●
US200-SS4-08010	8	10	60	8	2	●
US200-SS4-10012	10	12	75	10	2	○
US200-SS4-12016	12	16	75	12	2	●
US200-SS4-14020	14	20	75	14	2	○
US200-SS4-16024	16	24	100	16	2	○
US200-SS4-18027	18	27	100	18	2	○
US200-SS4-20030	20	30	100	20	2	○

●Stock ○Available upon Order

D	Tol
D 12	0 -0.02
D > 12	0 -0.03

unit (mm)

Workpiece Material

P		M	K	S	
1234	5	123	123	123	4
Carbon Steel, Alloy Steel (< 35HRC)	Alloy Steel, Tool Steel (<48HRC)	Stainless Steel	Cast Iron	Heat-resistant Alloys	Titanium Alloys
○	○	⊙	○	○	○

⊙ Most Suitable ○ Suitable

Cutting Parameters ※ P438

US200-S4

4 Flute, Standard Length

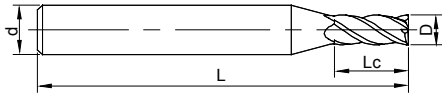

Fig1

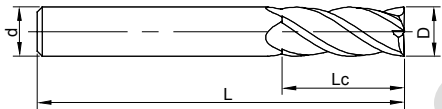

Fig2



See page 97 for guidelines to icons

Ordering Code	D	Lc	L	d	Figure No.	Stock
US200-S4-01003	1	3	50	4	1	●
US200-S4-01504	1.5	4	50	4	1	●
US200-S4-02006	2	6	50	4	1	●
US200-S4-02508	2.5	8	50	4	1	●
US200-S4-63008	3	8	50	6	1	○
US200-S4-03009	3	9	50	4	1	●
US200-S4-03510	3.5	10	50	4	1	●
US200-S4-04011	4	11	50	4	2	●
US200-S4-64011	4	11	50	6	1	●
US200-S4-05013	5	13	50	6	1	●
US200-S4-06016	6	16	50	6	2	●
US200-S4-08020	8	20	60	8	2	●
US200-S4-10025	10	25	75	10	2	●
US200-S4-12030	12	30	75	12	2	●
US200-S4-16036	16	36	100	16	2	○
US200-S4-20045	20	45	100	20	2	●

● Stock ○ Available upon Order

D	Tol
D 12	0 -0.02
D > 12	0 -0.03

unit (mm)

Workpiece Material					
P		M	K	S	
1234	5	123	123	123	4
Carbon Steel, Alloy Steel (< 35HRC)	Alloy Steel, Tool Steel (<48HRC)	Stainless Steel	Cast Iron	Heat-resistant Alloys	Titanium Alloys
○	○	◎	○	○	○

● Most Suitable ○ Suitable

Cutting Parameters ※ P438

US200-SN4

4 Flute, with Reduced Neck Diameter

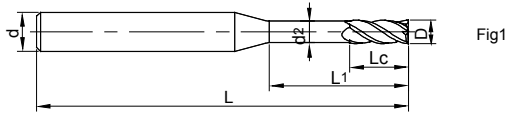

Fig1

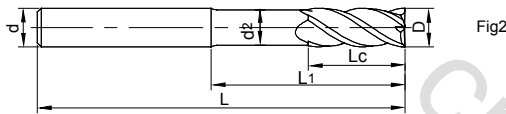

Fig2



See page 97 for guidelines to icons

Ordering Code	D	Lc	d2	L1	L	d	Figure No.	Stock
US200-SN4-02008	2	4	1.9	8	50	4	1	●
US200-SN4-04012	4	8	3.8	12	50	4	2	●
US200-SN4-06018	6	13	5.8	18	50	6	2	○
US200-SN4-08025	8	19	7.5	25	60	8	2	○
US200-SN4-10032	10	22	9.5	32	75	10	2	○
US200-SN4-12034	12	24	11	34	75	12	2	●
US200-SN4-16036	16	26	15	36	100	16	2	○
US200-SN4-20040	20	28	19	40	100	20	2	●

●Stock ○Available upon Order

D	Tol
D 12	0 -0.02
D > 12	0 -0.03

unit (mm)

Workpiece Material

P		M	K	S	
1234	5	123	123	123	4
Carbon Steel, Alloy Steel (< 35HRC)	Alloy Steel, Tool Steel (<48HRC)	Stainless Steel	Cast Iron	Heat-resistant Alloys	Titanium Alloys
○	○	⊙	○	○	○

● Most Suitable ○ Suitable

Cutting Parameters ※ P438

US300-SS4

4 Flute, Stub Length

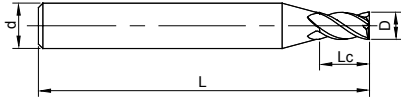

Fig1



Fig2



See page 97 for guidelines to icons

Ordering Code	D	Lc	L	d	Figure No.	Stock
US300-SS4-01002	1	2	50	4	1	●
US300-SS4-01503	1.5	3	50	4	1	●
US300-SS4-02002	2	2	50	4	1	○
US300-SS4-02004	2	4	50	4	1	○
US300-SS4-03003	3	3	50	4	1	●
US300-SS4-03004	3	4	50	4	1	●
US300-SS4-04004	4	4	50	4	2	○
US300-SS4-04006	4	6	50	4	2	●

● Stock ○ Available upon Order

D	Tol
D 12	0 -0.02

unit (mm)

Workpiece Material

P		M	K	S	
1234	5	123	123	123	4
Carbon Steel, Alloy Steel (< 35HRC)	Alloy Steel, Tool Steel (<48HRC)	Stainless Steel	Cast Iron	Heat-resistant Alloys	Titanium Alloys
○	○	⊙	○	○	○

● Most Suitable ○ Suitable

Cutting Parameters ※ P439

US300-S4

4 Flute, Standard Length

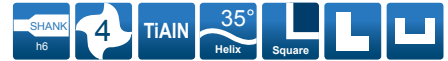
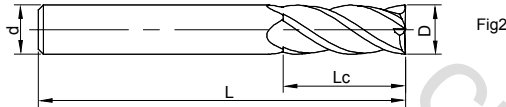
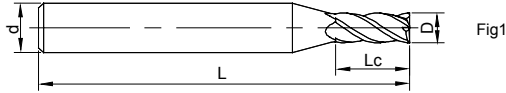

See page 97 for guidelines to icons

Ordering Code	D	Lc	L	d	Figure No.	Stock
US300-S4-01003	1	3	50	4	1	●
US300-S4-01503	1.5	3.5	50	4	1	●
US300-S4-01504	1.5	4	50	4	1	●
US300-S4-02006	2	6	50	4	1	●
US300-S4-02508	2.5	8	50	4	1	●
US300-S4-03009	3	9	50	4	1	●
US300-S4-03510	3.5	10	50	4	1	●
US300-S4-04011	4	11	50	4	2	●
US300-S4-64011	4	11	50	6	1	●
US300-S4-05013	5	13	50	6	1	●
US300-S4-06016	6	16	50	6	2	●
US300-S4-08020	8	20	60	8	2	●
US300-S4-10025	10	25	75	10	2	●
US300-S4-12030	12	30	75	12	2	○

● Stock ○ Available upon Order

D	Tol
D 12	0 -0.02

unit (mm)

Workpiece Material

P		M	K	S	
1234	5	123	123	123	4
Carbon Steel, Alloy Steel (< 35HRC)	Alloy Steel, Tool Steel (<48HRC)	Stainless Steel	Cast Iron	Heat-resistant Alloys	Titanium Alloys
○	○	⊙	○	○	○

● Most Suitable ○ Suitable

Cutting Parameters ※ P439

SS200-CS4

4 Flute, Stub Length with variable Helix

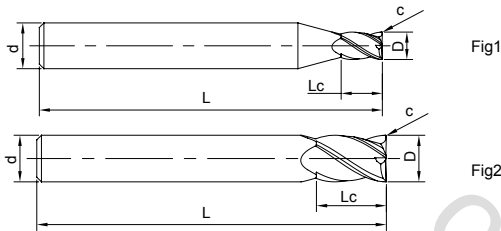

See page 97 for guidelines to icons

Ordering Code	D	Lc	C	L	d	Figure No.	Stock
SS200-CS4-02002	2	4	0.02	50	6	1	●
SS200-CS4-03003	3	6	0.03	50	6	1	○
SS200-CS4-04004	4	8	0.04	50	6	1	●
SS200-CS4-05005	5	9	0.05	50	6	1	●
SS200-CS4-06006	6	10	0.06	50	6	2	●
SS200-CS4-08008	8	12	0.08	60	8	2	○
SS200-CS4-10010	10	14	0.10	75	10	2	○
SS200-CS4-12012	12	16	0.12	75	12	2	●

● Stock ○ Available upon Order

D	Tol
D 12	0 -0.04
unit (mm)	

Workpiece Material

P		M	K	S	
1234	5	123	123	123	4
Carbon Steel, Alloy Steel (< 35HRC)	Alloy Steel, Tool Steel (<48HRC)	Stainless Steel	Cast Iron	Heat-resistant Alloys	Titanium Alloys
○	○	⊙	○	○	○

● Most Suitable ○ Suitable

Cutting Parameters ※ P440

SS200-C4

4 Flute, with Variable Helix

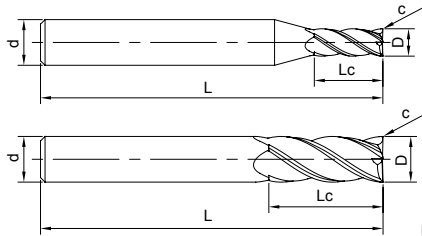
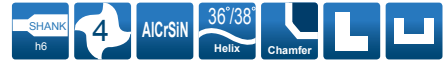

Fig1

Fig2



See page 97 for guidelines to icons

Ordering Code	D	Lc	C	L	d	Figure No.	Stock
SS200-C4-02002	2	6	0.02	50	6	1	●
SS200-C4-03003	3	9	0.03	50	6	1	●
SS200-C4-04004	4	11	0.04	50	6	1	●
SS200-C4-05005	5	13	0.05	50	6	1	●
SS200-C4-06006	6	15	0.06	50	6	2	○
SS200-C4-08008	8	20	0.08	60	8	2	●
SS200-C4-10010	10	25	0.10	75	10	2	○
SS200-C4-12012	12	30	0.12	75	12	2	●

●Stock ○Available upon Order

D	Tol
D 12	0 -0.04

unit (mm)

Workpiece Material

P		M	K	S	
1234	5	123	123	123	4
Carbon Steel, Alloy Steel (< 35HRC)	Alloy Steel, Tool Steel (<48HRC)	Stainless Steel	Cast Iron	Heat-resistant Alloys	Titanium Alloys
○	○	⊙	○	○	○

● Most Suitable ○ Suitable

Cutting Parameters ※ P440

UA100-S2

2 Flute, Standard Length

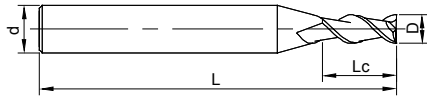

Fig1

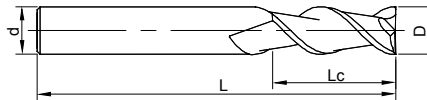
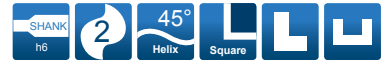

Fig2



See page 97 for guidelines to icons

Ordering Code	D	Lc	L	d	Figure No.	Stock
UA100-S2-01003	1	3	50	4	1	●
UA100-S2-01504	1.5	4	50	4	1	●
UA100-S2-02006	2	6	50	4	1	●
UA100-S2-03009	3	9	50	4	1	●
UA100-S2-63009	3	9	50	6	1	●
UA100-S2-04006	4	6	50	4	2	○
UA100-S2-04011	4	11	50	4	2	●
UA100-S2-64011	4	11	50	6	1	●
UA100-S2-04512	4.5	12	50	6	1	●
UA100-S2-05013	5	13	50	6	1	●
UA100-S2-05516	5.5	16	50	6	1	○

● Stock ○ Available upon Order

D	Tol
D ≤ 12	0 -0.02
D > 12	0 -0.03

unit (mm)

Workpiece Material

P		M	K	N		
1234	5	123	123	123	4	5
Carbon Steel, Alloy Steel (< 35HRC)	Alloy Steel, Tool Steel (< 48HRC)	Stainless Steel	Cast Iron	Aluminium Alloys	Copper Alloys	Graphite
				⊙	⊙	

● Most Suitable ○ Suitable

Cutting Parameters ※ P441

UA100-S2

2 Flute, Standard Length

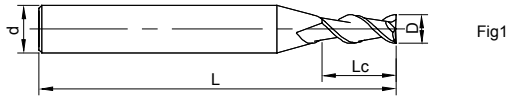

Fig1

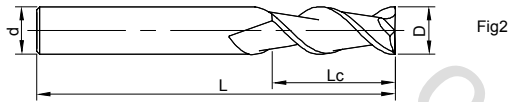
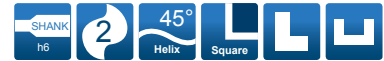

Fig2



See page 97 for guidelines to icons

Ordering Code	D	Lc	L	d	Figure No.	Stock
UA100-S2-06006	6	6	50	6	2	○
UA100-S2-06012	6	12	50	6	2	○
UA100-S2-06016	6	16	50	6	2	●
UA100-S2-07020	7	20	60	8	1	●
UA100-S2-08020	8	20	60	8	2	●
UA100-S2-09023	9	23	75	10	1	●
UA100-S2-10025	10	25	75	10	2	●
UA100-S2-12030	12	30	75	12	2	●
UA100-S2-16036	16	36	100	16	2	●
UA100-S2-20045	20	45	100	20	2	○

●Stock ○Available upon Order

D	Tol
D ≤ 12	0 -0.02
D > 12	0 -0.03

unit (mm)

Workpiece Material

P		M	K	N		
1234	5	123	123	123	4	5
Carbon Steel, Alloy Steel (< 35HRC)	Alloy Steel, Tool Steel (<48HRC)	Stainless Steel	Cast Iron	Aluminium Alloys	Copper Alloys	Graphite
				⊙	⊙	

● Most Suitable ○ Suitable

Cutting Parameters ※ P441

UA100-SL2

2 Flute, Long Flute Length

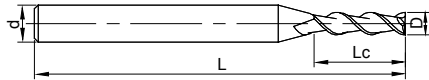

Fig1

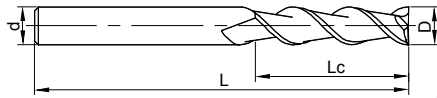

Fig2



See page 97 for guidelines to icons

Ordering Code	D	Lc	L	d	Figure No.	Stock
UA100-SL2-02020	2	20	75	4	1	○
UA100-SL2-03025	3	25	75	4	1	●
UA100-SL2-04030	4	30	75	4	2	●
UA100-SL2-05030	5	30	75	6	1	●
UA100-SL2-06035	6	35	75	6	2	○
UA100-SL2-08040	8	40	100	8	2	●
UA100-SL2-10045	10	45	100	10	2	●
UA100-SL2-12050	12	50	100	12	2	●
UA100-SL2-16060	16	60	150	16	2	○
UA100-SL2-20070	20	70	150	20	2	○

● Stock ○ Available upon Order

D	Tol
D 12	0 -0.02
D > 12	0 -0.03

unit (mm)

Workpiece Material

P		M	K	N		
1234	5	123	123	123	4	5
Carbon Steel, Alloy Steel (< 35HRC)	Alloy Steel, Tool Steel (<48HRC)	Stainless Steel	Cast Iron	Aluminium Alloys	Copper Alloys	Graphite
				⊙	⊙	

● Most Suitable ○ Suitable

Cutting Parameters ※ P441

UA100-SH2

2 Flute, with Long Shank Length

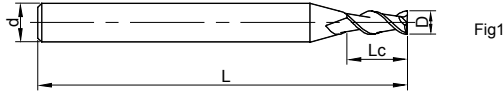

Fig1

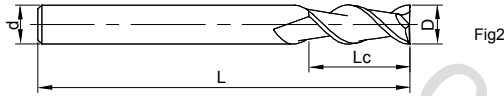
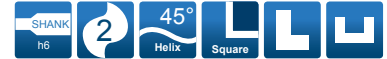

Fig2



See page 97 for guidelines to icons

Ordering Code	D	Lc	L	d	Figure No.	Stock
UA100-SH2-02006	2	6	75	4	1	●
UA100-SH2-03009	3	9	75	4	1	○
UA100-SH2-04010	4	10	75	4	2	●
UA100-SH2-06016	6	16	75	6	2	○
UA100-SH2-08020	8	20	100	8	2	●
UA100-SH2-10025	10	25	100	10	2	●
UA100-SH2-12030	12	30	100	12	2	○
UA100-SH2-16036	16	36	150	16	2	●
UA100-SH2-20045	20	45	150	20	2	●

●Stock ○Available upon Order

D	Tol
D 12	0 -0.02
D > 12	0 -0.03

unit (mm)

Workpiece Material

P		M	K	N		
1234	5	123	123	123	4	5
Carbon Steel, Alloy Steel (< 35HRC)	Alloy Steel, Tool Steel (<48HRC)	Stainless Steel	Cast Iron	Aluminium Alloys	Copper Alloys	Graphite
				⊙	⊙	

● Most Suitable ○ Suitable

Cutting Parameters ※ P441

UA100-S3

3 Flute, Standard Length

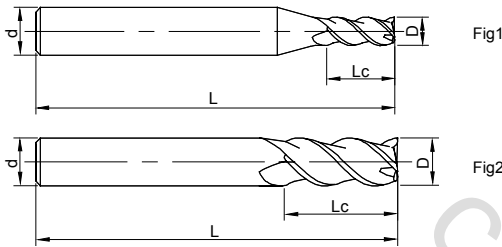

See page 97 for guidelines to icons

Ordering Code	D	Lc	L	d	Figure No.	Stock
UA100-S3-01003	1	3	50	4	1	●
UA100-S3-01504	1.5	4	50	4	1	○
UA100-S3-02006	2	6	50	4	1	○
UA100-S3-02508	2.5	8	50	4	1	○
UA100-S3-03009	3	9	50	4	1	○
UA100-S3-04011	4	11	50	4	2	○
UA100-S3-64011	4	11	50	6	1	○
UA100-S3-05013	5	13	50	6	1	●
UA100-S3-06012	6	12	50	6	2	○

● Stock ○ Available upon Order

D	Tol
D ≤ 12	0 -0.02
D > 12	0 -0.03

unit (mm)

Workpiece Material

P		M	K	N		
1234	5	123	123	123	4	5
Carbon Steel, Alloy Steel (< 35HRC)	Alloy Steel, Tool Steel (< 48HRC)	Stainless Steel	Cast Iron	Aluminium Alloys	Copper Alloys	Graphite
				⊙	⊙	

● Most Suitable ○ Suitable

Cutting Parameters ※ P442

UA100-S3

3 Flute, Standard Length

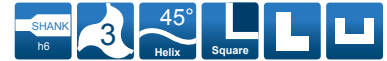
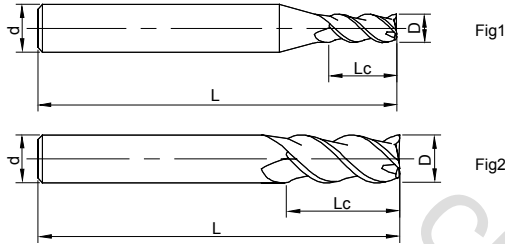

See page 97 for guidelines to icons

Ordering Code	D	Lc	L	d	Figure No.	Stock
UA100-S3-06016	6	16	50	6	2	○
UA100-S3-07020	7	20	60	8	1	○
UA100-S3-08020	8	20	60	8	2	○
UA100-S3-09023	9	23	75	10	1	●
UA100-S3-10025	10	25	75	10	2	○
UA100-S3-12030	12	30	75	12	2	○
UA100-S3-16036	16	36	100	16	2	○
UA100-S3-18038	18	38	100	18	2	○
UA100-S3-20045	20	45	100	20	2	○

●Stock ○Available upon Order

D	Tol
D 12	0 -0.02
D > 12	0 -0.03

unit (mm)

Workpiece Material

P		M	K	N		
1234	5	123	123	123	4	5
Carbon Steel, Alloy Steel (< 35HRC)	Alloy Steel, Tool Steel (< 48HRC)	Stainless Steel	Cast Iron	Aluminium Alloys	Copper Alloys	Graphite
				⊙	⊙	

● Most Suitable ○ Suitable

Cutting Parameters ※ P442

UA100-SL3

3 Flute, Long Flute Length

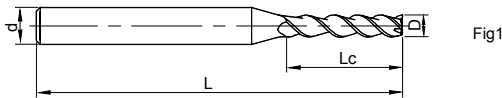

Fig1

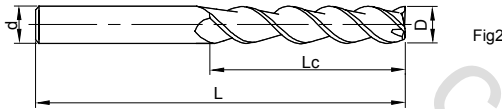
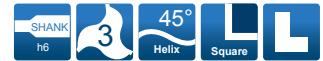

Fig2



See page 97 for guidelines to icons

Ordering Code	D	Lc	L	d	Figure No.	Stock
UA100-SL3-02020	2	20	75	4	1	●
UA100-SL3-03025	3	25	75	4	1	●
UA100-SL3-04030	4	30	75	4	2	●
UA100-SL3-05030	5	30	75	6	1	○
UA100-SL3-06035	6	35	75	6	2	●
UA100-SL3-08040	8	40	100	8	2	●
UA100-SL3-10045	10	45	100	10	2	●
UA100-SL3-12050	12	50	100	12	2	●
UA100-SL3-16060	16	60	150	16	2	●
UA100-SL3-20070	20	70	150	20	2	●

● Stock ○ Available upon Order

D	Tol
D 12	0 -0.02
D > 12	0 -0.03

unit (mm)

Workpiece Material

P		M	K	N		
1234	5	123	123	123	4	5
Carbon Steel, Alloy Steel (< 35HRC)	Alloy Steel, Tool Steel (<48HRC)	Stainless Steel	Cast Iron	Aluminium Alloys	Copper Alloys	Graphite
				⊙	⊙	

● Most Suitable ○ Suitable

Cutting Parameters ※ P442

UA100-SH3

3 Flute, with Long Shank Length

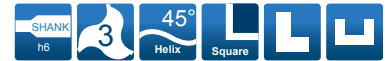
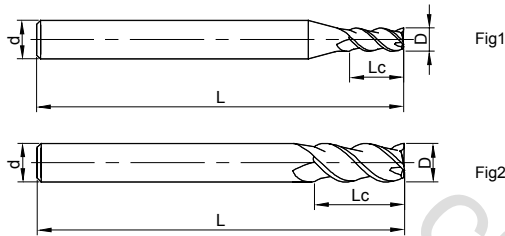

See page 97 for guidelines to icons

Ordering Code	D	Lc	L	d	Figure No.	Stock
UA100-SH3-02008	2	8	75	4	1	○
UA100-SH3-03010	3	10	75	4	1	●
UA100-SH3-04012	4	12	75	4	2	●
UA100-SH3-06016	6	16	75	6	2	●
UA100-SH3-08020	8	20	100	8	2	●
UA100-SH3-10025	10	25	100	10	2	●
UA100-SH3-12030	12	30	100	12	2	●
UA100-SH3-16036	16	36	150	16	2	●
UA100-SH3-20045	20	45	150	20	2	○

●Stock ○Available upon Order

D	Tol
D 12	0 -0.02
D > 12	0 -0.03

unit (mm)

Workpiece Material

P		M	K	N		
1234	5	123	123	123	4	5
Carbon Steel, Alloy Steel (< 35HRC)	Alloy Steel, Tool Steel (<48HRC)	Stainless Steel	Cast Iron	Aluminium Alloys	Copper Alloys	Graphite
				⊙	⊙	

● Most Suitable ○ Suitable

Cutting Parameters ※ P442

UA160-S2

2 Flute, Standard Length

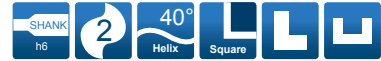
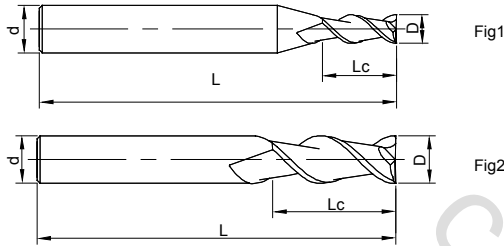

See page 97 for guidelines to icons

Ordering Code	D	Lc	L	d	Figure No.	Stock
UA160-S2-01003	1	3	50	4	1	●
UA160-S2-01504	1.5	4	50	4	1	●
UA160-S2-02006	2	6	50	4	1	●
UA160-S2-02508	2.5	8	50	4	1	○
UA160-S2-03009	3	9	50	4	1	●
UA160-S2-04011	4	11	50	4	2	●
UA160-S2-05013	5	13	50	6	1	●
UA160-S2-06016	6	16	50	6	2	●
UA160-S2-08020	8	20	60	8	2	●
UA160-S2-10025	10	25	75	10	2	○
UA160-S2-12030	12	30	75	12	2	●

● Stock ○ Available upon Order

D	Tol
D ≤ 10	0 -0.01
D > 10	0 -0.02

unit (mm)

Workpiece Material

P		M	K	N		
1234	5	123	123	123	4	5
Carbon Steel, Alloy Steel (< 35HRC)	Alloy Steel, Tool Steel (< 48HRC)	Stainless Steel	Cast Iron	Aluminium Alloys	Copper Alloys	Graphite
				⊙	⊙	

● Most Suitable ○ Suitable

Cutting Parameters ※ P443

UA160-S3

3 Flute, Standard Length

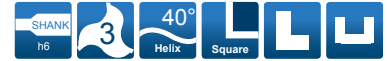
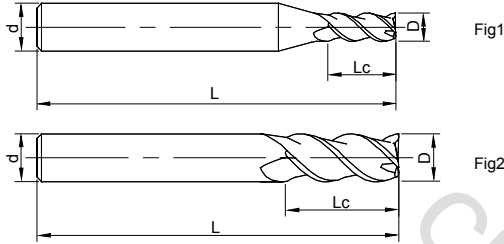

See page 97 for guidelines to icons

Ordering Code	D	Lc	L	d	Figure No.	Stock
UA160-S3-02006	2	6	50	4	1	●
UA160-S3-02508	2.5	8	50	4	1	○
UA160-S3-03009	3	9	50	4	1	●
UA160-S3-04011	4	11	50	4	2	●
UA160-S3-64011	4	11	50	6	1	○
UA160-S3-05013	5	13	50	6	1	●
UA160-S3-06016	6	16	50	6	2	●
UA160-S3-08020	8	20	60	8	2	●
UA160-S3-10025	10	25	75	10	2	●
UA160-S3-12030	12	30	75	12	2	●

●Stock ○Available upon Order

D	Tol
D ≤ 10	0 -0.01
D > 10	0 -0.02

unit (mm)

Workpiece Material

P		M	K	N		
1234	5	123	123	123	4	5
Carbon Steel, Alloy Steel (< 35HRC)	Alloy Steel, Tool Steel (<48HRC)	Stainless Steel	Cast Iron	Aluminium Alloys	Copper Alloys	Graphite
				⊙	⊙	

● Most Suitable ○ Suitable

Cutting Parameters ※ P444

UA160-S4

4 Flute, Standard Length

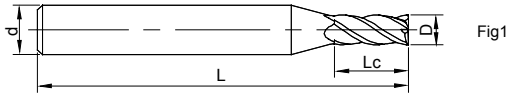

Fig1

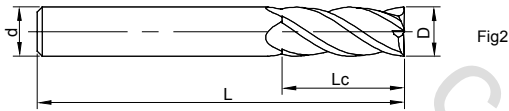
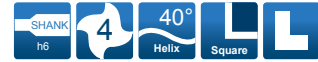

Fig2



See page 97 for guidelines to icons

Ordering Code	D	Lc	L	d	Figure No.	Stock
UA160-S4-04011	4	11	50	4	1	○
UA160-S4-06016	6	16	50	6	1	●
UA160-S4-08020	8	20	60	8	1	●
UA160-S4-10025	10	25	75	10	1	○
UA160-S4-12030	12	30	75	12	1	○

● Stock ○ Available upon Order

D	Tol
D 10	0 -0.01
D > 10	0 -0.02

unit (mm)

Workpiece Material

P		M	K	N		
1234	5	123	123	123	4	5
Carbon Steel, Alloy Steel (< 35HRC)	Alloy Steel, Tool Steel (<48HRC)	Stainless Steel	Cast Iron	Aluminium Alloys	Copper Alloys	Graphite
				⊙	⊙	

● Most Suitable ○ Suitable

Cutting Parameters ※ P444

SA100-S3 NEW

3 Flute, Standard Length

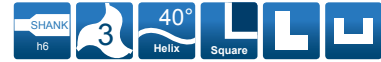
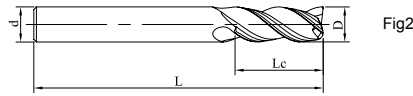
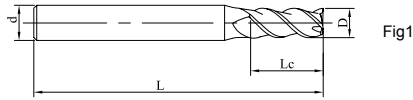

See page 97 for guidelines to icons

Ordering Code	D	Lc	L	d	Figure No.	Stock
SA100-S3-03009	3	9	50	6	1	●
SA100-S3-04011	4	11	50	6	1	●
SA100-S3-05013	5	13	50	6	1	●
SA100-S3-06012	6	12	50	6	2	○
SA100-S3-06016	6	16	50	6	2	●
SA100-S3-08020	8	20	60	8	2	●
SA100-S3-10025	10	25	75	10	2	●
SA100-S3-12030	12	30	75	12	2	●

●Stock ○Available upon Order

D	Tol
D ≤ 10	0 -0.01
D > 10	0 -0.02

unit (mm)

Workpiece Material

P		M	K	N		
1234	5	123	123	123	4	5
Carbon Steel, Alloy Steel (< 35HRC)	Alloy Steel, Tool Steel (<48HRC)	Stainless Steel	Cast Iron	Aluminium Alloys	Copper Alloys	Graphite
				⊙	⊙	

● Most Suitable ○ Suitable

Cutting Parameters ※ P445

SG200-S2

2 Flute, Standard Length

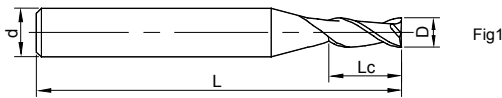

Fig1

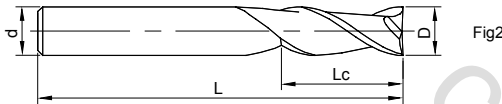

Fig2



See page 97 for guidelines to icons

Ordering Code	D	Lc	L	d	Figure No.	Stock
SG200-S2-00401	0.4	0.8	50	4	1	○
SG200-S2-00802	0.8	2	50	4	1	○
SG200-S2-01003	1	3	50	4	1	●
SG200-S2-01504	1.5	4	50	4	1	○
SG200-S2-02006	2	6	50	4	1	○
SG200-S2-03009	3	9	50	4	1	○
SG200-S2-63009	3	9	50	6	1	○
SG200-S2-04011	4	11	50	4	2	●
SG200-S2-64011	4	11	50	6	1	○
SG200-S2-05013	5	13	50	6	1	○
SG200-S2-06016	6	16	50	6	2	●
SG200-S2-08020	8	20	60	8	2	●
SG200-S2-10025	10	25	75	10	2	○
SG200-S2-12030	12	30	75	12	2	○

● Stock ○ Available upon Order

D	Tol
D < 6	0 -0.02
6 D 12	0 -0.03

unit (mm)

Workpiece Material						
P		M	K	N		
1234	5	123	123	123	4	5
Carbon Steel, Alloy Steel (< 35HRC)	Alloy Steel, Tool Steel (<48HRC)	Stainless Steel	Cast Iron	Aluminium Alloys	Copper Alloys	Graphite
				○	○	◎

● Most Suitable ○ Suitable

Cutting Parameters ※ P449

SG200-S3

3 Flute, Standard Length

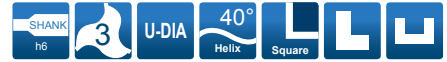
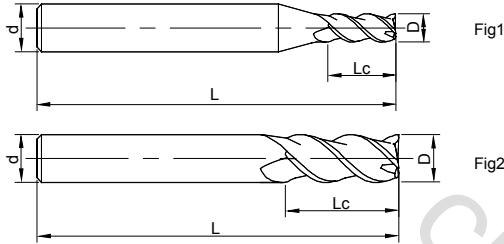

See page 97 for guidelines to icons

Ordering Code	D	Lc	L	d	Figure No.	Stock
SG200-S3-01003	1	3	50	4	1	○
SG200-S3-01504	1.5	4	50	4	1	●
SG200-S3-02006	2	6	50	4	1	○
SG200-S3-03009	3	9	50	4	1	●
SG200-S3-63009	3	9	50	6	1	○
SG200-S3-04011	4	11	50	4	2	○
SG200-S3-64011	4	11	50	6	1	○
SG200-S3-05013	5	13	50	6	1	○
SG200-S3-06016	6	16	50	6	2	○
SG200-S3-08020	8	20	60	8	2	○
SG200-S3-10025	10	25	75	10	2	○
SG200-S3-12030	12	30	75	12	2	○

● Stock ○ Available upon Order

D	Tol
D < 6	0 -0.02
6 D 12	0 -0.03

unit (mm)

Workpiece Material

P		M	K	N		
1234	5	123	123	123	4	5
Carbon Steel, Alloy Steel (< 35HRC)	Alloy Steel, Tool Steel (35-48HRC)	Stainless Steel	Cast Iron	Aluminium Alloys	Copper Alloys	Graphite
				○	○	◎

◎ Most Suitable ○ Suitable

Cutting Parameters ※ P449

SG200-S4

4 Flute, Standard Length

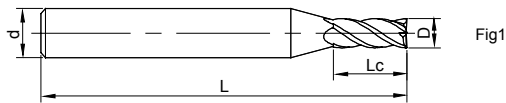

Fig1

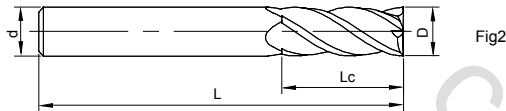

Fig2



See page 97 for guidelines to icons

Ordering Code	D	Lc	L	d	Figure No.	Stock
SG200-S4-02006	2	6	50	4	1	●
SG200-S4-03009	3	9	50	4	1	●
SG200-S4-63009	3	9	50	6	1	○
SG200-S4-04011	4	11	50	4	2	○
SG200-S4-64011	4	11	50	6	1	●
SG200-S4-05013	5	13	50	6	1	○
SG200-S4-06016	6	16	50	6	2	○
SG200-S4-08020	8	20	60	8	2	○
SG200-S4-10025	10	25	75	10	2	●
SG200-S4-12030	12	30	75	12	2	○

● Stock ○ Available upon Order

D	Tol
D < 6	0 -0.02
6 ≤ D ≤ 12	0 -0.03

unit (mm)

Workpiece Material						
P		M	K	N		
1234	5	123	123	123	4	5
Carbon Steel, Alloy Steel (< 35HRC)	Alloy Steel, Tool Steel (35-48HRC)	Stainless Steel	Cast Iron	Aluminium Alloys	Copper Alloys	Graphite
				○	○	◎

● Most Suitable ○ Suitable

Cutting Parameters ※ P449

SG200-SN2

2 Flute Square, with Reduced Neck

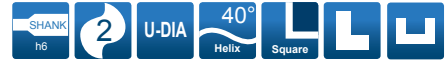
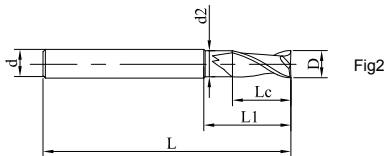
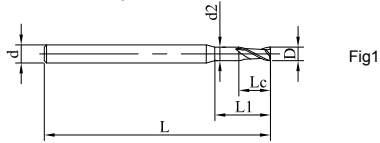

See page 97 for guidelines to icons

Ordering Code	D	Lc	d2	L1	L	d	Figure No.	Stock
SG200-SN2-01005	1	3	0.95	5	50	4	1	○
SG200-SN2-01510	1.5	6	1.44	10	50	4	1	○
SG200-SN2-02015	2	8	1.92	15	50	4	1	●
SG200-SN2-02020	2	8	1.92	20	50	4	1	○
SG200-SN2-03015	3	12	2.9	15	50	4	1	○
SG200-SN2-04020	4	16	3.9	20	50	4	2	○
SG200-SN2-04025	4	16	3.9	25	75	4	2	○
SG200-SN2-04040	4	16	3.9	40	75	4	2	○
SG200-SN2-05030	5	20	4.9	30	75	6	1	○
SG200-SN2-06030	6	24	5.9	30	75	6	2	●
SG200-SN2-06040	6	24	5.9	40	75	6	2	○
SG200-SN2-08040	8	25	7.9	40	100	8	2	○
SG200-SN2-10040	10	25	9.8	40	100	10	2	●
SG200-SN2-12040	12	25	11.8	40	100	12	2	○
SG200-SN2-12060	12	25	11.8	60	100	12	2	○

●Stock ○Available upon Order

D	Tol
D < 6	0 -0.02
6 D 12	0 -0.03

unit (mm)

Workpiece Material						
P		M	K	N		
1234	5	123	123	123	4	5
Carbon Steel, Alloy Steel (< 35HRC)	Alloy Steel, Tool Steel(35-48HRC)	Stainless Steel	Cast Iron	Aluminium Alloys	Copper Alloys	Graphite
				○	○	◎

◎ Most Suitable ○ Suitable

Cutting Parameters ※ P449

ST200-S4

4 Flutewith variable Helix

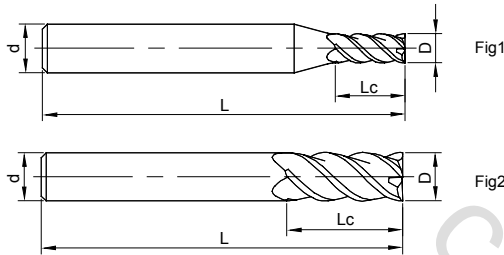

See page 97 for guidelines to icons

Ordering Code	D	Lc	L	d	Figure No.	Stock
ST200-S4-02006	2	6	50	4	1	○
ST200-S4-03006	3	6	50	4	1	○
ST200-S4-04010	4	10	50	4	2	●
ST200-S4-05010	5	10	50	6	1	○
ST200-S4-06015	6	15	50	6	2	●
ST200-S4-08020	8	20	60	8	2	●
ST200-S4-10025	10	25	75	10	2	●
ST200-S4-12030	12	30	75	12	2	●
ST200-S4-16036	16	36	100	16	2	●
ST200-S4-20045	20	45	100	20	2	●

● Stock ○ Available upon Order

D	Tol
D<6	0 -0.02
6 D 16	0 -0.03
D>16	0 -0.04

unit (mm)

Workpiece Material				
P		M	S	
1 2 3 4	5	1 2 3	1 2 3	4
Carbon Steel, Alloy Steel (< 35HRC)	Alloy Steel, Tool Steel (35-48HRC)	Stainless Steel	Heat-resistant Alloys	Titanium Alloys
○	○	○	○	⊙

● Most Suitable ○ Suitable

Cutting Parameters ※ P454

SH160-S2

2 Flute, Standard Length

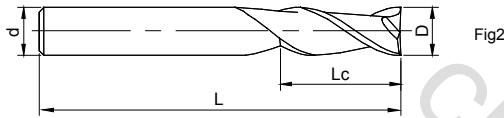
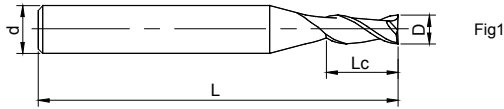

See page 97 for guidelines to icons

Ordering Code	D	Lc	L	d	Figure No.	Stock
SH160-S2-00501	0.5	1.5	50	4	1	●
SH160-S2-01003	1	3	50	4	1	●
SH160-S2-01504	1.5	4	50	4	1	●
SH160-S2-02006	2	6	50	4	1	●
SH160-S2-02508	2.5	8	50	4	1	○
SH160-S2-03009	3	9	50	4	1	●
SH160-S2-63009	3	9	50	6	1	●
SH160-S2-04010	4	10	50	4	2	●
SH160-S2-64010	4	10	50	6	1	●
SH160-S2-05013	5	13	50	6	1	●
SH160-S2-06015	6	15	50	6	2	●

● Stock ○ Available upon Order

D	Tol
D 12	0 -0.02
D > 12	0 -0.03

unit (mm)

WorkpieceMaterial					
P			H		
1	2	3	4	5	6
Carbon Steel, Alloy Steel (< 35HRC)	Alloy Steel (35-48HRC)	PH, Ferrite, Martensite Steel (< 35HRC)	Hardened Steel (45-55HRC)	Hardened Steel (55-60HRC)	Hardened Steel (> 60HRC)
			⊙		

● Most Suitable ○ Suitable

Cutting Parameters ※ P460

SH160-S2

2 Flute, Standard Length

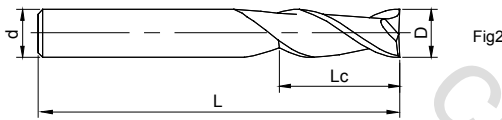
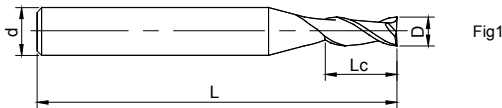

See page 97 for guidelines to icons

» continue

Ordering Code	D	Lc	L	d	Figure No.	Stock
SH160-S2-07020	7	20	60	8	1	○
SH160-S2-08020	8	20	60	8	2	●
SH160-S2-09023	9	23	75	10	1	○
SH160-S2-10025	10	25	75	10	2	●
SH160-S2-11028	11	28	75	12	1	○
SH160-S2-12030	12	30	75	12	2	●
SH160-S2-13032	13	32	100	14	1	○
SH160-S2-14034	14	34	100	14	2	○
SH160-S2-16036	16	36	100	16	2	●
SH160-S2-18040	18	40	100	18	2	○
SH160-S2-20045	20	45	100	20	2	●

●Stock ○Available upon Order

D	Tol
D 12	0 -0.02
D > 12	0 -0.03

unit (mm)

WorkpieceMaterial

P			H		
1	2	3	4	5	6
Carbon Steel, Alloy Steel (< 35HRC)	Alloy Steel (35-48HRC)	PH, Ferrite, Martensite Steel (< 35HRC)	Hardened Steel (45-55HRC)	Hardened Steel (55-60HRC)	Hardened Steel (> 60HRC)
			⊙		

● Most Suitable ○ Suitable

Cutting Parameters ※ P460

SH160-S4

4 Flute, Standard Length

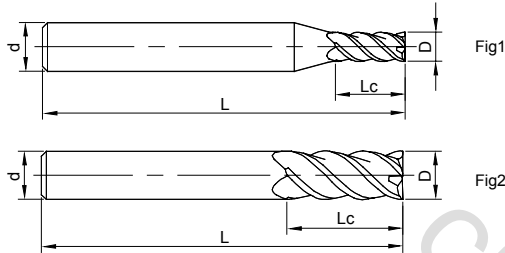

See page 97 for guidelines to icons

Ordering Code	D	Lc	L	d	Figure No.	Stock
SH160-S4-01003	1	3	50	4	1	●
SH160-S4-01504	1.5	4	50	4	1	●
SH160-S4-02006	2	6	50	4	1	●
SH160-S4-02508	2.5	8	50	4	1	●
SH160-S4-03009	3	9	50	4	1	●
SH160-S4-63009	3	9	50	6	1	●
SH160-S4-04010	4	10	50	4	2	●
SH160-S4-64010	4	10	50	6	1	●
SH160-S4-05013	5	13	50	6	1	●
SH160-S4-06015	6	15	50	6	2	○
SH160-S4-08020	8	20	60	8	2	●
SH160-S4-09023	9	23	75	10	1	○

● Stock ○ Available upon Order

D	Tol
D 12	0 -0.02
D > 12	0 -0.03

unit (mm)

Workpiece Material

P			H		
1	2	3	4	5	6
Carbon Steel, Alloy Steel (< 35HRC)	Alloy Steel (35-48HRC)	PH, Ferrite, MartensiteSteel (< 35HRC)	Hardened Steel (45-55HRC)	Hardened Steel (55-60HRC)	Hardened Steel (> 60HRC)
			⊙		

● Most Suitable ○ Suitable

Cutting Parameters ※ P460

SH160-S4

4 Flute, Standard Length

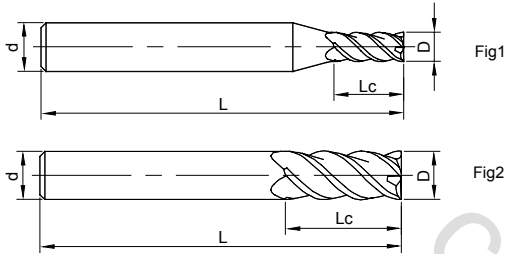

See page 97 for guidelines to icons

» continue

Ordering Code	D	Lc	L	d	Figure No.	Stock
SH160-S4-10025	10	25	75	10	2	●
SH160-S4-12030	12	30	75	12	2	●
SH160-S4-16036	16	36	100	16	2	●
SH160-S4-20045	20	45	100	20	2	●

● Stock ○ Available upon Order

D	Tol
D 12	$\begin{matrix} 0 \\ -0.02 \end{matrix}$
D > 12	$\begin{matrix} 0 \\ -0.03 \end{matrix}$

unit (mm)

Workpiece Material					
P			H		
1	2	3	4	5	6
Carbon Steel, Alloy Steel (< 35HRC)	Alloy Steel (35-48HRC)	PH, Ferrite, Martensite Steel (< 35HRC)	Hardened Steel (45-55HRC)	Hardened Steel (55-60HRC)	Hardened Steel (> 60HRC)
			⊙		

● Most Suitable ○ Suitable

Cutting Parameters ※ P460

SH160-SH4

4 Flute, with Long Shank Length

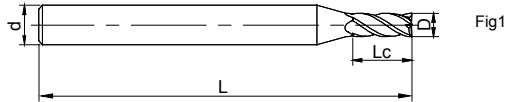

Fig1

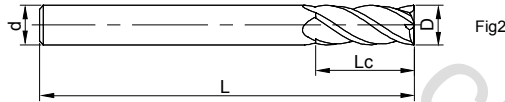

Fig2



See page 97 for guidelines to icons

Ordering Code	D	Lc	L	d	Figure No.	Stock
SH160-SH4-03012	3	12	75	4	1	●
SH160-SH4-04015	4	15	75	4	2	●
SH160-SH4-06020	6	20	100	6	2	○
SH160-SH4-08025	8	25	100	8	2	●
SH160-SH4-10030	10	30	100	10	2	●
SH160-SH4-12035	12	35	100	12	2	●

●Stock ○Available upon Order

D	Tol
D 12	0 -0.02
D > 12	0 -0.03

unit(mm)

Workpiece Material					
P			H		
1	2	3	4	5	6
Carbon Steel, Alloy Steel (< 35HRC)	Alloy Steel (35-48HRC)	PH, Ferrite, MartensiteSteel (< 35HRC)	Hardened Steel (45-55HRC)	Hardened Steel (55-60HRC)	Hardened Steel (> 60HRC)
			⊙		

● Most Suitable ○ Suitable

Cutting Parameters ※ P460

SH160-S6

6 Flute, Standard Length

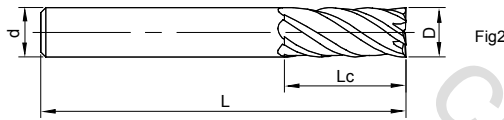
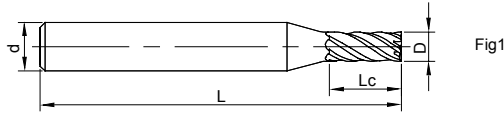

See page 97 for guidelines to icons

Ordering Code	D	Lc	L	d	Figure No.	Stock
SH160-S6-06015	6	15	50	6	2	●
SH160-S6-08020	8	20	60	8	2	●
SH160-S6-10025	10	25	75	10	2	○
SH160-S6-12030	12	30	75	12	2	○
SH160-S6-16036	16	36	100	16	2	●
SH160-S6-20045	20	45	100	20	2	○

● Stock ○ Available upon Order

D	Tol
D 12	⁰ _{-0.02}
D > 12	⁰ _{-0.03}

unit(mm)

Workpiece Material

P			H		
1	2	3	4	5	6
Carbon Steel, Alloy Steel (< 35HRC)	Alloy Steel (35-48HRC)	PH, Ferrite, MartensiteSteel (< 35HRC)	Hardened Steel (45-55HRC)	Hardened Steel (55-60HRC)	Hardened Steel (> 60HRC)
			⊙		

● Most Suitable ○ Suitable

Cutting Parameters ※ P460

SH200-S4-H

4 Flute, Standard Length

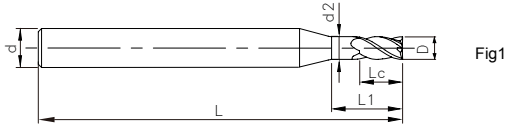

Fig1

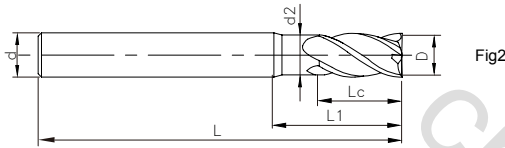

Fig2



See page 97 for guidelines to icons

Ordering Code	D	Lc	d2	L1	L	d	Figure No.	Stock
SH200-S4-01003U-H	1	3	-	-	50	3	1	●
SH200-S4-01003-H	1	2	0.96	3	50	4	1	●
SH200-S4-61003-H	1	2	0.96	3	50	6	1	●
SH200-S4-01505-H	1.5	3	1.44	4.5	50	4	1	●
SH200-S4-61505-H	1.5	3	1.44	4.5	50	6	1	●
SH200-S4-02006-H	2	4	1.92	6	50	4	1	●
SH200-S4-62006-H	2	4	1.92	6	50	6	1	●
SH200-S4-62006U-H	2	6	-	-	50	6	1	○
SH200-S4-02508-H	2.5	5	2.4	7.5	50	4	1	○
SH200-S4-62508-H	2.5	5	2.4	7.5	50	6	1	○
SH200-S4-03009-H	3	6	2.88	9	50	4	1	●

●Stock ○Available upon Order

D	Tol
D 6	0 -0.015
6 < D 12	0 -0.02
D > 12	0 -0.03

unit(mm)

Workpiece Material

P			H		
1	2	3	4	5	6
Carbon Steel, Alloy Steel (< 35HRC)	Alloy Steel (35-48HRC)	PH, Ferrite, MartensiteSteel (< 35HRC)	Hardened Steel (45-55HRC)	Hardened Steel (55-60HRC)	Hardened Steel (> 60HRC)
○	◎		◎	○	

◎ Most Suitable ○ Suitable

Cutting Parameters ※ P462

SH200-S4-H

4 Flute, Standard Length

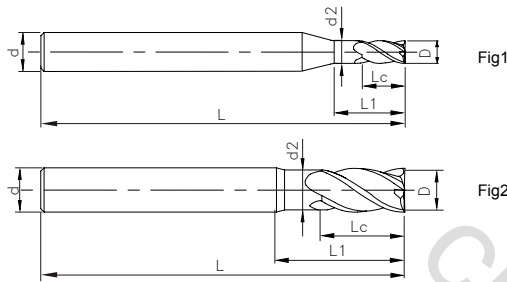

See page 97 for guidelines to icons

» continue

Ordering Code	D	Lc	d2	L1	L	d	Figure No.	Stock
SH200-S4-63009-H	3	6	2.88	9	50	6	1	●
SH200-S4-04012-H	4	8	3.85	12	50	4	2	●
SH200-S4-64012-H	4	8	3.85	12	50	6	1	●
SH200-S4-05015-H	5	10	4.8	15	50	6	1	●
SH200-S4-06018-H	6	12	5.8	18	50	6	2	●
SH200-S4-08024-H	8	16	7.8	24	60	8	2	●
SH200-S4-10030-H	10	20	9.8	30	75	10	2	●
SH200-S4-12036-H	12	24	11.8	36	75	12	2	●
SH200-S4-16032U-H	16	32	-	-	100	16	2	●
SH200-S4-16045U-H	16	45	-	-	100	16	2	○
SH200-S4-20040U-H	20	40	-	-	100	20	2	○

● Stock ○ Available upon Order

D	Tol
D 6	0 -0.015
6 < D 12	0 -0.02
D > 12	0 -0.03

unit(mm)

Workpiece Material

P			H		
1 2 3 4	5	6	1	2	3 4
Carbon Steel, Alloy Steel (< 35HRC)	Alloy Steel (35-48HRC)	PH, Ferrite, MartensiteSteel (< 35HRC)	Hardened Steel (45-55HRC)	Hardened Steel (55-60HRC)	Hardened Steel (> 60HRC)
○	◎		◎	○	

◎ Most Suitable ○ Suitable

Cutting Parameters ※ P462

SH200-SH4-H

4 Flute, with Long Shank Length

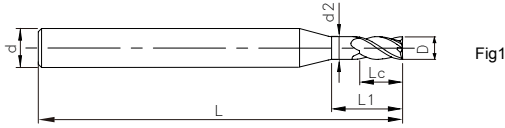

Fig1

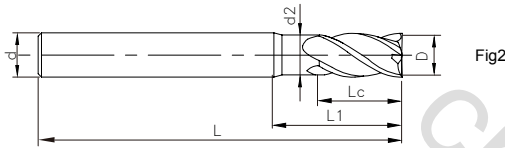

Fig2



See page 97 for guidelines to icons

Ordering Code	D	Lc	d2	L1	L	d	Figure No.	Stock
SH200-SH4-01003-H	1	2	0.96	3	60	4	1	○
SH200-SH4-61003-H	1	2	0.96	3	60	6	1	○
SH200-SH4-61004-H	1	2	0.96	3.5	60	6	1	○
SH200-SH4-01505-H	1.5	3	1.44	4.5	60	4	1	○
SH200-SH4-61504-H	1.5	3	1.44	4.5	60	6	1	○
SH200-SH4-02006-H	2	4	1.92	6	60	4	1	○
SH200-SH4-62006-H	2	4	1.92	6	60	6	1	○
SH200-SH4-02508-H	2.5	5	2.4	7.5	60	4	1	○
SH200-SH4-62508-H	2.5	5	2.4	7.5	60	6	1	○
SH200-SH4-03009-H	3	6	2.88	9	60	4	1	○

●Stock ○Available upon Order

D	Tol
D ≤ 6	0 -0.015
6 < D ≤ 12	0 -0.02
D > 12	0 -0.03

unit(mm)

Workpiece Material					
P			H		
1	2	3	4	5	6
Carbon Steel, Alloy Steel (< 35HRC)	Alloy Steel (35-48HRC)	PH, Ferrite, MartensiteSteel (< 35HRC)	Hardened Steel (45-55HRC)	Hardened Steel (55-60HRC)	Hardened Steel (> 60HRC)
○	◎		◎	○	

● Most Suitable ○ Suitable

Cutting Parameters ※ P462

SH200-SH4-H

4 Flute, with Long Shank Length

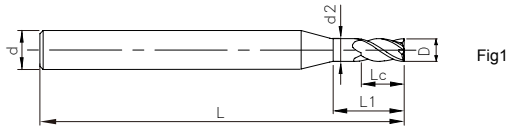

Fig1

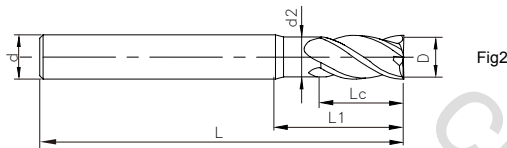

Fig2



See page 97 for guidelines to icons

» continue

Ordering Code	D	Lc	d2	L1	L	d	Figure No.	Stock
SH200-SH4-63009-H	3	6	2.88	9	60	6	1	○
SH200-SH4-04012-H	4	8	3.85	12	60	4	2	○
SH200-SH4-64012-H	4	8	3.85	12	60	6	1	●
SH200-SH4-05015-H	5	10	4.8	15	60	6	1	○
SH200-SH4-06018-H	6	12	5.8	18	60	6	2	●
SH200-SH4-06012U-H	6	12	-	-	75	6	2	●
SH200-SH4-08024-H	8	16	7.8	24	75	8	2	●
SH200-SH4-08016U-H	8	16	-	-	75	8	2	●
SH200-SH4-10030-H	10	20	9.8	30	100	10	2	●
SH200-SH4-12036-H	12	24	11.8	36	100	12	2	●

● Stock ○ Available upon Order

D	Tol
D 6	0 -0.015
6 < D 12	0 -0.02
D > 12	0 -0.03

unit(mm)

Workpiece Material

P			H		
1 2 3 4	5	6	1	2	3 4
Carbon Steel, Alloy Steel (< 35HRC)	Alloy Steel (35-48HRC)	PH, Ferrite, MartensiteSteel (< 35HRC)	Hardened Steel (45-55HRC)	Hardened Steel (55-60HRC)	Hardened Steel (> 60HRC)
○	◎		◎	○	

◎ Most Suitable ○ Suitable

Cutting Parameters ※ P462

SH200-SN4-H

4 Flute, with Reduced Neck

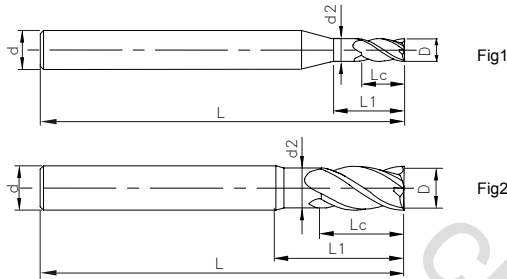

See page 97 for guidelines to icons

Ordering Code	D	Lc	d2	L1	L	d	Figure No.	Stock
SH200-SN4-01005-H	1	2	0.96	5	60	4	1	●
SH200-SN4-61005-H	1	2	0.96	5	60	6	1	○
SH200-SN4-61505-H	1.5	3	1.44	5	60	6	1	○
SH200-SN4-01507-H	1.5	3	1.44	7.5	60	4	1	●
SH200-SN4-61507-H	1.5	3	1.44	7.5	60	6	1	○
SH200-SN4-62007-H	2	4	1.92	7	60	6	1	○
SH200-SN4-02010-H	2	4	1.92	10	60	4	1	●
SH200-SN4-62010-H	2	4	1.92	10	60	6	1	○
SH200-SN4-02510-H	2.5	5	2.4	10	60	4	1	●
SH200-SN4-02513-H	2.5	2	2.4	12.5	60	4	1	○

● Stock ○ Available upon Order

D	Tol
D ≤ 6	0 -0.015
6 < D ≤ 12	0 -0.02
D > 12	0 -0.03

unit(mm)

Workpiece Material					
P			H		
1	2	3	4	5	6
Carbon Steel, Alloy Steel (< 35HRC)	Alloy Steel (35-48HRC)	PH, Ferrite, MartensiteSteel (< 35HRC)	Hardened Steel (45-55HRC)	Hardened Steel (55-60HRC)	Hardened Steel (> 60HRC)
○	◎		◎	○	

◎ Most Suitable ○ Suitable

Cutting Parameters ※ P462

SH200-SN4-H

4 Flute, with Reduced Neck

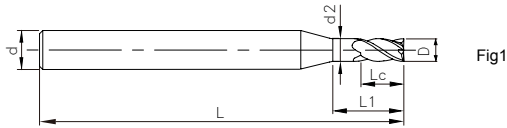

Fig1

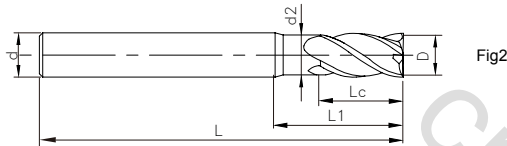

Fig2



See page 97 for guidelines to icons

» continue

Ordering Code	D	Lc	d2	L1	L	d	Figure No.	Stock
SH200-SN4-63010-H	3	6	2.88	10	60	6	1	○
SH200-SN4-63013-H	3	8	2.88	13	60	6	1	○
SH200-SN4-03015-H	3	6	2.88	15	60	4	1	●
SH200-SN4-63015-H	3	6	2.88	15	60	6	1	○
SH200-SN4-63015E-H	3	6	2.88	15	75	6	1	○
SH200-SN4-64016-H	4	10	3.85	16.5	50	6	1	●
SH200-SN4-04020-H	4	8	3.85	20	75	4	2	●
SH200-SN4-64020-H	4	8	3.85	20	75	6	1	○
SH200-SN4-64020E-H	4	8	3.85	20	60	6	1	●
SH200-SN4-05025-H	5	10	4.8	25	75	6	1	○

● Stock ○ Available upon Order

D	Tol
D 6	0 -0.015
6 < D 12	0 -0.02
D > 12	0 -0.03

unit(mm)

Workpiece Material					
P			H		
1 2 3 4	5	6	1	2	3 4
Carbon Steel, Alloy Steel (< 35HRC)	Alloy Steel (35-48HRC)	PH, Ferrite, MartensiteSteel (< 35HRC)	Hardened Steel (45-55HRC)	Hardened Steel (55-60HRC)	Hardened Steel (> 60HRC)
○	◎		◎	○	

◎ Most Suitable ○ Suitable

Cutting Parameters ※ P462

SH200-SN4-H

4 Flute, with Reduced Neck

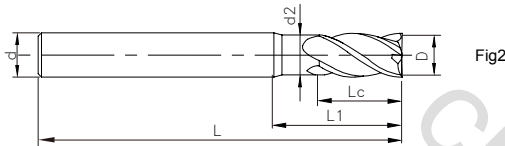
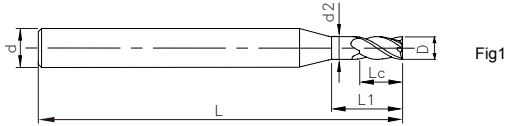

See page 97 for guidelines to icons

» continue

Ordering Code	D	Lc	d2	L1	L	d	Figure No.	Stock
SH200-SN4-06030J-H	6	12	5.8	30	75	6	2	●
SH200-SN4-06030-H	6	12	5.8	30	100	6	2	●
SH200-SN4-08030-H	8	20	7.8	30	60	8	2	○
SH200-SN4-08040-H	8	16	7.8	40	100	8	2	●
SH200-SN4-10035-H	10	25	9.8	35	75	10	2	○
SH200-SN4-10042-H	10	30	9.8	42	100	10	2	○
SH200-SN4-10050-H	10	20	9.8	50	100	10	2	●
SH200-SN4-12048-H	12	30	11.8	48	100	12	2	○
SH200-SN4-12060-H	12	24	11.8	60	120	12	2	●

● Stock ○ Available upon Order

D	Tol
D 6	0 -0.015
6 < D 12	0 -0.02
D > 12	0 -0.03

unit(mm)

Workpiece Material					
P			H		
1	2	3	4	5	6
Carbon Steel, Alloy Steel (< 35HRC)	Alloy Steel (35-48HRC)	PH, Ferrite, MartensiteSteel (< 35HRC)	Hardened Steel (45-55HRC)	Hardened Steel (55-60HRC)	Hardened Steel (> 60HRC)
○	◎		◎	○	

◎ Most Suitable ○ Suitable

Cutting Parameters ※ P462

SH200-SL4-H

4 Flute, Long Flute Length

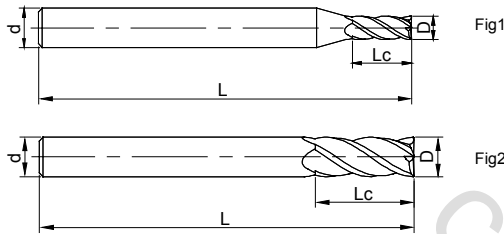

See page 97 for guidelines to icons

» continue

Ordering Code	D	Lc	L	d	Figure No.	Stock
SH200-SL4-62007-H	2	7	60	6	1	●
SH200-SL4-62009-H	2	9	60	6	1	○
SH200-SL4-04013-H	4	13	50	4	2	○
SH200-SL4-64017-H	4	17	60	6	1	○
SH200-SL4-06020-H	6	20	75	6	2	○
SH200-SL4-06025-H	6	25	75	6	2	●
SH200-SL4-08025-H	8	25	100	8	2	○
SH200-SL4-08034-H	8	34	100	8	2	○
SH200-SL4-10032-H	10	32	100	10	2	○
SH200-SL4-10042-H	10	42	100	10	2	●
SH200-SL4-12038-H	12	38	100	12	2	○
SH200-SL4-12050-H	12	50	100	12	2	●
SH200-SL4-16050-H	16	50	150	16	2	○
SH200-SL4-16060-H	16	60	150	16	2	○

● Stock ○ Available upon Order

D	Tol
D 6	0 -0.015
6 < D 12	0 -0.02
D > 12	0 -0.03

unit(mm)

Workpiece Material					
P			H		
1	2	3	4	5	6
Carbon Steel, Alloy Steel (< 35HRC)	Alloy Steel (35-48HRC)	PH, Ferrite, MartensiteSteel (< 35HRC)	Hardened Steel (45-55HRC)	Hardened Steel (55-60HRC)	Hardened Steel (> 60HRC)
○	◎		◎	○	

◎ Most Suitable ○ Suitable

Cutting Parameters ※ P462

SH300-S2-H NEW

2 Flute, Standard Length

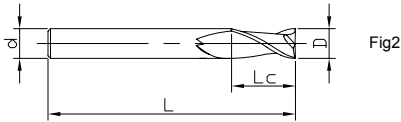
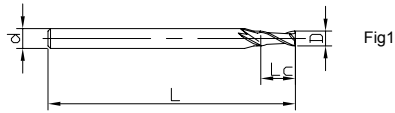

See page 97 for guidelines to icons

Ordering Code	D	Lc	L	d	Figure No.	Stock
SH300-S2-01003-H	1	2.5	50	4	1	○
SH300-S2-01504-H	1.5	3.75	50	4	1	○
SH300-S2-02005-H	2	5	50	4	1	○
SH300-S2-03008-H	3	7.5	50	4	1	○
SH300-S2-63008-H	3	7.5	50	6	1	○
SH300-S2-04010-H	4	10	50	4	2	○
SH300-S2-64010-H	4	10	50	6	1	○
SH300-S2-05013-H	5	12.5	50	6	1	○
SH300-S2-06015-H	6	15	50	6	2	○
SH300-S2-08020-H	8	20	60	8	2	○
SH300-S2-08020E-H	8	20	75	8	2	○
SH300-S2-10025-H	10	25	75	10	2	○
SH300-S2-12030-H	12	30	75	10	2	○

●Stock ○Available upon Order

D	Tol
D 12	0 -0.01
D > 12	0 -0.015

unit(mm)

Workpiece Material					
P			H		
1	2	3	4	5	6
Carbon Steel, Alloy Steel (< 35HRC)	Alloy Steel (35-48HRC)	PH, Ferrite, MartensiteSteel (< 35HRC)	Hardened Steel (45-55HRC)	Hardened Steel (55-60HRC)	Hardened Steel (> 60HRC)
	○		○	◎	◎

● Most Suitable ○ Suitable

Cutting Parameters ※ P463

SH300-SN2-H NEW

2 Flute, with Reduced Neck

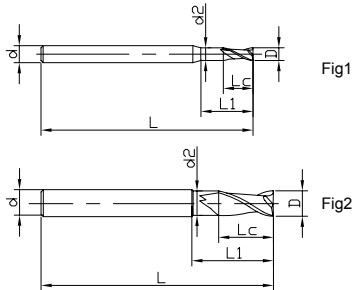

See page 97 for guidelines to icons

Ordering Code	D	Lc	d2	L1	L	d	Figure No.	Stock
SH300-SN2-01003-H	1	1.5	0.95	3	50	4	1	○
SH300-SN2-01006-H	1	1.5	0.95	6	50	4	1	○
SH300-SN2-01505-H	1.5	2.25	1.45	4.5	50	4	1	○
SH300-SN2-01509-H	1.5	2.25	1.45	9	50	4	1	○
SH300-SN2-02006-H	2	3	1.95	6	50	4	1	○
SH300-SN2-02012-H	2	3	1.95	12	60	4	1	○
SH300-SN2-63009-H	3	4.5	2.9	9	60	6	1	○
SH300-SN2-63018-H	3	4.5	2.9	18	60	6	1	○
SH300-SN2-64012-H	4	6	3.9	12	60	6	1	○
SH300-SN2-64024-H	4	6	3.9	24	75	6	1	○
SH300-SN2-05015-H	5	7.5	4.9	15	60	6	1	○
SH300-SN2-05030-H	5	7.5	4.9	30	75	6	1	○
SH300-SN2-06018-H	6	9	5.9	18	75	6	2	○
SH300-SN2-06036-H	6	9	5.9	36	90	6	2	○

● Stock ○ Available upon Order

D	Tol
D ≤ 12	0 -0.01
D > 12	0 -0.015

unit(mm)

Workpiece Material					
P			H		
1	2	3	4	5	6
Carbon Steel, Alloy Steel (< 35HRC)	Alloy Steel (35-48HRC)	PH, Ferrite, MartensiteSteel (< 35HRC)	Hardened Steel (45-55HRC)	Hardened Steel (55-60HRC)	Hardened Steel (> 60HRC)
	○		○	◎	◎

● Most Suitable ○ Suitable

Cutting Parameters ※ P463

SH300-SS4-H NEW

4 Flute, Stub Length

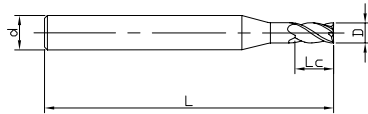

Fig1

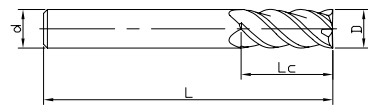

Fig2



See page 97 for guidelines to icons

Ordering Code	D	Lc	L	d	Figure No.	Stock
SH300-SS4-31002-H	1	2	50	3	1	○
SH300-SS4-01002-H	1	2	50	4	1	○
SH300-SS4-61002-H	1	2	50	6	1	○
SH300-SS4-31503-H	1.5	3	50	3	1	○
SH300-SS4-01503-H	1.5	3	50	4	1	○
SH300-SS4-61503-H	1.5	3	50	6	1	○
SH300-SS4-33004-H	2	4	50	3	1	○
SH300-SS4-03004-H	2	4	50	4	1	○
SH300-SS4-63004-H	2	4	50	6	1	○
SH300-SS4-33006-H	3	6	50	3	2	○
SH300-SS4-03006-H	3	6	50	4	1	○
SH300-SS4-63006-H	3	6	50	6	1	○

●Stock ○Available upon Order

D	Tol
D 8	0 -0.01
10 D 12	0 -0.015
D > 12	0 -0.02

unit(mm)

Workpiece Material					
P			H		
1	2	3	4	5	6
Carbon Steel, Alloy Steel (< 35HRC)	Alloy Steel (35-48HRC)	PH, Ferrite, MartensiteSteel (< 35HRC)	Hardened Steel (45-55HRC)	Hardened Steel (55-60HRC)	Hardened Steel (> 60HRC)
	○		○	◎	◎

◎ Most Suitable ○ Suitable

Cutting Parameters ※ P463

SH300-SS4-H NEW

4 Flute, Stub Length

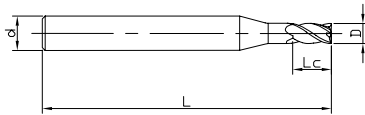

Fig1

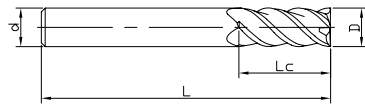

Fig2



See page 97 for guidelines to icons

» continue

Ordering Code	D	Lc	L	d	Figure No.	Stock
SH300-SS4-04008-H	4	8	50	4	2	○
SH300-SS4-64008-H	4	8	50	6	1	○
SH300-SS4-05010-H	5	10	50	6	1	○
SH300-SS4-06012-H	6	12	50	6	2	○
SH300-SS4-08012E-H	8	12	75	8	2	○
SH300-SS4-08016-H	8	16	60	8	2	○
SH300-SS4-10020-H	10	20	75	10	2	○
SH300-SS4-12024-H	12	24	75	12	2	○
SH300-SS4-14028-H	14	28	100	14	2	○
SH300-SS4-16032-H	16	32	100	16	2	○

● Stock ○ Available upon Order

D	Tol
D 8	0 -0.01
10 D 12	0 -0.015
D > 12	0 -0.02

unit(mm)

Workpiece Material

P			H		
1	2	3	4	5	6
Carbon Steel, Alloy Steel (< 35HRC)	Alloy Steel (35-48HRC)	PH, Ferrite, MartensiteSteel (< 35HRC)	Hardened Steel (45-55HRC)	Hardened Steel (55-60HRC)	Hardened Steel (> 60HRC)
	○		○	◎	◎

● Most Suitable ○ Suitable

Cutting Parameters ※ P463

SH300-S4-H NEW

4 Flute, Standard Length

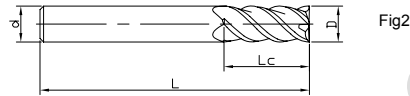
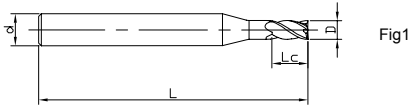

See page 97 for guidelines to icons

Ordering Code	D	Lc	L	d	Figure No.	Stock
SH300-S4-31004-H	1	3.5	50	3	1	○
SH300-S4-01004-H	1	3.5	50	4	1	●
SH300-S4-61004-H	1	3.5	50	6	1	○
SH300-S4-31505-H	1.5	5	50	3	1	○
SH300-S4-01505-H	1.5	5	50	4	1	●
SH300-S4-61505-H	1.5	5	50	6	1	○
SH300-S4-32007-H	2	7	50	3	1	○
SH300-S4-02007-H	2	7	50	4	1	●
SH300-S4-62007-H	2	7	50	6	1	○
SH300-S4-33010-H	3	10	50	3	2	○
SH300-S4-03010-H	3	10	50	4	1	●
SH300-S4-63010-H	3	10	50	6	1	○
SH300-S4-04012-H	4	12	50	4	2	●

● Stock ○ Available upon Order

D	Tol
D 8	0 -0.01
10 D 12	0 -0.015
D > 12	0 -0.02

unit(mm)

Workpiece Material					
P			H		
1 2 3 4	5	6	1	2	3 4
Carbon Steel, Alloy Steel (< 35HRC)	Alloy Steel (35-48HRC)	PH, Ferrite, Martensite Steel (< 35HRC)	Hardened Steel (45-55HRC)	Hardened Steel (55-60HRC)	Hardened Steel (> 60HRC)
	○		○	◎	◎

◎ Most Suitable ○ Suitable

Cutting Parameters ※ P463

SH300-S4-H NEW

4 Flute, Standard Length

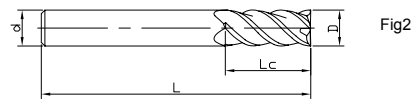
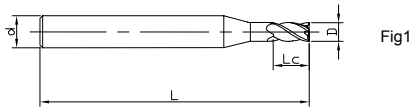

See page 97 for guidelines to icons

» continue

Ordering Code	D	Lc	L	d	Figure No.	Stock
SH300-S4-64012-H	4	12	50	6	1	○
SH300-S4-05015-H	5	15	50	6	1	○
SH300-S4-06015-H	6	15	50	6	2	●
SH300-S4-08020-H	8	20	60	8	2	●
SH300-S4-08020E-H	8	20	75	8	2	●
SH300-S4-10025-H	10	25	75	10	2	●
SH300-S4-10025E-H	10	25	90	10	2	○
SH300-S4-12030-H	12	30	75	12	2	●
SH300-S4-12030E-H	12	30	90	12	2	○
SH300-S4-14035-H	14	35	100	14	2	○
SH300-S4-16040-H	16	40	100	16	2	○
SH300-S4-18040-H	18	40	100	18	2	○
SH300-S4-20045-H	20	45	100	20	2	○

● Stock ○ Available upon Order

D	Tol
D 8	$\begin{matrix} 0 \\ -0.01 \end{matrix}$
10 D 12	$\begin{matrix} 0 \\ -0.015 \end{matrix}$
D > 12	$\begin{matrix} 0 \\ -0.02 \end{matrix}$

unit(mm)

Workpiece Material					
P			H		
1	2	3	4	5	6
Carbon Steel, Alloy Steel (< 35HRC)	Alloy Steel (35-48HRC)	PH, Ferrite, Martensite Steel (< 35HRC)	Hardened Steel (45-55HRC)	Hardened Steel (55-60HRC)	Hardened Steel (> 60HRC)
	○		○	◎	◎

◎ Most Suitable ○ Suitable

Cutting Parameters ※ P463

SH300-SH4-H NEW

4 Flute, with Long Shank Length

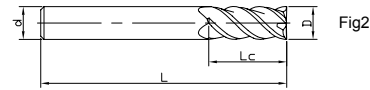
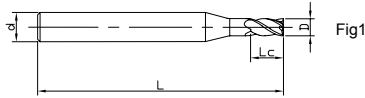

See page 97 for guidelines to icons

Ordering Code	D	Lc	L	d	Figure No.	Stock
SH300-SH4-31004-H	1	3.5	60	3	1	○
SH300-SH4-01004-H	1	3.5	60	4	1	●
SH300-SH4-61004-H	1	3.5	60	6	1	○
SH300-SH4-31505-H	1.5	5	60	3	1	○
SH300-SH4-01505-H	1.5	5	60	4	1	●
SH300-SH4-61505-H	1.5	5	60	6	1	○
SH300-SH4-32007-H	2	7	60	3	1	○
SH300-SH4-02007-H	2	7	60	4	1	●
SH300-SH4-62007-H	2	7	60	6	1	○
SH300-SH4-33010-H	3	10	60	3	2	○
SH300-SH4-03010-H	3	10	60	4	1	●
SH300-SH4-63010-H	3	10	60	6	1	○

● Stock ○ Available upon Order

D	Tol
D 8	$\begin{matrix} 0 \\ -0.01 \end{matrix}$
10 D 12	$\begin{matrix} 0 \\ -0.015 \end{matrix}$
D > 12	$\begin{matrix} 0 \\ -0.02 \end{matrix}$

unit(mm)

Workpiece Material					
P			H		
1	2	3	4	5	6
Carbon Steel, Alloy Steel (< 35HRC)	Carbon Steel, Alloy Steel (< 35HRC)	PH, Ferrite, MartensiteSteel (< 35HRC)	Hardened Steel (45-55HRC)	Hardened Steel (55-60HRC)	Hardened Steel (> 60HRC)
	○		○	◎	◎

◎ Most Suitable ○ Suitable

Cutting Parameters ※ P463

SH300-SH4-H NEW

4 Flute, with Long Shank Length

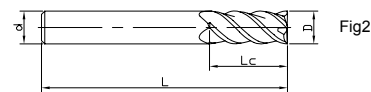
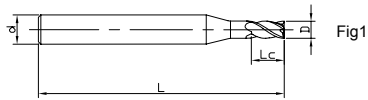

See page 97 for guidelines to icons

» continue

Ordering Code	D	Lc	L	d	Figure No.	Stock
SH300-SH4-04012-H	4	12	60	4	2	●
SH300-SH4-64012-H	4	12	60	6	1	○
SH300-SH4-05015-H	5	15	60	6	1	○
SH300-SH4-06015-H	6	15	60	6	2	○
SH300-SH4-06015E-H	6	15	75	6	2	●
SH300-SH4-08020E-H	8	20	100	8	2	●
SH300-SH4-10025-H	10	25	100	10	2	●
SH300-SH4-12030-H	12	30	100	12	2	●
SH300-SH4-14035-H	14	35	120	14	2	○
SH300-SH4-16040-H	16	40	120	16	2	○
SH300-SH4-18040-H	18	40	150	18	2	○
SH300-SH4-20045-H	20	45	150	20	2	○

● Stock ○ Available upon Order

D	Tol
D 8	0 -0.01
10 D 12	0 -0.015
D > 12	0 -0.02

unit(mm)

Workpiece Material					
P			H		
1	2	3	4	5	6
Carbon Steel, Alloy Steel (< 35HRC)	Carbon Steel, Alloy Steel (< 35HRC)	PH, Ferrite, Martensite Steel (< 35HRC)	Hardened Steel (45-55HRC)	Hardened Steel (55-60HRC)	Hardened Steel (> 60HRC)
	○		○	◎	◎

◎ Most Suitable ○ Suitable

Cutting Parameters ※ P463

SH300-SL4-H NEW

4 Flute, Long Flute Length

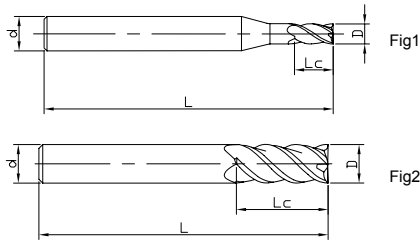

See page 97 for guidelines to icons

Ordering Code	D	Lc	L	d	Figure No.	Stock
SH300-SL4-01004-H	1	4	60	4	1	○
SH300-SL4-01006-H	1	6	60	4	1	●
SH300-SL4-61004-H	1	4	60	6	1	○
SH300-SL4-01508-H	1.5	8	60	4	1	●
SH300-SL4-61508-H	1.5	8	60	6	1	○
SH300-SL4-02008-H	2	8	60	4	1	○
SH300-SL4-62008-H	2	8	60	6	1	○
SH300-SL4-03012-H	3	12	60	4	1	○
SH300-SL4-63012-H	3	12	60	6	1	○
SH300-SL4-04016-H	4	16	60	4	2	○
SH300-SL4-64016-H	4	16	60	6	1	○

● Stock ○ Available upon Order

D	Tol
D 8	0 -0.01
10 D 12	0 -0.015
D > 12	0 -0.02

unit(mm)

Workpiece Material					
P			H		
1	2	3	4	5	6
Carbon Steel, Alloy Steel (< 35HRC)	Alloy Steel (35-48HRC)	PH, Ferrite, MartensiteSteel (< 35HRC)	Hardened Steel (45-55HRC)	Hardened Steel (55-60HRC)	Hardened Steel (> 60HRC)
	○		○	◎	◎

◎ Most Suitable ○ Suitable

Cutting Parameters ※ P463

SH300-SL4-H NEW

4 Flute, Long Flute Length

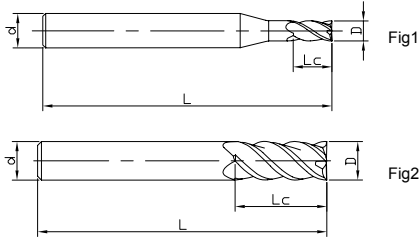

See page 97 for guidelines to icons

» continue

Ordering Code	D	Lc	L	d	Figure No.	Stock
SH300-SL4-05020-H	5	20	60	6	1	○
SH300-SL4-06020-H	6	20	60	6	2	○
SH300-SL4-06025E-H	6	25	75	6	2	○
SH300-SL4-08025-H	8	25	75	8	2	○
SH300-SL4-08030-H	8	30	75	8	2	○
SH300-SL4-10040-H	10	40	100	10	2	○
SH300-SL4-12040-H	12	40	100	12	2	○
SH300-SL4-14545-H	14	45	120	14	2	○
SH300-SL4-16055-H	16	55	120	16	2	○
SH300-SL4-20060-H	20	60	120	20	2	○

● Stock ○ Available upon Order

D	Tol
D 8	0 -0.01
10 D 12	0 -0.015
D > 12	0 -0.02

unit(mm)

Workpiece Material					
P			H		
1	2	3	4	5	6
Carbon Steel, Alloy Steel (< 35HRC)	Alloy Steel (35-48HRC)	PH, Ferrite, MartensiteSteel (< 35HRC)	Hardened Steel (45-55HRC)	Hardened Steel (55-60HRC)	Hardened Steel (> 60HRC)
	○		○	◎	◎

● Most Suitable ○ Suitable

Cutting Parameters ※ P463

SH300-SN4-H NEW

4 Flute, with Reduced Neck

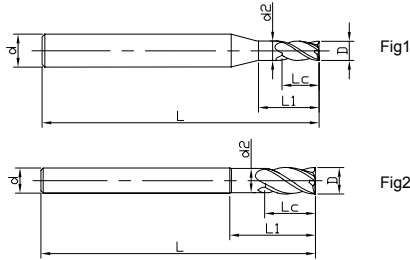

See page 97 for guidelines to icons

Ordering Code	D	Lc	d2	L1	L	d	Figure No.	Stock
SH300-SN4-31004-H	1	2	0.96	4	50	3	1	○
SH300-SN4-01004-H	1	2	0.96	4	50	4	1	○
SH300-SN4-61004-H	1	2	0.96	4	50	6	1	○
SH300-SN4-31004E-H	1	2	0.96	4	60	3	1	○
SH300-SN4-01004E-H	1	2	0.96	4	60	4	1	●
SH300-SN4-61004E-H	1	2	0.96	4	60	6	1	●
SH300-SN4-31506-H	1.5	3	1.45	6	50	3	1	○
SH300-SN4-01506-H	1.5	3	1.45	6	50	4	1	○
SH300-SN4-61506-H	1.5	3	1.45	6	50	6	1	○
SH300-SN4-31506E-H	1.5	3	1.45	6	60	3	1	○
SH300-SN4-01506E-H	1.5	3	1.45	6	60	4	1	○
SH300-SN4-61508E-H	1.5	3	1.45	8	60	4	1	○

● Stock ○ Available upon Order

D	Tol
D 8	0 -0.01
10 D 12	0 -0.015
D > 12	0 -0.02

unit(mm)

Workpiece Material					
P			H		
1	2	3	4	5	6
Carbon Steel, Alloy Steel (< 35HRC)	Alloy Steel (35-48HRC)	PH, Ferrite, MartensiteSteel (< 35HRC)	Hardened Steel (45-55HRC)	Hardened Steel (55-60HRC)	Hardened Steel (> 60HRC)
	○		○	◎	◎

◎ Most Suitable ○ Suitable

Cutting Parameters ※ P463

SH300-SN4-H NEW

4 Flute, with Reduced Neck

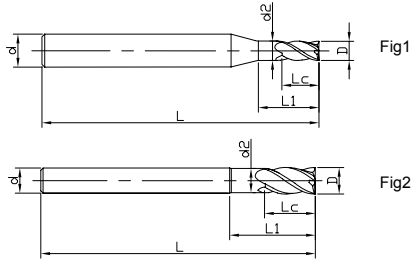

See page 97 for guidelines to icons

» continue

Ordering Code	D	Lc	d2	L1	L	d	Figure No.	Stock
SH300-SN4-61506E-H	1.5	3	1.45	6	60	6	1	●
SH300-SN4-32008-H	2	4	1.9	8	50	3	1	○
SH300-SN4-02008-H	2	4	1.9	8	50	4	1	○
SH300-SN4-62008-H	2	4	1.9	8	50	6	1	○
SH300-SN4-32008E-H	2	4	1.9	8	60	3	1	○
SH300-SN4-02008E-H	2	4	1.9	8	60	4	1	●
SH300-SN4-62008E-H	2	4	1.9	8	60	6	1	●
SH300-SN4-33012-H	3	6	2.9	12	50	3	2	○
SH300-SN4-03012-H	3	6	2.9	12	50	4	1	○
SH300-SN4-63012-H	3	6	2.9	12	50	6	1	○
SH300-SN4-33012E-H	3	6	2.9	12	60	3	2	○
SH300-SN4-03012E-H	3	6	2.9	12	60	4	1	○

● Stock ○ Available upon Order

D	Tol
D 8	$\begin{matrix} 0 \\ -0.01 \end{matrix}$
10 D 12	$\begin{matrix} 0 \\ -0.015 \end{matrix}$
D > 12	$\begin{matrix} 0 \\ -0.02 \end{matrix}$

unit(mm)

Workpiece Material					
P			H		
1	2	3	4	5	6
Carbon Steel, Alloy Steel (< 35HRC)	Alloy Steel (35-48HRC)	PH, Ferrite, Martensite Steel (< 35HRC)	Hardened Steel (45-55HRC)	Hardened Steel (55-60HRC)	Hardened Steel (> 60HRC)
	○		○	◎	◎

◎ Most Suitable ○ Suitable

Cutting Parameters ※ P463

SH300-SN4-H NEW

4 Flute, with Reduced Neck

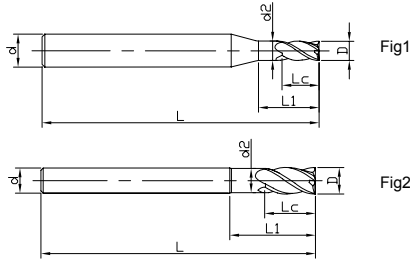

See page 97 for guidelines to icons

» continue

Ordering Code	D	Lc	d2	L1	L	d	Figure No.	Stock
SH300-SN4-63009E-H	3	6	2.9	9	60	6	1	●
SH300-SN4-63012E-H	3	6	2.9	12	60	6	1	●
SH300-SN4-64012E-H	4	8	3.9	12	60	6	1	●
SH300-SN4-04016-H	4	8	3.9	16	50	4	2	○
SH300-SN4-64016-H	4	8	3.9	16	50	6	1	○
SH300-SN4-04016E-H	4	8	3.9	16	60	4	2	○
SH300-SN4-64016E-H	4	8	3.9	16	60	6	1	●
SH300-SN4-05020-H	5	10	5.9	20	50	6	1	○
SH300-SN4-05020E-H	5	10	5.9	20	60	6	1	○
SH300-SN4-05020F-H	5	10	5.9	20	75	6	1	○
SH300-SN4-06018E-H	6	12	5.9	18	60	6	2	●
SH300-SN4-06024-H	6	12	5.9	24	75	6	2	○

● Stock ○ Available upon Order

D	Tol
D 8	0 -0.01
10 D 12	0 -0.015
D > 12	0 -0.02

unit(mm)

Workpiece Material					
P			H		
1	2	3	4	5	6
Carbon Steel, Alloy Steel (< 35HRC)	Alloy Steel (35-48HRC)	PH, Ferrite, MartensiteSteel (< 35HRC)	Hardened Steel (45-55HRC)	Hardened Steel (55-60HRC)	Hardened Steel (> 60HRC)
	○		○	◎	◎

◎ Most Suitable ○ Suitable

Cutting Parameters ※ P463

SH300-SN4-H NEW

4 Flute, with Reduced Neck

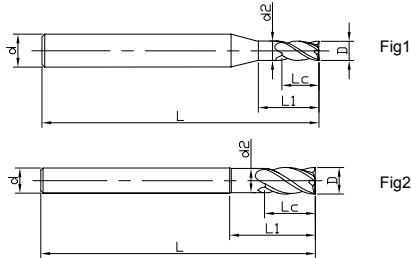

See page 97 for guidelines to icons

» continue

Ordering Code	D	Lc	d2	L1	L	d	Figure No.	Stock
SH300-SN4-06024E-H	6	12	5.9	24	90	6	2	○
SH300-SN4-06024F-H	6	12	5.9	24	100	6	2	○
SH300-SN4-08024-H	8	16	7.9	24	75	8	2	●
SH300-SN4-08032-H	8	16	7.9	32	75	8	2	○
SH300-SN4-08032E-H	8	16	7.9	32	100	8	2	○
SH300-SN4-10040-H	10	20	9.9	40	100	10	2	●
SH300-SN4-10040E-H	10	20	9.9	40	120	10	2	○
SH300-SN4-12048-H	12	24	11.9	48	100	12	2	●
SH300-SN4-12048E-H	12	24	11.9	48	120	12	2	○
SH300-SN4-14056-H	14	28	13.9	56	120	14	2	○
SH300-SN4-16064-H	16	32	15.9	64	120	16	2	○
SH300-SN4-20080-H	20	40	19.9	80	120	20	2	○

● Stock ○ Available upon Order

D	Tol
D 8	$\begin{matrix} 0 \\ -0.01 \end{matrix}$
10 D 12	$\begin{matrix} 0 \\ -0.015 \end{matrix}$
D > 12	$\begin{matrix} 0 \\ -0.02 \end{matrix}$

unit(mm)

Workpiece Material					
P			H		
1 2 3 4	5	6	1	2	3 4
Carbon Steel, Alloy Steel (< 35HRC)	Alloy Steel (35-48HRC)	PH, Ferrite, MartensiteSteel (< 35HRC)	Hardened Steel (45-55HRC)	Hardened Steel (55-60HRC)	Hardened Steel (> 60HRC)
	○		○	◎	◎

◎ Most Suitable ○ Suitable

Cutting Parameters ※ P463

SH300-S6-H NEW

6 Flute, Standard Length

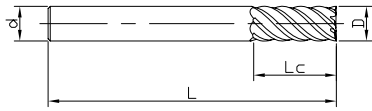

Fig1



See page 97 for guidelines to icons

Ordering Code	D	Lc	L	d	Figure No.	Stock
SH300-S6-06015-H	6	15	50	6	1	●
SH300-S6-08020-H	8	20	60	8	1	●
SH300-S6-08020E-H	8	20	75	8	1	○
SH300-S6-10025-H	10	25	75	10	1	●
SH300-S6-12030-H	12	30	75	12	1	○
SH300-S6-14035-H	14	35	100	14	1	○
SH300-S6-16040-H	16	40	100	16	1	○
SH300-S6-18040-H	18	40	100	18	1	○
SH300-S6-20045-H	20	45	100	20	1	○

● Stock ○ Available upon Order

D	Tol
D 12	0 -0.015
D > 12	0 -0.02

unit(mm)

Workpiece Material					
P			H		
1	2	3	4	5	6
Carbon Steel, Alloy Steel (< 35HRC)	Alloy Steel (35-48HRC)	PH, Ferrite, MartensiteSteel (< 35HRC)	Hardened Steel (45-55HRC)	Hardened Steel (55-60HRC)	Hardened Steel (> 60HRC)
	○		○	◎	◎

◎ Most Suitable ○ Suitable

Cutting Parameters ※ P464

SH300-SH6-H NEW

6 Flute, with Long Shank Length

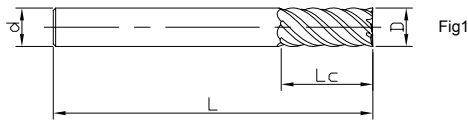

See page 97 for guidelines to icons

Ordering Code	D	Lc	L	d	Figure No.	Stock
SH300-SH6-06015-H	6	15	60	6	1	○
SH300-SH6-06015E-H	6	15	75	6	1	○
SH300-SH6-08020-H	8	20	90	8	1	○
SH300-SH6-10025-H	10	25	100	10	1	○
SH300-SH6-12030-H	12	30	100	12	1	●
SH300-SH6-14035-H	14	35	120	14	1	○
SH300-SH6-16040-H	16	40	120	16	1	○
SH300-SH6-18040-H	18	40	120	18	1	○
SH300-SH6-20045-H	20	45	120	20	1	○

● Stock ○ Available upon Order

D	Tol
D ≤ 12	0 -0.015
D > 12	0 -0.02

unit(mm)

Workpiece Material					
P			H		
1	2	3	4	5	6
Carbon Steel, Alloy Steel (< 35HRC)	Alloy Steel (35-48HRC)	PH, Ferrite, MartensiteSteel (< 35HRC)	Hardened Steel (45-55HRC)	Hardened Steel (55-60HRC)	Hardened Steel (> 60HRC)
	○		○	◎	◎

◎ Most Suitable ○ Suitable

Cutting Parameters ※ P464

SH300-SL6-H NEW

6 Flute, Long Flute Length

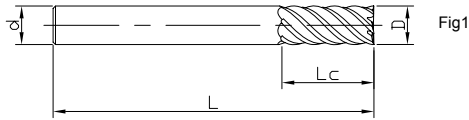

See page 97 for guidelines to icons

Ordering Code	D	Lc	L	d	Figure No.	Stock
SH300-SL6-06025-H	6	25	75	6	1	○
SH300-SL6-08035-H	8	35	100	8	1	○
SH300-SL6-10045-H	10	45	100	10	1	○
SH300-SL6-12055-H	12	55	100	12	1	○
SH300-SL6-14055-H	14	55	120	14	1	○
SH300-SL6-16065-H	16	65	120	16	1	○
SH300-SL6-18065-H	18	65	150	18	1	○
SH300-SL6-20075-H	20	75	150	20	1	○

● Stock ○ Available upon Order

D	Tol
D 12	0 -0.015
D > 12	0 -0.02

unit(mm)

Workpiece Material					
P			H		
1	2	3	4	5	6
Carbon Steel, Alloy Steel (< 35HRC)				Alloy Steel (35-48HRC)	PH, Ferrite, MartensiteSteel (< 35HRC)
					Hardened Steel (45-55HRC)
					Hardened Steel (55-60HRC)
					Hardened Steel (> 60HRC)
				○	○
					◎
					◎

● Most Suitable ○ Suitable

Cutting Parameters ※ P464

SHM100-SN2

2 Flute, Square, Micro diameter with Reduce Neck

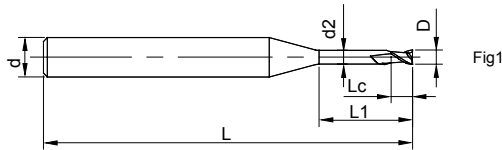

See page 97 for guidelines to icons

Ordering Code	D	Lc	d2	L1	L	d	Figure No.	Stock
SHM100-SN2-00401	0.4	0.6	0.36	1	50	4	1	○
SHM100-SN2-00402	0.4	0.6	0.36	2	50	4	1	○
SHM100-SN2-00403	0.4	0.6	0.36	3	50	4	1	●
SHM100-SN2-00602	0.6	0.8	0.56	2	50	4	1	○
SHM100-SN2-00604	0.6	0.8	0.56	4	50	4	1	●
SHM100-SN2-00606	0.6	0.8	0.56	6	50	4	1	●
SHM100-SN2-08002	0.8	1.2	0.75	2	50	4	1	○
SHM100-SN2-00804	0.8	1.2	0.75	4	50	4	1	○
SHM100-SN2-00806	0.8	1.2	0.75	6	50	4	1	●

● Stock ○ Available upon Order

D	Tol
0.4 D 2	$\begin{matrix} 0 \\ -0.02 \end{matrix}$

unit(mm)

Workpiece Material						
P		M	K	H		
1 2 3 4	5	1 2 3	1 2 3	1	2	3 4
Carbon Steel, Alloy Steel (< 35HRC)	Alloy Steel (35-48HRC)	Stainless Steel	Cast Iron	Hardened Steel (45-55HRC)	Hardened Steel (55-60HRC)	Hardened Steel (> 60HRC)
				⊙		

● Most Suitable ○ Suitable

Cutting Parameters ※ P469

SHM100-SN2

2 Flute, Square, Micro diameter with Reduce Neck

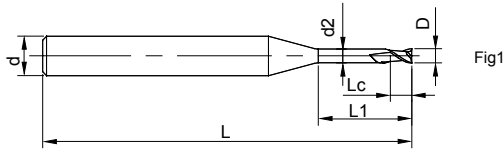

Fig1



See page 97 for guidelines to icons

» continue

Ordering Code	D	Lc	d2	L1	L	d	Figure No.	Stock
SHM100-SN2-01006	1.0	1.5	0.95	6	50	4	1	○
SHM100-SN2-01008	1.0	1.5	0.95	8	50	4	1	●
SHM100-SN2-01010	1.0	1.5	0.95	10	50	4	1	●
SHM100-SN2-01508	1.5	2.0	1.44	8	50	4	1	●
SHM100-SN2-01510	1.5	2.0	1.44	10	50	4	1	●
SHM100-SN2-01512	1.5	2.0	1.44	12	50	4	1	●
SHM100-SN2-02008	2.0	3.0	1.92	8	50	4	1	○
SHM100-SN2-02010	2.0	3.0	1.92	10	50	4	1	●
SHM100-SN2-02012	2.0	3.0	1.92	12	50	4	1	●

●Stock ○Available upon Order

D	Tol
0.4 D 2	0 -0.02

unit(mm)

Workpiece Material

P		M	K	H		
1 2 3 4	5	1 2 3	1 2 3	1	2	3 4
(< 35HRC) Carbon Steel, Alloy Steel(<35 HRC)	Alloy Steel, Tool Steel(<48HRC)	Stainless Steel	Cast Iron	Hardened Steel (45-55HRC)	Hardened Steel (55-60HRC)	Hardened Steel (> 60HRC)
				⊙		

● Most Suitable ○ Suitable

Cutting Parameters ※ P469

UP100-R2

2 Flute Corner Radius

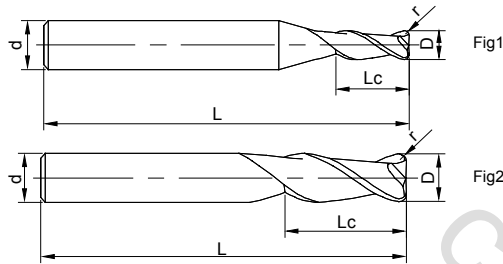

See page 97 for guidelines to icons

Ordering Code	D	Lc	r	L	d	Figure No.	Stock
UP100-R2-01001	1	3	0.1	50	4	1	○
UP100-R2-02002	2	6	0.2	50	4	1	○
UP100-R2-03002	3	9	0.2	50	4	1	○
UP100-R2-63002	3	9	0.2	50	6	1	○
UP100-R2-03003	3	9	0.3	50	4	1	○
UP100-R2-63003	3	9	0.3	50	6	1	○
UP100-R2-03005	3	9	0.5	50	4	1	○
UP100-R2-63005	3	9	0.5	50	6	1	○
UP100-R2-04002	4	11	0.2	50	4	2	○
UP100-R2-64002	4	11	0.2	50	6	1	○
UP100-R2-04003	4	11	0.3	50	4	2	○
UP100-R2-64003	4	11	0.3	50	6	1	○
UP100-R2-04005	4	11	0.5	50	4	2	○
UP100-R2-64005	4	11	0.5	50	6	1	○
UP100-R2-04010	4	11	1	50	4	2	○
UP100-R2-05002	5	13	0.2	50	6	1	○

●Stock ○Available upon Order

D	Tol
D ≤ 12	0 -0.02
D > 12	0 -0.03

unit(mm)

Workpiece Material						
P		M	K	N		
1 2 3 4	5	1 2 3	1 2 3	1 2 3	4	5
(< 35HRC) Carbon Steel, Alloy Steel(<35 HRC)	Alloy Steel, Tool Steel(<48HRC)	Stainless Steel	Cast Iron	Aluminium Alloys	Copper Alloys	Graphite
◎	○	○	◎	○	○	

◎ Most Suitable ○ Suitable

Cutting Parameters ※ P421

UP100-R2

2 Flute Corner Radius

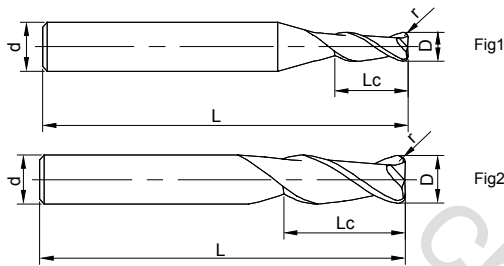

See page 97 for guidelines to icons

» continue

Ordering Code	D	Lc	r	L	d	Figure No.	Stock
UP100-R2-05003	5	13	0.3	50	6	1	○
UP100-R2-05005	5	13	0.5	50	6	1	○
UP100-R2-05010	5	13	1	50	6	1	○
UP100-R2-05015	5	13	1.5	50	6	1	○
UP100-R2-06005	6	16	0.5	50	6	2	○
UP100-R2-06010	6	16	1	50	6	2	○
UP100-R2-06015	6	16	1.5	50	6	2	○
UP100-R2-06020	6	16	2	50	6	2	○
UP100-R2-08003	8	20	0.3	60	8	2	○
UP100-R2-08005	8	20	0.5	60	8	2	○
UP100-R2-08010	8	20	1	60	8	2	○
UP100-R2-10015	10	25	1.5	75	10	2	○
UP100-R2-10020	10	25	2	75	10	2	○
UP100-R2-10030	10	25	3	75	10	2	○
UP100-R2-12005	12	30	0.5	75	12	2	○
UP100-R2-12010	12	30	1	75	12	2	○

●Stock ○Available upon Order

D	Tol
D 12	0 -0.02
D > 12	0 -0.03

unit(mm)

Workpiece Material						
P		M	K	N		
1234	5	123	123	123	4	5
Carbon Steel, Alloy Steel(<35 HRC)	Alloy Steel, Tool Steel(<48HRC)	Stainless Steel	Cast Iron	Aluminium Alloys	Copper Alloys	Graphite
⊙	○	○	⊙	○	○	

⊙ Most Suitable ○ Suitable

Cutting Parameters ※ P421

UP100-R2

2 Flute Corner Radius

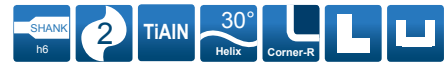
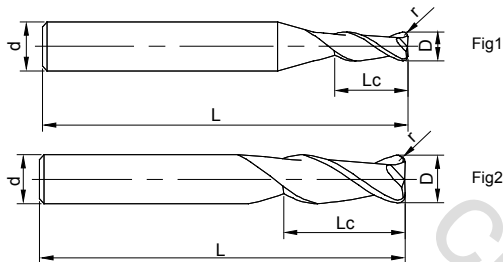

See page 97 for guidelines to icons

» continue

Ordering Code	D	Lc	r	L	d	Figure No.	Stock
UP100-R2-12015	12	30	1.5	75	12	2	○
UP100-R2-12020	12	30	2	75	12	2	○
UP100-R2-12030	12	30	3	75	12	2	○
UP100-R2-16010	16	36	1	100	16	2	○
UP100-R2-16020	16	36	2	100	16	2	○
UP100-R2-16030	16	36	3	100	16	2	○

● Stock ○ Available upon Order

D	Tol
D 12	$\begin{matrix} 0 \\ -0.02 \end{matrix}$
D > 12	$\begin{matrix} 0 \\ -0.03 \end{matrix}$

unit(mm)

Workpiece Material						
P		M	K	N		
1234	5	123	123	123	4	5
Carbon Steel, Alloy Steel(<35 HRC)	Alloy Steel, Tool Steel(<48HRC)	Stainless Steel	Cast Iron	Aluminium Alloys	Copper Alloys	Graphite
⊙	○	○	⊙	○	○	

● Most Suitable ○ Suitable

Cutting Parameters ※ P421

UP100-RH2

2 Flute Corner Radius, with Long Shank Length

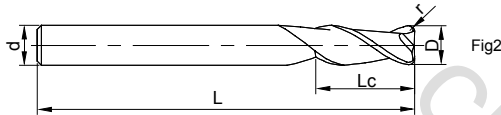
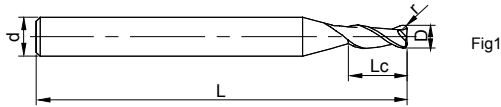

See page 97 for guidelines to icons

Ordering Code	D	Lc	r	L	d	Figure No.	Stock
UP100-RH2-06005	6	15	0.5	75	6	2	○
UP100-RH2-06010	6	15	1	75	6	2	○
UP100-RH2-06015	6	15	1.5	75	6	2	○
UP100-RH2-08005	8	20	0.5	100	8	2	○
UP100-RH2-08010	8	20	1	100	8	2	○
UP100-RH2-08015	8	20	1.5	100	8	2	○
UP100-RH2-10005	10	25	0.5	100	10	2	○
UP100-RH2-10010	10	25	1	100	10	2	○
UP100-RH2-10015	10	25	1.5	100	10	2	○
UP100-RH2-10020	10	25	2	100	10	2	○
UP100-RH2-12005	12	30	0.5	100	12	2	○
UP100-RH2-12010	12	30	1	100	12	2	○
UP100-RH2-12015	12	30	1.5	100	12	2	○
UP100-RH2-12020	12	30	2	100	12	2	○
UP100-RH2-16005	16	36	0.5	150	16	2	○
UP100-RH2-16010	16	36	1	150	16	2	○
UP100-RH2-16015	16	36	1.5	150	16	2	○
UP100-RH2-16020	16	36	2	150	16	2	○

●Stock ○Available upon Order

D	Tol
D ≤ 12	0 -0.02
D > 12	0 -0.03

unit(mm)

Workpiece Material						
P		M	K	N		
1234	5	123	123	123	4	5
Carbon Steel, Alloy Steel(<35 HRC)	Alloy Steel, Tool Steel(<48HRC)	Stainless Steel	Cast Iron	Aluminium Alloys	Copper Alloys	Graphite
⊙	○	○	⊙	○	○	

⊙ Most Suitable ○ Suitable

Cutting Parameters ※ P421

UP100-R4

4 Flute Corner Radius

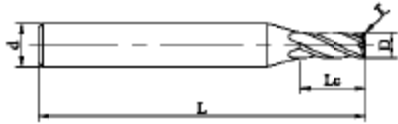

Fig1

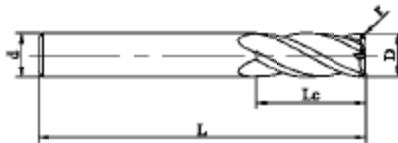

Fig2



See page 97 for guidelines to icons

Ordering Code	D	Lc	r	L	d	Figure No.	Stock
UP100-R4-02002	2	6	0.2	50	4	1	○
UP100-R4-03002	3	9	0.2	50	4	1	○
UP100-R4-03003	3	9	0.3	50	4	1	○
UP100-R4-03005	3	9	0.5	50	4	1	○
UP100-R4-04002	4	11	0.2	50	4	2	●
UP100-R4-04003	4	11	0.3	50	4	2	○
UP100-R4-04005	4	11	0.5	50	4	2	○
UP100-R4-04010	4	11	1	50	4	2	○
UP100-R4-05002	5	13	0.2	50	6	1	○
UP100-R4-05005	5	13	0.5	50	6	1	○
UP100-R4-05010	5	13	1	50	6	1	○
UP100-R4-05015	5	13	1.5	50	6	1	○
UP100-R4-06005	6	16	0.5	50	6	2	○
UP100-R4-06010	6	16	1	50	6	2	○
UP100-R4-06015	6	16	1.5	50	6	2	○
UP100-R4-08003	8	20	0.3	60	8	2	○

● Stock ○ Available upon Order

D	Tol
D 12	0 -0.02
D > 12	0 -0.03

unit(mm)

Workpiece Material						
P		M	K	N		
1234	5	123	123	123	4	5
Carbon Steel, Alloy Steel(<35 HRC)	Alloy Steel, Tool Steel(<48HRC)	Stainless Steel	Cast Iron	Aluminium Alloys	Copper Alloys	Graphite
◎	○	○	◎	○	○	

◎ Most Suitable ○ Suitable

Cutting Parameters ※ P422

UP100-R4

4 Flute Corner Radius

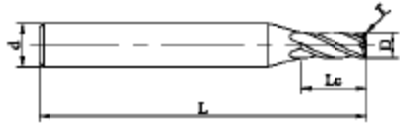

Fig1

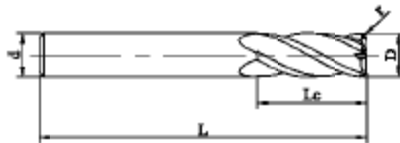

Fig2



See page 97 for guidelines to icons

» continue

Ordering Code	D	Lc	r	L	d	Figure No.	Stock
UP100-R4-08005	8	20	0.5	60	8	2	○
UP100-R4-08010	8	20	1	60	8	2	○
UP100-R4-08015	8	20	1.5	60	8	2	○
UP100-R4-08020	8	20	2	60	8	2	○
UP100-R4-10003	10	25	0.3	75	10	2	○
UP100-R4-10005	10	25	0.5	75	10	2	○
UP100-R4-10010	10	25	1	75	10	2	●
UP100-R4-10015	10	25	1.5	75	10	2	○
UP100-R4-10020	10	25	2	75	10	2	●
UP100-R4-10025	10	25	2.5	75	10	2	○
UP100-R4-10030	10	25	3	75	10	2	○
UP100-R4-12005	12	30	0.5	75	12	2	○
UP100-R4-12010	12	30	1	75	12	2	○
UP100-R4-12015	12	30	1.5	75	12	2	○
UP100-R4-12020	12	30	2	75	12	2	○
UP100-R4-12025	12	30	2.5	75	12	2	○

●Stock ○Available upon Order

D	Tol
D 12	0 -0.02
D > 12	0 -0.03

unit(mm)

Workpiece Material						
P		M	K	N		
1234	5	123	123	123	4	5
Carbon Steel, Alloy Steel(<35 HRC)	Alloy Steel, Tool Steel(<48HRC)	Stainless Steel	Cast Iron	Aluminium Alloys	Copper Alloys	Graphite
⊙	○	○	⊙	○	○	

⊙ Most Suitable ○ Suitable

Cutting Parameters ※ P422

UP100-R4

4 Flute Corner Radius

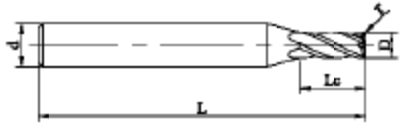

Fig1

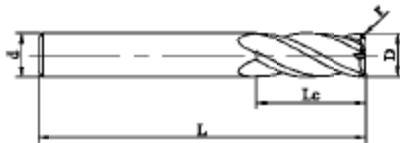

Fig2



See page 97 for guidelines to icons

Ordering Code	D	Lc	r	L	d	Figure No.	Stock
UP100-R4-12030	12	30	3	75	12	2	○
UP100-R4-16005	16	36	0.5	100	16	2	○
UP100-R4-16010	16	36	1	100	16	2	○
UP100-R4-16020	16	36	2	100	16	2	○
UP100-R4-16030	16	36	3	100	16	2	○

●Stock ○Available upon Order

D	Tol
D 12	$\begin{matrix} 0 \\ -0.02 \end{matrix}$
D > 12	$\begin{matrix} 0 \\ -0.03 \end{matrix}$

unit(mm)

Workpiece Material						
P		M	K	N		
1234	5	123	123	123	4	5
Carbon Steel, Alloy Steel(<35 HRC)	Alloy Steel, Tool Steel(<48HRC)	Stainless Steel	Cast Iron	Aluminium Alloys	Copper Alloys	Graphite
⊙	○	○	⊙	○	○	

⊙ Most Suitable ○ Suitable

Cutting Parameters ※ P422

UP100-RH4

4 Flute Corner Radius, with Long Shank Length

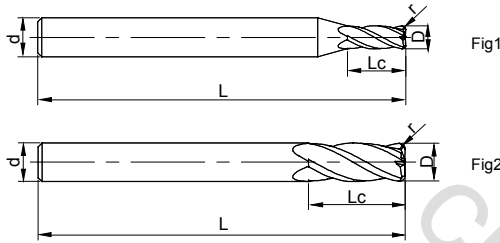

See page 97 for guidelines to icons

Ordering Code	D	Lc	r	L	d	Figure No.	Stock
UP100-RH4-06005	6	16	0.5	75	6	2	○
UP100-RH4-06010	6	16	1	75	6	2	○
UP100-RH4-08005	8	20	0.5	100	8	2	○
UP100-RH4-08010	8	20	1	100	8	2	○
UP100-RH4-08015	8	20	1.5	100	8	2	○
UP100-RH4-08020	8	20	2	100	8	2	○
UP100-RH4-10005	10	25	0.5	100	10	2	○
UP100-RH4-10010	10	25	1	100	10	2	○
UP100-RH4-10015	10	25	1.5	100	10	2	○
UP100-RH4-10020	10	25	2	100	10	2	○

● Stock ○ Available upon Order

D	Tol
D 12	$\begin{matrix} 0 \\ -0.02 \end{matrix}$
D > 12	$\begin{matrix} 0 \\ -0.03 \end{matrix}$

unit(mm)

Workpiece Material

P		M	K	N		
1234	5	123	123	123	4	5
Carbon Steel, Alloy Steel(<35 HRC)	Alloy Steel, Tool Steel(<48HRC)	Stainless Steel	Cast Iron	Aluminium Alloys	Copper Alloys	Graphite
⊙	○	○	⊙	○	○	

⊙ Most Suitable ○ Suitable

Cutting Parameters ※ P422

UP100-RH4

4 Flute Corner Radius, with Long Shank Length

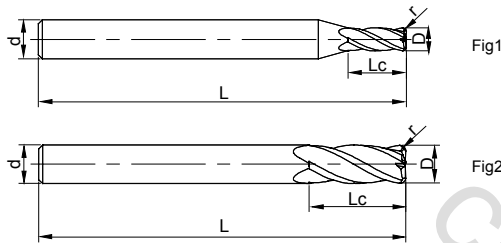

See page 97 for guidelines to icons

Ordering Code	D	Lc	r	L	d	Figure No.	Stock
UP100-RH4-12005	12	30	0.5	100	12	2	○
UP100-RH4-12010	12	30	1	100	12	2	○
UP100-RH4-12015	12	30	1.5	100	12	2	○
UP100-RH4-12020	12	30	2	100	12	2	○
UP100-RH4-12030	12	30	3	100	12	2	○
UP100-RH4-16005	16	36	0.5	150	16	2	○
UP100-RH4-16010	16	36	1	150	16	2	○
UP100-RH4-16015	16	36	1.5	150	16	2	○
UP100-RH4-16020	16	36	2	150	16	2	○
UP100-RH4-16030	16	36	3	150	16	2	○

● Stock ○ Available upon Order

D	Tol
D 12	$\begin{matrix} 0 \\ -0.02 \end{matrix}$
D > 12	$\begin{matrix} 0 \\ -0.03 \end{matrix}$

unit(mm)

Workpiece Material						
P		M	K	N		
1234	5	123	123	123	4	5
Carbon Steel, Alloy Steel(<35 HRC)	Alloy Steel, Tool Steel(<48HRC)	Stainless Steel	Cast Iron	Aluminium Alloys	Copper Alloys	Graphite
◎	○	○	◎	○	○	

◎ Most Suitable ○ Suitable

Cutting Parameters ※ P422

UP210-R2

2 Flute Corner Radius

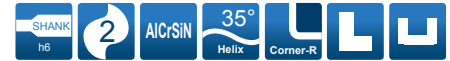
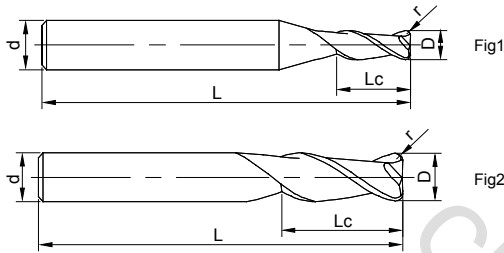

See page 97 for guidelines to icons

Ordering Code	D	Lc	r	L	d	Figure No.	Stock
UP210-R2-01002	1	3	0.2	50	4	1	●
UP210-R2-01502	1.5	5	0.2	50	4	1	○
UP210-R2-02002	2	6	0.2	50	4	1	●
UP210-R2-03002	3	9	0.2	50	4	1	●
UP210-R2-63002	3	9	0.2	50	6	1	○
UP210-R2-03003	3	9	0.3	50	4	1	●
UP210-R2-63003	3	9	0.3	50	6	1	○
UP210-R2-03005	3	9	0.5	50	4	1	●
UP210-R2-63005	3	9	0.5	50	6	1	○
UP210-R2-04002	4	11	0.2	50	4	2	●
UP210-R2-64002	4	11	0.2	50	6	1	○
UP210-R2-04003	4	11	0.3	50	4	2	●
UP210-R2-64003	4	11	0.3	50	6	1	○
UP210-R2-04005	4	11	0.5	50	4	2	●
UP210-R2-64005	4	11	0.5	50	6	1	○
UP210-R2-04010	4	11	1	50	4	2	○

●Stock ○Available upon Order

D	Tol
D 12	0 -0.02
D > 12	0 -0.03

unit(mm)

Workpiece Material						
P		M	K	N		
1234	5	123	123	123	4	5
Carbon Steel, Alloy Steel(<35 HRC)	Alloy Steel, Tool Steel(<48HRC)	Stainless Steel	Cast Iron	Aluminium Alloys	Copper Alloys	Graphite
⊙	○	○	⊙	○	○	

⊙ Most Suitable ○ Suitable

Cutting Parameters ※ P425

UP210-R2

2 Flute Corner Radius

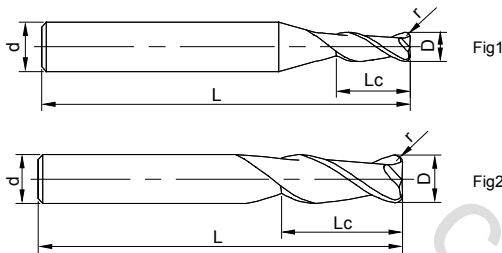

See page 97 for guidelines to icons

» continue

Ordering Code	D	Lc	r	L	d	Figure No.	Stock
UP210-R2-05002	5	13	0.2	50	6	1	○
UP210-R2-05003	5	13	0.3	50	6	1	○
UP210-R2-05005	5	13	0.5	50	6	1	●
UP210-R2-05010	5	13	1	50	6	1	○
UP210-R2-06005	6	16	0.5	50	6	2	●
UP210-R2-06010	6	16	1	50	6	2	○
UP210-R2-06015	6	16	1.5	50	6	2	○
UP210-R2-06020	6	16	2	50	6	2	○
UP210-R2-08003	8	20	0.3	60	8	2	○
UP210-R2-08005	8	20	0.5	60	8	2	●
UP210-R2-08010	8	20	1	60	8	2	●
UP210-R2-08015	8	20	1.5	60	8	2	●
UP210-R2-08020	8	20	2	60	8	2	○
UP210-R2-10003	10	25	0.3	75	10	2	○
UP210-R2-10005	10	25	0.5	75	10	2	●
UP210-R2-10010	10	25	1	75	10	2	●
UP210-R2-10015	10	25	1.5	75	10	2	○

● Stock ○ Available upon Order

D	Tol
D ≤ 12	0 -0.02
D > 12	0 -0.03

unit(mm)

Workpiece Material						
P		M	K	N		
1234	5	123	123	123	4	5
Carbon Steel, Alloy Steel(<35 HRC)	Alloy Steel, Tool Steel(<48HRC)	Stainless Steel	Cast Iron	Aluminium Alloys	Copper Alloys	Graphite
◎	◎	○	◎			

◎ Most Suitable ○ Suitable

Cutting Parameters ※ P425

UP210-R2

2 Flute Corner Radius

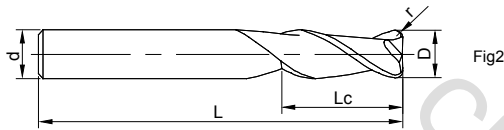
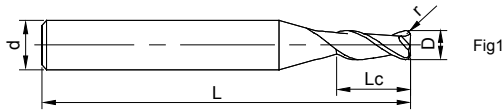

See page 97 for guidelines to icons

» continue

Ordering Code	D	Lc	r	L	d	Figure No.	Stock
UP210-R2-10020	10	25	2	75	10	2	●
UP210-R2-10030	10	25	3	75	10	2	○
UP210-R2-12005	12	30	0.5	75	12	2	●
UP210-R2-12010	12	30	1	75	12	2	●
UP210-R2-12015	12	30	1.5	75	12	2	○
UP210-R2-12020	12	30	2	75	12	2	●
UP210-R2-12030	12	30	3	75	12	2	○
UP210-R2-14010	14	32	1	100	14	2	○
UP210-R2-14020	14	32	2	100	14	2	○
UP210-R2-16005	16	36	0.5	100	16	2	○
UP210-R2-16010	16	36	1	100	16	2	●
UP210-R2-16020	16	36	2	100	16	2	○
UP210-R2-16030	16	36	3	100	16	2	○
UP210-R2-18010	18	40	1	100	18	2	○
UP210-R2-18020	18	40	2	100	18	2	○
UP210-R2-20010	20	45	1	100	20	2	○
UP210-R2-20020	20	45	2	100	20	2	○

● Stock ○ Available upon Order

D	Tol
D 12	0 -0.02
D > 12	0 -0.03

unit(mm)

Workpiece Material						
P		M	K	N		
1234	5	123	123	123	4	5
Carbon Steel, Alloy Steel(<35 HRC)	Alloy Steel, Tool Steel(<48HRC)	Stainless Steel	Cast Iron	Aluminium Alloys	Copper Alloys	Graphite
⊙	⊙	○	⊙			

⊙ Most Suitable ○ Suitable

Cutting Parameters ※ P425

UP210-RH2

2 Flute Corner Radius, with Long Shank Length

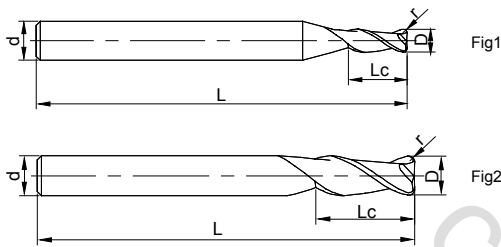

See page 97 for guidelines to icons

Ordering Code	D	Lc	r	L	d	Figure No.	Stock
UP210-RH2-06005	6	16	0.5	75	6	2	●
UP210-RH2-06010	6	16	1	75	6	2	○
UP210-RH2-06015	6	16	1.5	75	6	2	○
UP210-RH2-08005	8	20	0.5	100	8	2	●
UP210-RH2-08010	8	20	1	100	8	2	○
UP210-RH2-08015	8	20	1.5	100	8	2	○
UP210-RH2-10005	10	25	0.5	100	10	2	●
UP210-RH2-10010	10	25	1	100	10	2	●
UP210-RH2-10015	10	25	1.5	100	10	2	○
UP210-RH2-10020	10	25	2	100	10	2	○
UP210-RH2-12005	12	30	0.5	100	12	2	○
UP210-RH2-12010	12	30	1	100	12	2	●
UP210-RH2-12015	12	30	1.5	100	12	2	○
UP210-RH2-12020	12	30	2	100	12	2	○
UP210-RH2-14010	14	36	1	150	14	2	○
UP210-RH2-14020	14	36	2	150	14	2	○

● Stock ○ Available upon Order

D	Tol
D 12	0 -0.02
D > 12	0 -0.03

unit(mm)

Workpiece Material						
P		M	K	N		
1234	5	123	123	123	4	5
Carbon Steel, Alloy Steel(<35 HRC)	Alloy Steel, Tool Steel(<48HRC)	Stainless Steel	Cast Iron	Aluminium Alloys	Copper Alloys	Graphite
⊙	⊙	○	⊙			

● Most Suitable ○ Suitable

Cutting Parameters ※ P425

UP210-RH2

2 Flute Corner Radius, with Long Shank Length

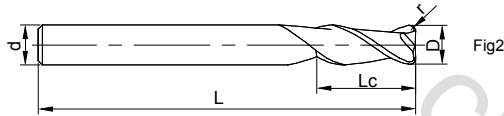
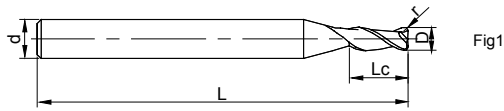

See page 97 for guidelines to icons

» continue

Ordering Code	D	Lc	r	L	d	Figure No.	Stock
UP210-RH2-16005	16	36	0.5	150	16	2	○
UP210-RH2-16010	16	36	1	150	16	2	●
UP210-RH2-16015	16	36	1.5	150	16	2	○
UP210-RH2-16020	16	36	2	150	16	2	○
UP210-RH2-18010	18	45	1	150	18	2	○
UP210-RH2-18020	18	45	2	150	18	2	○
UP210-RH2-20010	20	45	1	150	20	2	○
UP210-RH2-20020	20	45	2	150	20	2	○

●Stock ○Available upon Order

D	Tol
D 12	0 -0.02
D > 12	0 -0.03

unit(mm)

Workpiece Material						
P		M	K	N		
1234	5	123	123	123	4	5
Carbon Steel, Alloy Steel(<35 HRC)	Alloy Steel, Tool Steel(<48HRC)	Stainless Steel	Cast Iron	Aluminium Alloys	Copper Alloys	Graphite
⊙	⊙	○	⊙			

⊙ Most Suitable ○ Suitable

Cutting Parameters ※ P425

UP210-R4

4 Flute Corner Radius

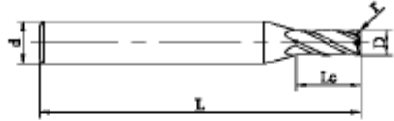

Fig1

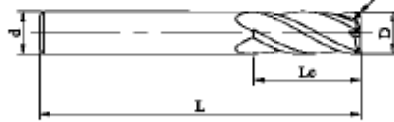

Fig2



See page 97 for guidelines to icons

Ordering Code	D	Lc	r	L	d	Figure No.	Stock
UP210-R4-01502	1.5	5	0.2	50	4	1	●
UP210-R4-02002	2	6	0.2	50	4	1	●
UP210-R4-03002	3	9	0.2	50	4	1	●
UP210-R4-03003	3	9	0.3	50	4	1	○
UP210-R4-03005	3	9	0.5	50	4	1	●
UP210-R4-04002	4	11	0.2	50	4	2	●
UP210-R4-04003	4	11	0.3	50	4	2	○
UP210-R4-04005	4	11	0.5	50	4	2	●
UP210-R4-04010	4	11	1	50	4	2	●
UP210-R4-04510	4.5	12	1	50	6	1	○
UP210-R4-05002	5	13	0.2	50	6	1	○
UP210-R4-05005	5	13	0.5	50	6	1	●
UP210-R4-05010	5	13	1	50	6	1	●
UP210-R4-05015	5	13	1.5	50	6	1	○
UP210-R4-06002	6	16	0.2	50	6	2	○
UP210-R4-06005	6	16	0.5	50	6	2	●

● Stock ○ Available upon Order

D	Tol
D ≤ 12	0 -0.02
D > 12	0 -0.03

unit (mm)

Workpiece Material						
P		M	K	N		
1234	5	123	123	123	4	5
Carbon Steel, Alloy Steel(<35 HRC)	Alloy Steel, Tool Steel(<48HRC)	Stainless Steel	Cast Iron	Aluminium Alloys	Copper Alloys	Graphite
⊙	⊙	○	⊙			

⊙ Most Suitable ○ Suitable

Cutting Parameters ※ P426

UP210-R4

4 Flute Corner Radius

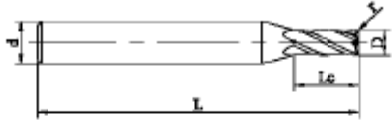

Fig1

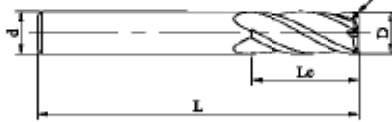

Fig2



See page 97 for guidelines to icons

» continue

Ordering Code	D	Lc	r	L	d	Figure No.	Stock
UP210-R4-06010	6	16	1	50	6	2	●
UP210-R4-06015	6	16	1.5	50	6	2	●
UP210-R4-08003	8	20	0.3	60	8	2	○
UP210-R4-08005	8	20	0.5	60	8	2	●
UP210-R4-08010	8	20	1	60	8	2	●
UP210-R4-08015	8	20	1.5	60	8	2	●
UP210-R4-08020	8	20	2	60	8	2	●
UP210-R4-10002	10	25	0.2	75	10	2	○
UP210-R4-10003	10	25	0.3	75	10	2	○
UP210-R4-10005	10	25	0.5	75	10	2	●
UP210-R4-10010	10	25	1	75	10	2	●
UP210-R4-10015	10	25	1.5	75	10	2	●
UP210-R4-10020	10	25	2	75	10	2	○
UP210-R4-10025	10	25	2.5	75	10	2	○
UP210-R4-10030	10	25	3	75	10	2	○
UP210-R4-12005	12	30	0.5	75	12	2	●

●Stock ○Available upon Order

D	Tol
D 12	0 -0.02
D > 12	0 -0.03

unit (mm)

Workpiece Material						
P		M	K	N		
1234	5	123	123	123	4	5
Carbon Steel, Alloy Steel(<35 HRC)	Alloy Steel, Tool Steel(<48HRC)	Stainless Steel	Cast Iron	Aluminium Alloys	Copper Alloys	Graphite
⊙	⊙	○	⊙			

⊙ Most Suitable ○ Suitable

Cutting Parameters ※ P426

UP210-R4

4 Flute Corner Radius

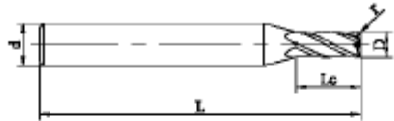

Fig1

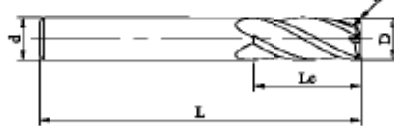

Fig2



See page 97 for guidelines to icons

» continue

Ordering Code	D	Lc	r	L	d	Figure No.	Stock
UP210-R4-12010	12	30	1	75	12	2	●
UP210-R4-12015	12	30	1.5	75	12	2	○
UP210-R4-12020	12	30	2	75	12	2	●
UP210-R4-12025	12	30	2.5	75	12	2	○
UP210-R4-12030	12	30	3	75	12	2	●
UP210-R4-14010	14	32	1	100	14	2	○
UP210-R4-14020	14	32	2	100	14	2	○
UP210-R4-16005	16	36	0.5	100	16	2	●
UP210-R4-16010	16	36	1	100	16	2	●
UP210-R4-16020	16	36	2	100	16	2	●
UP210-R4-16030	16	36	3	100	16	2	●
UP210-R4-18010	18	40	1	100	18	2	○
UP210-R4-18020	18	40	2	100	18	2	○
UP210-R4-20010	20	45	1	100	20	2	○
UP210-R4-20020	20	45	2	100	20	2	○

● Stock ○ Available upon Order

D	Tol
D 12	0 -0.02
D > 12	0 -0.03

unit (mm)

Workpiece Material						
P		M	K	N		
1234	5	123	123	123	4	5
Carbon Steel, Alloy Steel(<35 HRC)	Alloy Steel, Tool Steel(<48HRC)	Stainless Steel	Cast Iron	Aluminium Alloys	Copper Alloys	Graphite
⊙	⊙	○	⊙			

⊙ Most Suitable ○ Suitable

Cutting Parameters ※ P426

UP210-RH4

4 Flute Corner Radius, with Long Shank Length

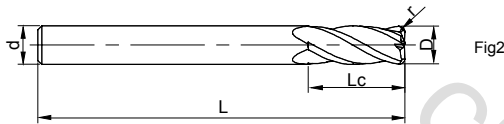
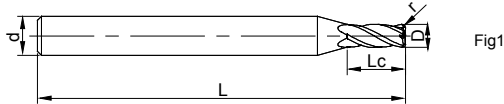

See page 97 for guidelines to icons

Ordering Code	D	Lc	r	L	d	Figure No.	Stock
UP210-RH4-06005	6	16	0.5	75	6	2	●
UP210-RH4-06010	6	16	1	75	6	2	●
UP210-RH4-06015	6	16	1.5	75	6	2	○
UP210-RH4-08005	8	20	0.5	100	8	2	●
UP210-RH4-08010	8	20	1	100	8	2	●
UP210-RH4-08015	8	20	1.5	100	8	2	○
UP210-RH4-08020	8	20	2	100	8	2	○
UP210-RH4-10005	10	25	0.5	100	10	2	●
UP210-RH4-10010	10	25	1	100	10	2	●
UP210-RH4-10015	10	25	1.5	100	10	2	○
UP210-RH4-10020	10	25	2	100	10	2	●
UP210-RH4-12005	12	30	0.5	100	12	2	●
UP210-RH4-12010	12	30	1	100	12	2	●
UP210-RH4-12015	12	30	1.5	100	12	2	○
UP210-RH4-12020	12	30	2	100	12	2	○
UP210-RH4-12030	12	30	3	100	12	2	○

● Stock ○ Available upon Order

D	Tol
D 12	0 -0.02
D > 12	0 -0.03

unit (mm)

Workpiece Material						
P		M	K	N		
1234	5	123	123	123	4	5
Carbon Steel, Alloy Steel(<35 HRC)	Alloy Steel, Tool Steel(<48HRC)	Stainless Steel	Cast Iron	Aluminium Alloys	Copper Alloys	Graphite
⊙	⊙	○	⊙			

⊙ Most Suitable ○ Suitable

Cutting Parameters ※ P426

UP210-RH4

4 Flute Corner Radius, with Long Shank Length

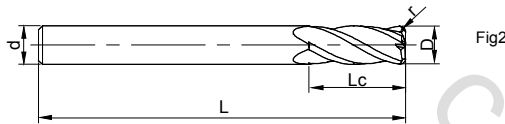
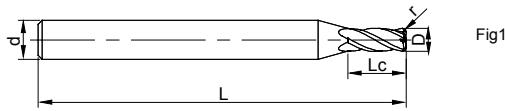

See page 97 for guidelines to icons

» continue

Ordering Code	D	Lc	r	L	d	Figure No.	Stock
UP210-RH4-14010	14	36	1	150	14	2	○
UP210-RH4-14020	14	36	2	150	14	2	○
UP210-RH4-16005	16	36	0.5	150	16	2	○
UP210-RH4-16010	16	36	1	150	16	2	●
UP210-RH4-16015	16	36	1.5	150	16	2	○
UP210-RH4-16020	16	36	2	150	16	2	○
UP210-RH4-16030	16	36	3	150	16	2	○
UP210-RH4-18010	18	45	1	150	18	2	○
UP210-RH4-18020	18	45	2	150	18	2	○
UP210-RH4-20010	20	45	1	150	20	2	●
UP210-RH4-20020	20	45	2	150	20	2	○

● Stock ○ Available upon Order

D	Tol
D 12	0 -0.02
D > 12	0 -0.03

unit (mm)

Workpiece Material						
P		M	K	N		
1234	5	123	123	123	4	5
Carbon Steel, Alloy Steel(<35 HRC)	Alloy Steel, Tool Steel(<48HRC)	Stainless Steel	Cast Iron	Aluminium Alloys	Copper Alloys	Graphite
⊙	⊙	○	⊙			

⊙ Most Suitable ○ Suitable

Cutting Parameters ※ P426

SP210-R4

4 Flute Comer Radius, with Variable Helix

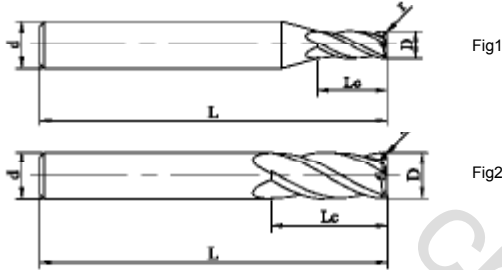

See page 97 for guidelines to icons

Ordering Code	DV	Lc	r	L	d	Figure No.	Stock
SP210-R4-03003	3	9	0.3	50	4	1	○
SP210-R4-03005	3	9	0.5	50	4	1	●
SP210-R4-04003	4	11	0.3	50	4	2	●
SP210-R4-04005	4	11	0.5	50	4	2	●
SP210-R4-05003	5	13	0.3	50	6	1	○
SP210-R4-05005	5	13	0.5	50	6	1	●
SP210-R4-06003	6	16	0.3	50	6	2	○
SP210-R4-06005	6	16	0.5	50	6	2	●
SP210-R4-06010	6	16	1	50	6	2	●
SP210-R4-06015	6	16	1.5	50	6	2	○
SP210-R4-08005	8	20	0.5	60	8	2	●
SP210-R4-08010	8	20	1.0	60	8	2	●
SP210-R4-08015	8	20	1.5	60	8	2	○
SP210-R4-08020	8	20	2	60	8	2	○
SP210-R4-10005	10	25	0.5	75	10	2	●
SP210-R4-10010	10	25	1	75	10	2	●

●Stock ○Available upon Order

D	Tol
D 12	0 -0.02
D > 12	0 -0.03

unit(mm)

Workpiece Material						
P		M	K	N		
1234	5	123	123	123	4	5
Carbon Steel, Alloy Steel(<35 HRC)	Alloy Steel, Tool Steel(<48HRC)	Stainless Steel	Cast Iron	Aluminium Alloys	Copper Alloys	Graphite
⊙	⊙	○	⊙			

⊙ Most Suitable ○ Suitable

Cutting Parameters ※ P429

SP210-R4

4 Flute Comer Radius, with Variable Helix

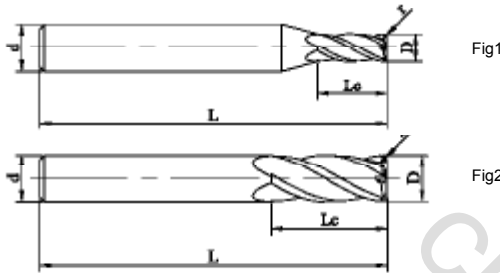

See page 97 for guidelines to icons

» continue

Ordering Code	D	Le	r	L	d	Figure No.	Stock
SP210-R4-10015	10	25	1.5	75	10	2	○
SP210-R4-10020	10	25	2	75	10	2	●
SP210-R4-10030	10	25	3	75	10	2	●
SP210-R4-12005	12	30	0.5	75	12	2	○
SP210-R4-12010	12	30	1	75	12	2	●
SP210-R4-12015	12	30	1.5	75	12	2	○
SP210-R4-12020	12	30	2	75	12	2	○
SP210-R4-12030	12	30	3	75	12	2	○
SP210-R4-14020	14	32	2	75	14	2	○
SP210-R4-16020	16	36	2	100	16	2	○

● Stock ○ Available upon Order

D	Tol
D 12	0 -0.02
D > 12	0 -0.03

unit(mm)

Workpiece Material						
P		M	K	N		
1234	5	123	123	123	4	5
Carbon Steel, Alloy Steel(<35 HRC)	Alloy Steel, Tool Steel(<48HRC)	Stainless Steel	Cast Iron	Aluminium Alloys	Copper Alloys	Graphite
◎	◎	○	◎			

◎ Most Suitable ○ Suitable

Cutting Parameters ※ P429

US200-R2

2 Flute Corner Radius

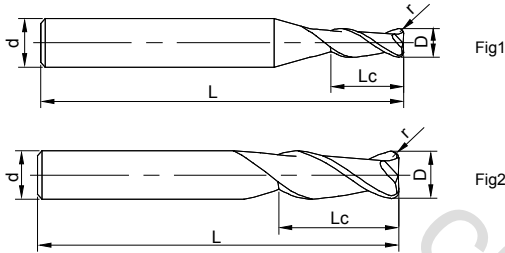

See page 97 for guidelines to icons

Ordering Code	D	Lc	r	L	d	Figure No.	Stock
US200-R2-03003	3	9	0.3	50	4	1	●
US200-R2-03005	3	9	0.5	50	4	1	○
US200-R2-04002	4	11	0.2	50	4	2	●
US200-R2-64002	4	11	0.2	50	6	1	●
US200-R2-04003	4	11	0.3	50	4	2	●
US200-R2-64003	4	11	0.3	50	6	1	●
US200-R2-64005	4	11	0.5	50	6	1	●
US200-R2-05002	5	13	0.2	50	6	1	●
US200-R2-05003	5	13	0.3	50	6	1	●
US200-R2-05005	5	13	0.5	50	6	1	●
US200-R2-06002	6	16	0.2	50	6	2	●
US200-R2-06003	6	16	0.3	50	6	2	●
US200-R2-06005	6	16	0.5	50	6	2	○

●Stock ○Available upon Order

D	Tol
D 12	$\begin{matrix} 0 \\ -0.02 \end{matrix}$
D > 12	$\begin{matrix} 0 \\ -0.03 \end{matrix}$

unit (mm)

Workpiece Material

P		M	K	S	
1234	5	123	123	123	4
Carbon Steel, Alloy Steel (< 35HRC)	Alloy Steel, Tool Steel (<48HRC)	Stainless Steel	Cast Iron	Heat-resistant Alloys	Titanium Alloys
○	○	⊙	○	○	○

⊙ Most Suitable ○ Suitable

Cutting Parameters ※ P437

US200-R2

2 Flute Corner Radius

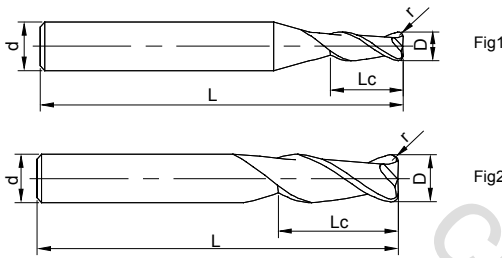

See page 97 for guidelines to icons

» continue

Ordering Code	D	Lc	r	L	d	Figure No.	Stock
US200-R2-08005	8	20	0.5	60	8	2	○
US200-R2-08010	8	20	1	60	8	2	●
US200-R2-10005	10	25	0.5	75	10	2	○
US200-R2-10010	10	25	1	75	10	2	●
US200-R2-10015	10	25	1.5	75	10	2	○
US200-R2-12005	12	30	0.5	75	12	2	○
US200-R2-12010	12	30	1	75	12	2	○
US200-R2-12015	12	30	1.5	75	12	2	●
US200-R2-16005	16	36	0.5	100	16	2	○
US200-R2-16010	16	36	1	100	16	2	○
US200-R2-16020	16	36	2	100	16	2	●
US200-R2-16030	16	36	3	100	16	2	○

● Stock ○ Available upon Order

D	Tol
D 12	0 -0.02
D > 12	0 -0.03

unit (mm)

Workpiece Material					
P	M	K	S		
1234	5	123	123	123	4
Carbon Steel, Alloy Steel (< 35HRC)	Alloy Steel, Tool Steel (<48HRC)	Stainless Steel	Cast Iron	Heat-resistant Alloys	Titanium Alloys
○	○	⊙	○	○	○

● Most Suitable ○ Suitable

Cutting Parameters ※ P437

US200-R3

3 Flute Corner Radius

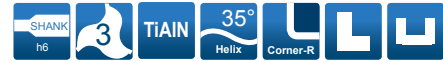
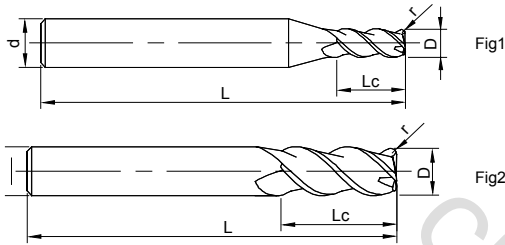

See page 97 for guidelines to icons

Ordering Code	D	Lc	r	L	d	Figure No.	Stock
US200-R3-02001	2	6	0.1	50	4	1	●
US200-R3-02002	2	6	0.2	50	4	1	○
US200-R3-04002	4	11	0.2	50	4	2	○
US200-R3-04005	4	11	0.5	50	4	2	●
US200-R3-06002	6	16	0.2	50	6	2	○
US200-R3-06005	6	16	0.5	50	6	2	●
US200-R3-08005	8	20	0.5	60	8	2	○
US200-R3-08010	8	20	1	60	8	2	●
US200-R3-10005	10	25	0.5	75	10	2	○
US200-R3-10010	10	25	1	75	10	2	●
US200-R3-10015	10	25	1.5	75	10	2	●
US200-R3-10020	10	25	2	75	10	2	●

● Stock ○ Available upon Order

D	Tol
D 12	$\begin{matrix} 0 \\ -0.02 \end{matrix}$
D > 12	$\begin{matrix} 0 \\ -0.03 \end{matrix}$

unit (mm)

Workpiece Material

P		M	K	S	
1234	5	123	123	123	4
Carbon Steel, Alloy Steel (< 35HRC)	Alloy Steel, Tool Steel (<48HRC)	Stainless Steel	Cast Iron	Heat-resistant Alloys	Titanium Alloys
○	○	⊙	○	○	○

● Most Suitable ○ Suitable

Cutting Parameters ※ P437

US200-R3

3 Flute Corner Radius

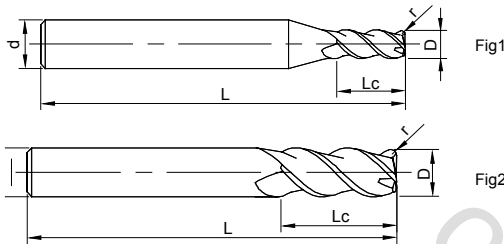

See page 97 for guidelines to icons

» continue

Ordering Code	D	Lc	r	L	d	Figure No.	Stock
US200-R3-12005	12	30	0.5	75	12	2	○
US200-R3-12010	12	30	1	75	12	2	●
US200-R3-12015	12	30	1.5	75	12	2	●
US200-R3-16005	16	36	0.5	100	16	2	●
US200-R3-16010	16	36	1	100	16	2	●
US200-R3-16020	16	36	2	100	16	2	●
US200-R3-16030	16	36	3	100	16	2	●
US200-R3-20005	20	45	0.5	100	20	2	●
US200-R3-20010	20	45	1	100	20	2	●
US200-R3-20020	20	45	2	100	20	2	●
US200-R3-20040	20	45	4	100	20	2	●

● Stock ○ Available upon Order

D	Tol
D 12	0 -0.02
D > 12	0 -0.03

unit (mm)

Workpiece Material

P		M	K	S	
1234	5	123	123	123	4
Carbon Steel, Alloy Steel (< 35HRC)	Alloy Steel, Tool Steel (<48HRC)	Stainless Steel	Cast Iron	Heat-resistant Alloys	Titanium Alloys
○	○	⊙	○	○	○

● Most Suitable ○ Suitable

Cutting Parameters ※ P437

US200-R4

4 Flute Corner Radius

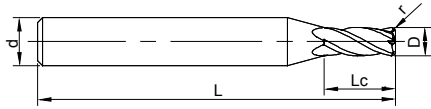

Fig1

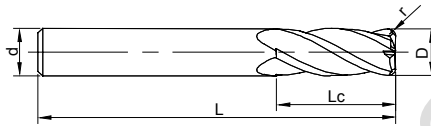
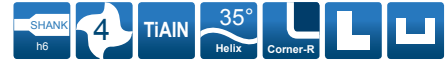

Fig2



See page 97 for guidelines to icons

Ordering Code	D	Lc	r	L	d	Figure No.	Stock
US200-R4-02002	2	6	0.2	50	4	1	●
US200-R4-03003	3	9	0.3	50	4	1	●
US200-R4-03005	3	9	0.5	50	4	1	●
US200-R4-64002	4	11	0.2	50	6	1	●
US200-R4-64003	4	11	0.3	50	6	1	●
US200-R4-04003	4	11	0.3	50	4	2	●
US200-R4-04005	4	11	0.5	50	4	2	○
US200-R4-05005	5	13	0.5	50	6	1	●
US200-R4-06005	6	16	0.5	50	6	2	●

● Stock ○ Available upon Order

D	Tol
D 12	0 -0.02
D > 12	0 -0.03

unit (mm)

Workpiece Material

P		M	K	S	
1234	5	123	123	123	4
Carbon Steel, Alloy Steel (< 35HRC)	Alloy Steel, Tool Steel (<48HRC)	Stainless Steel	Cast Iron	Heat-resistant Alloys	Titanium Alloys
○	○	⊙	○	○	○

● Most Suitable ○ Suitable

Cutting Parameters ※ P438

US200-R4

4 Flute Corner Radius

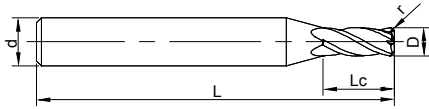

Fig1

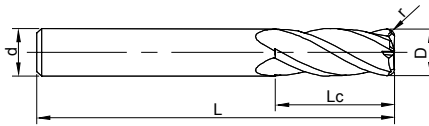

Fig2



See page 97 for guidelines to icons

» continue

Ordering Code	D	Lc	r	L	d	Figure No.	Stock
US200-R4-08002	8	20	0.2	60	8	2	●
US200-R4-08005	8	20	0.5	60	8	2	●
US200-R4-08010	8	20	1	60	8	2	●
US200-R4-10005	10	25	0.5	75	10	2	●
US200-R4-10010	10	25	1	75	10	2	●
US200-R4-12010	12	30	1	75	12	2	●
US200-R4-16010	16	36	1	100	16	2	○
US200-R4-20010	20	45	1	100	20	2	○
US200-RS4-06005	6	5	0.5	50	6	2	●

● Stock ○ Available upon Order

D	Tol
D = 12	$\begin{matrix} 0 \\ -0.02 \end{matrix}$
D > 12	$\begin{matrix} 0 \\ -0.03 \end{matrix}$

unit (mm)

Workpiece Material

P		M	K	S	
1234	5	123	123	123	4
Carbon Steel, Alloy Steel (< 35HRC)	Alloy Steel, Tool Steel (<48HRC)	Stainless Steel	Cast Iron	Heat-resistant Alloys	Titanium Alloys
○	○	⊙	○	○	○

● Most Suitable ○ Suitable

Cutting Parameters ※ P438

UA100-R2

2 Flute Corner Radius

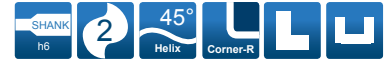
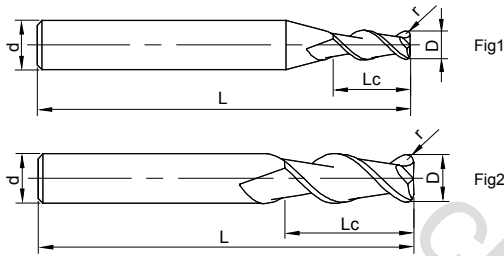

See page 97 for guidelines to icons

Ordering Code	D	Lc	r	L	d	Figure No.	Stock
UA100-R2-01001	1	3	0.1	50	4	1	○
UA100-R2-02002	2	6	0.2	50	4	1	●
UA100-R2-03002	3	9	0.2	50	4	1	●
UA100-R2-03003	3	9	0.3	50	4	1	●
UA100-R2-63003	3	9	0.3	50	6	1	●
UA100-R2-03005	3	9	0.5	50	4	1	●
UA100-R2-63005	3	9	0.5	50	6	1	●
UA100-R2-04002	4	11	0.2	50	4	2	○
UA100-R2-04003	4	11	0.3	50	4	2	●
UA100-R2-64003	4	11	0.3	50	6	1	●
UA100-R2-04005	4	11	0.5	50	4	2	●
UA100-R2-64005	4	11	0.5	50	6	1	●
UA100-R2-04010	4	11	1	50	4	2	●
UA100-R2-05002	5	13	0.2	50	6	1	●
UA100-R2-05003	5	13	0.3	50	6	1	●
UA100-R2-05005	5	13	0.5	50	6	1	●

●Stock ○Available upon Order

D	Tol
D ≤ 12	0 -0.02
D > 12	0 -0.03

unit (mm)

Workpiece Material						
P		M	K	N		
1234	5	123	123	123	4	5
Carbon Steel, Alloy Steel(< 35HRC)	Alloy Steel, Tool Steel(<48HRC)	Stainless Steel	Cast Iron	Aluminium Alloys	Copper Alloys	Graphite
				⊙	⊙	

⊙ Most Suitable ○ Suitable

Cutting Parameters ※ P441

UA100-R2

2 Flute Corner Radius

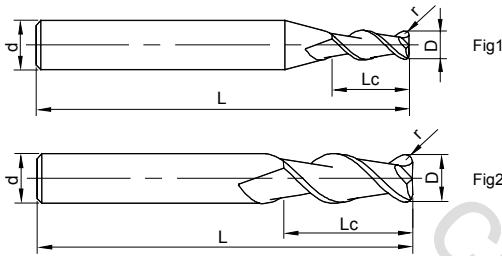

See page 97 for guidelines to icons

Ordering Code	D	Lc	r	L	d	Figure No.	Stock
UA100-R2-05010	5	13	1	50	6	1	●
UA100-R2-05015	5	13	1.5	50	6	1	●
UA100-R2-06005	6	16	0.5	50	6	2	○
UA100-R2-06010	6	16	1	50	6	2	●
UA100-R2-06015	6	16	1.5	50	6	2	●
UA100-R2-06020	6	16	2	50	6	2	●
UA100-R2-08005	8	20	0.5	60	8	2	●
UA100-R2-08010	8	20	1	60	8	2	●
UA100-R2-08015	8	20	1.5	60	8	2	●
UA100-R2-08020	8	20	2	60	8	2	●
UA100-R2-10005	10	25	0.5	75	10	2	●
UA100-R2-10010	10	25	1	75	10	2	●
UA100-R2-10015	10	25	1.5	75	10	2	●
UA100-R2-10020	10	25	2	75	10	2	●
UA100-R2-10025	10	25	2.5	75	10	2	●
UA100-R2-12005	12	30	0.5	75	12	2	●

●Stock ○Available upon Order

D	Tol
D 12	$\begin{matrix} 0 \\ -0.02 \end{matrix}$
D > 12	$\begin{matrix} 0 \\ -0.03 \end{matrix}$

unit (mm)

Workpiece Material						
P		M	K	N		
1234	5	123	123	123	4	5
Carbon Steel, Alloy Steel(< 35HRC)	Alloy Steel, Tool Steel(<48HRC)	Stainless Steel	Cast Iron	Aluminium Alloys	Copper Alloys	Graphite
				⊙	⊙	

● Most Suitable ○ Suitable

Cutting Parameters ※ P441

UA100-R2

2 Flute Corner Radius

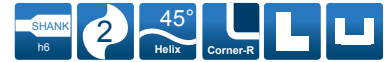
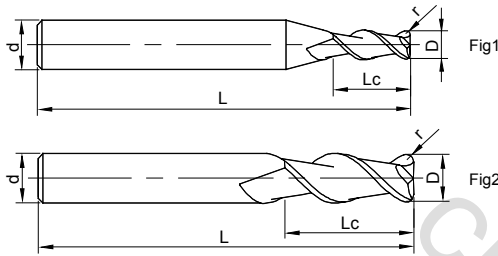

See page 97 for guidelines to icons

» continue

Ordering Code	D	Lc	r	L	d	Figure No.	Stock
UA100-R2-12010	12	30	1	75	12	2	●
UA100-R2-12015	12	30	1.5	75	12	2	●
UA100-R2-12020	12	30	2	75	12	2	●
UA100-R2-12025	12	30	2.5	75	12	2	●
UA100-R2-16005	16	36	0.5	100	16	2	●
UA100-R2-16010	16	36	1	100	16	2	●
UA100-R2-16015	16	36	1.5	100	16	2	●
UA100-R2-16020	16	36	2	100	16	2	●
UA100-R2-16025	16	36	2.5	100	16	2	●
UA100-R2-20005	20	45	0.5	100	20	2	●
UA100-R2-20010	20	45	1	100	20	2	●
UA100-R2-20015	20	45	1.5	100	20	2	●
UA100-R2-20020	20	45	2	100	20	2	●
UA100-R2-20030	20	45	3	100	20	2	●

●Stock ○Available upon Order

D	Tol
D 12	$\begin{matrix} 0 \\ -0.02 \end{matrix}$
D > 12	$\begin{matrix} 0 \\ -0.03 \end{matrix}$

unit (mm)

Workpiece Material						
P		M	K	N		
1234	5	123	123	123	4	5
Carbon Steel, Alloy Steel(< 35HRC)	Alloy Steel, Tool Steel(<48HRC)	Stainless Steel	Cast Iron	Aluminium Alloys	Copper Alloys	Graphite
				⊙	⊙	

● Most Suitable ○ Suitable

Cutting Parameters ※ P441

UA100-RH2

2 Flute Corner Radius, with Long Shank Length

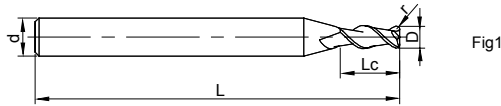

Fig1

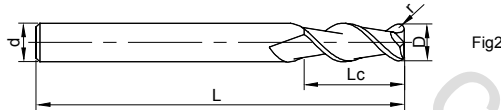
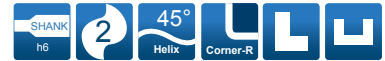

Fig2



See page 97 for guidelines to icons

Ordering Code	D	Lc	r	L	d	Figure No.	Stock
UA100-RH2-06005	6	16	0.5	75	6	2	○
UA100-RH2-06010	6	16	1	75	6	2	○
UA100-RH2-06015	6	16	1.5	75	6	2	●
UA100-RH2-06020	6	16	2	75	6	2	●
UA100-RH2-08005	8	20	0.5	100	8	2	○
UA100-RH2-08010	8	20	1	100	8	2	●
UA100-RH2-08015	8	20	1.5	100	8	2	○
UA100-RH2-08020	8	20	2	100	8	2	○
UA100-RH2-10005	10	25	0.5	100	10	2	○
UA100-RH2-10010	10	25	1	100	10	2	○
UA100-RH2-10015	10	25	1.5	100	10	2	●
UA100-RH2-10020	10	25	2	100	10	2	●
UA100-RH2-10025	10	25	2.5	100	10	2	●
UA100-RH2-12005	12	30	0.5	100	12	2	●

●Stock ○Available upon Order

D	Tol
D 12	$\begin{matrix} 0 \\ -0.02 \end{matrix}$
D > 12	$\begin{matrix} 0 \\ -0.03 \end{matrix}$

unit (mm)

Workpiece Material						
P		M	K	N		
1234	5	123	123	123	4	5
Carbon Steel, Alloy Steel(< 35HRC)	Alloy Steel, Tool Steel(<48HRC)	Stainless Steel	Cast Iron	Aluminium Alloys	Copper Alloys	Graphite
				⊙	⊙	

● Most Suitable ○ Suitable

Cutting Parameters ※ P441

UA100-RH2

2 Flute Corner Radius, with Long Shank Length

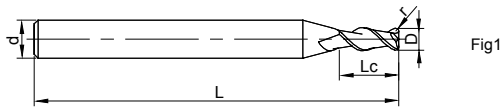

Fig1

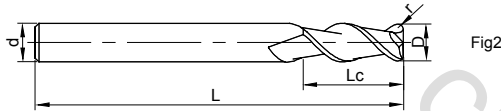
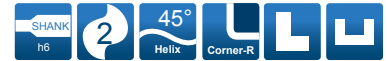

Fig2



See page 97 for guidelines to icons

» continue

Ordering Code	D	Lc	r	L	d	Figure No.	Stock
UA100-RH2-12010	12	30	1	100	12	2	●
UA100-RH2-12015	12	30	1.5	100	12	2	●
UA100-RH2-12020	12	30	2	100	12	2	●
UA100-RH2-12025	12	30	2.5	100	12	2	●
UA100-RH2-16005	16	36	0.5	150	16	2	●
UA100-RH2-16010	16	36	1	150	16	2	●
UA100-RH2-16015	16	36	1.5	150	16	2	●
UA100-RH2-16020	16	36	2	150	16	2	●
UA100-RH2-16025	16	36	2.5	150	16	2	●
UA100-RH2-20005	20	45	0.5	150	20	2	●
UA100-RH2-20010	20	45	1	150	20	2	●
UA100-RH2-20015	20	45	1.5	150	20	2	●
UA100-RH2-20020	20	45	2	150	20	2	●
UA100-RH2-20030	20	45	3	150	20	2	●

●Stock ○Available upon Order

D	Tol
D 12	0 -0.02
D > 12	0 -0.03

unit (mm)

Workpiece Material

P		M	K	N		
1234	5	123	123	123	4	5
Carbon Steel, Alloy Steel(< 35HRC)	Alloy Steel, Tool Steel(<48HRC)	Stainless Steel	Cast Iron	Aluminium Alloys	Copper Alloys	Graphite
				⊙	⊙	

● Most Suitable ○ Suitable

Cutting Parameters ※ P441

UA100-R3

3 Flute Corner Radius

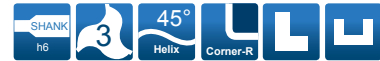
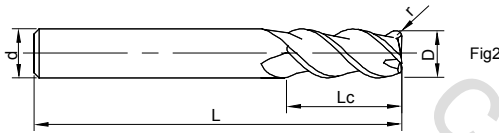
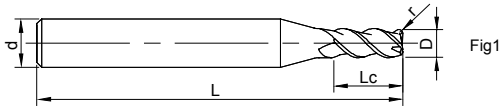

See page 97 for guidelines to icons

Ordering Code	D	Lc	r	L	d	Figure No.	Stock
UA100-R3-01001	1	3	0.1	50	4	1	○
UA100-R3-02002	2	6	0.2	50	4	1	○
UA100-R3-03002	3	9	0.2	50	4	1	○
UA100-R3-03003	3	9	0.3	50	4	1	○
UA100-R3-03005	3	9	0.5	50	4	1	○
UA100-R3-04002	4	11	0.2	50	4	2	○
UA100-R3-04003	4	11	0.3	50	4	2	○
UA100-R3-04005	4	11	0.5	50	4	2	○
UA100-R3-04010	4	11	1	50	4	2	○
UA100-R3-05002	5	13	0.2	50	6	1	○
UA100-R3-05003	5	13	0.3	50	6	1	○
UA100-R3-05005	5	13	0.5	50	6	1	○
UA100-R3-05010	5	13	1	50	6	1	○

●Stock ○Available upon Order

D	Tol
D 12	0 -0.02
D > 12	0 -0.03

unit (mm)

Workpiece Material						
P		M	K	N		
1234	5	123	123	123	4	5
Carbon Steel, Alloy Steel (< 35HRC)	Alloy Steel, Tool Steel (<48HRC)	Stainless Steel	Cast Iron	Aluminium Alloys	Copper Alloys	Graphite
				⊙	⊙	

● Most Suitable ○ Suitable

Cutting Parameters ※ P442

UA100-R3

3 Flute Corner Radius

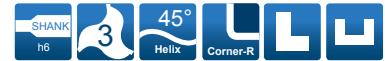
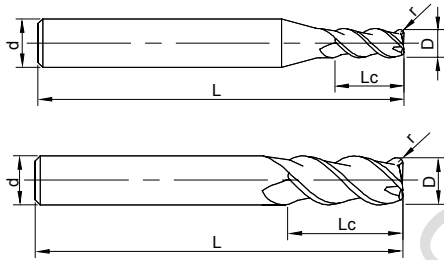

See page 97 for guidelines to icons

» continue

Ordering Code	D	Lc	r	L	d	Figure No.	Stock
UA100-R3-06005	6	16	0.5	50	6	2	●
UA100-R3-06010	6	16	1	50	6	2	●
UA100-R3-06015	6	16	1.5	50	6	2	●
UA100-R3-06020	6	16	2	50	6	2	●
UA100-R3-08005	8	20	0.5	60	8	2	●
UA100-R3-08010	8	20	1	60	8	2	●
UA100-R3-08015	8	20	1.5	60	8	2	●
UA100-R3-08020	8	20	2	60	8	2	●
UA100-R3-10005	10	25	0.5	75	10	2	●
UA100-R3-10010	10	25	1	75	10	2	●
UA100-R3-10015	10	25	1.5	75	10	2	●
UA100-R3-10020	10	25	2	75	10	2	●
UA100-R3-10025	10	25	2.5	75	10	2	●

● Stock ○ Available upon Order

D	Tol
D 12	0 -0.02
D > 12	0 -0.03

unit (mm)

Workpiece Material

P		M	K	N		
1234	5	123	123	123	4	5
Carbon Steel, Alloy Steel (< 35HRC)	Alloy Steel, Tool Steel (<48HRC)	Stainless Steel	Cast Iron	Aluminium Alloys	Copper Alloys	Graphite
				⊙	⊙	

⊙ Most Suitable ○ Suitable

Cutting Parameters ※ P442

UA100-R3

3 Flute Corner Radius

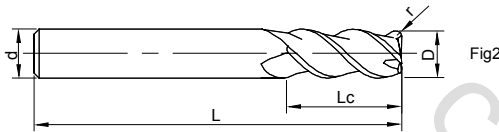
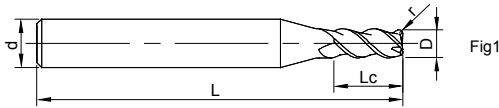

See page 97 for guidelines to icons

» continue

Ordering Code	D	Lc	r	L	d	Figure No.	Stock
UA100-R3-12005	12	30	0.5	75	12	2	●
UA100-R3-12010	12	30	1	75	12	2	○
UA100-R3-12015	12	30	1.5	75	12	2	●
UA100-R3-12020	12	30	2	75	12	2	●
UA100-R3-12025	12	30	2.5	75	12	2	●
UA100-R3-16005	16	36	0.5	100	16	2	○
UA100-R3-16010	16	36	1	100	16	2	●
UA100-R3-16015	16	36	1.5	100	16	2	●
UA100-R3-16020	16	36	2	100	16	2	●
UA100-R3-16025	16	36	2.5	100	16	2	●
UA100-R3-20005	20	45	0.5	100	20	2	●
UA100-R3-20010	20	45	1	100	20	2	●
UA100-R3-20015	20	45	1.5	100	20	2	○
UA100-R3-20020	20	45	2	100	20	2	●
UA100-R3-20030	20	45	3	100	20	2	○

● Stock ○ Available upon Order

D	Tol
D 12	0 -0.02
D > 12	0 -0.03

unit (mm)

Workpiece Material						
P		M	K	N		
1234	5	123	123	123	4	5
Carbon Steel, Alloy Steel (< 35HRC)	Alloy Steel, Tool Steel (<48HRC)	Stainless Steel	Cast Iron	Aluminium Alloys	Copper Alloys	Graphite
				⊙	⊙	

● Most Suitable ○ Suitable

Cutting Parameters ※ P442

UA100-RH3

3 Flute Corner Radius, with Long Shank Length

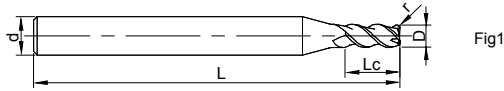

Fig1

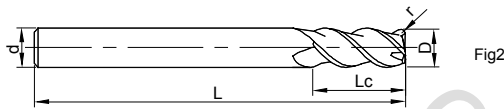
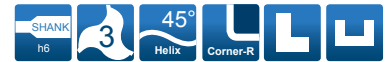

Fig2



See page 97 for guidelines to icons

To1

Ordering Code	D	Lc	r	L	d	Figure No.	Stock
UA100-RH3-06005	6	16	0.5	75	6	2	●
UA100-RH3-06010	6	16	1	75	6	2	○
UA100-RH3-06015	6	16	1.5	75	6	2	●
UA100-RH3-06020	6	16	2	75	6	2	●
UA100-RH3-08005	8	20	0.5	100	8	2	○
UA100-RH3-08010	8	20	1	100	8	2	○
UA100-RH3-08015	8	20	1.5	100	8	2	○
UA100-RH3-08020	8	20	2	100	8	2	○
UA100-RH3-10005	10	25	0.5	100	10	2	○
UA100-RH3-10010	10	25	1	100	10	2	●
UA100-RH3-10015	10	25	1.5	100	10	2	●
UA100-RH3-10020	10	25	2	100	10	2	●
UA100-RH3-10025	10	25	2.5	100	10	2	●

●Stock ○Available upon Order

D	公差
D 12	0 -0.02
D > 12	0 -0.03

unit (mm)

Workpiece Material

P		M	K	N		
1234	5	123	123	123	4	5
Carbon Steel, Alloy Steel (< 35HRC)	Alloy Steel, Tool Steel (<48HRC)	Stainless Steel	Cast Iron	Aluminium Alloys	Copper Alloys	Graphite
				⊙	⊙	

⊙ Most Suitable ○ Suitable

Cutting Parameters ※ P442

UA100-RH3

3 Flute Corner Radius, with Long Shank Length

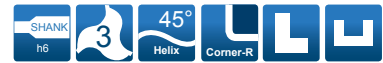
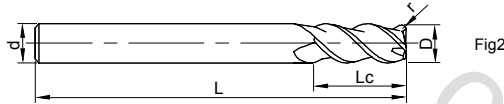
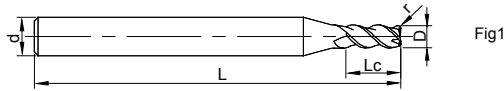

See page 97 for guidelines to icons

» continue

Ordering Code	D	Lc	r	L	d	Figure No.	Stock
UA100-RH3-12005	12	30	0.5	100	12	2	○
UA100-RH3-12010	12	30	1	100	12	2	●
UA100-RH3-12015	12	30	1.5	100	12	2	●
UA100-RH3-12020	12	30	2	100	12	2	●
UA100-RH3-12025	12	30	2.5	100	12	2	●
UA100-RH3-16005	16	36	0.5	150	16	2	●
UA100-RH3-16010	16	36	1	150	16	2	●
UA100-RH3-16015	16	36	1.5	150	16	2	●
UA100-RH3-16020	16	36	2	150	16	2	○
UA100-RH3-16025	16	36	2.5	150	16	2	●
UA100-RH3-20005	20	45	0.5	150	20	2	○
UA100-RH3-20010	20	45	1	150	20	2	●
UA100-RH3-20015	20	45	1.5	150	20	2	●
UA100-RH3-20020	20	45	2	150	20	2	●
UA100-RH3-20030	20	45	3	150	20	2	●

● Stock ○ Available upon Order

D	Tol
D 12	0 -0.02
D > 12	0 -0.03

unit (mm)

Workpiece Material						
P		M	K	N		
1234	5	123	123	123	4	5
Carbon Steel, Alloy Steel (< 35HRC)	Alloy Steel, Tool Steel (<48HRC)	Stainless Steel	Cast Iron	Aluminium Alloys	Copper Alloys	Graphite
				⊙	⊙	

● Most Suitable ○ Suitable

Cutting Parameters ※ P442

SA300-RN2

2 Flute Corner Radius, with Reduced Neck

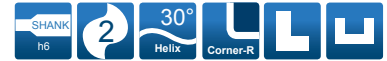
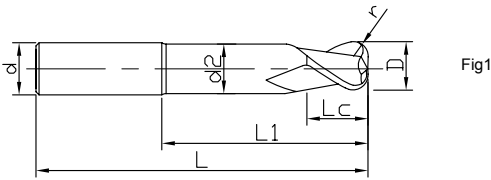

See page 97 for guidelines to icons

Ordering Code	D	r	Lc	L1	d2	L	d	Figure No.	Stock
SA300-RN2-10010	10	1	12	32	9.5	72	10	1	○
SA300-RN2-12010	12	1	14	42	11	87	12	1	○
SA300-RN2-12030	12	3	14	42	11	87	12	1	○
SA300-RN2-16010	16	1	18	52	15	100	16	1	○
SA300-RN2-16030	16	3	18	52	15	100	16	1	○
SA300-RN2-20030	20	3	24	62	19	112	20	1	○

●Stock ○Available upon Order

D	Tol
D 12	0 -0.02
D > 12	0 -0.03

unit (mm)

Workpiece Material						
P		M	K	N		
1234	5	123	123	123	4	5
Carbon Steel, Alloy Steel (< 35HRC)	Alloy Steel, Tool Steel (<48HRC)	Stainless Steel	Cast Iron	Aluminium Alloys	Copper Alloys	Graphite
				⊙	⊙	

● Most Suitable ○ Suitable

Cutting Parameters ※ P446

SA300-RN3

2 FluteCorner Radius, with Reduced Neck

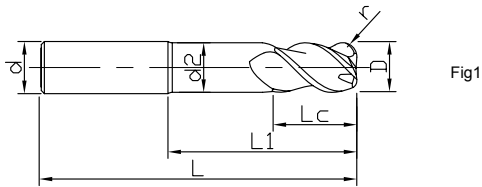

See page 97 for guidelines to icons

Ordering Code	D	r	Lc	L1	d2	L	d	Figure No.	Stock
SA300-RN3-12010	12	1	14	50	11	95	12	1	○
SA300-RN3-12030	12	3	14	50	11	95	12	1	○
SA300-RN3-16010	16	1	18	52	15	100	16	1	○
SA300-RN3-16030	16	3	18	52	15	100	16	1	○
SA300-RN3-20030	20	3	24	62	19	112	20	1	○

●Stock ○Available upon Order

D	Tol
D 12	0 -0.02
D > 12	0 -0.03

unit (mm)

Workpiece Material						
P		M	K	N		
1234	5	123	123	123	4	5
Carbon Steel, Alloy Steel (< 35HRC)	Alloy Steel, Tool Steel (<48HRC)	Stainless Steel	Cast Iron	Aluminium Alloys	Copper Alloys	Graphite
				⊙	⊙	

● Most Suitable ○ Suitable

Cutting Parameters ※ P447

SA310-RN2

2 Flute Corner Radius, with Reduced Neck

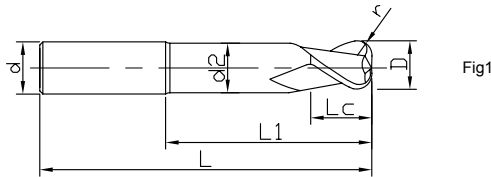

See page 97 for guidelines to icons

Ordering Code	D	r	Lc	L1	d2	L	d	Figure No.	Stock
SA310-RN2-10010	10	1	12	32	9.5	72	10	1	○
SA310-RN2-12010	12	1	14	42	11	87	12	1	○
SA310-RN2-12030	12	3	14	42	11	87	12	1	○
SA310-RN2-16010	16	1	18	52	15	100	16	1	○
SA310-RN2-16030	16	3	18	52	15	100	16	1	○
SA310-RN2-20030	20	3	24	62	19	112	20	1	○
SA310-RN2-20050	20	5	24	62	19	112	20	1	○
SA310-RN2-25030	25	3	30	62	24	118	25	1	○
SA310-RN2-32030	32	3	30	62	31	122	32	1	○

● Stock ○ Available upon Order

D	Tol
D 12	0 -0.02
D > 12	0 -0.03

unit (mm)

Workpiece Material						
P		M	K	N		
1234	5	123	123	123	4	5
Carbon Steel, Alloy steel (< 35HRC)	Alloy steel, Tool steel (< HRC48)	Stainless Steel	Cast Iron	Aluminium Alloys	Copper Alloys	Graphite
				⊙	⊙	

● Most Suitable ○ Suitable

Cutting Parameters ※ P448

SA310-RN3

3 Flute Corner Radius, with Reduced Neck

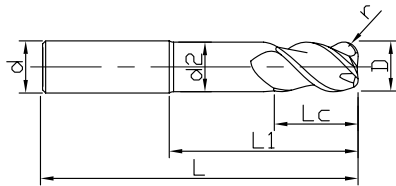

Fig1



See page 97 for guidelines to icons

Ordering Code	D	r	Lc	L1	d2	L	d	Figure No.	Stock
SA310-RN3-12005	12	05	14	50	11.5	95	12	1	○
SA310-RN3-12030	12	3	14	50	11.5	95	12	1	○
SA310-RN3-16010	16	1	18	52	15	100	16	1	○
SA310-RN3-16030	16	3	18	52	15	100	16	1	○
SA310-RN3-20030	20	3	30	60	19	110	20	1	○
SA310-RN3-25030	25	3	30	62	24	118	25	1	○

●Stock ○Available upon Order

D	Tol
D 12	0 -0.02
D > 12	0 -0.03

unit (mm)

Workpiece Material

P		M	K	N		
1234	5	123	123	123	4	5
Carbon Steel, Alloy steel (< 35HRC)	Alloy steel, Tool steel (<HRC48)	Stainless Steel	Cast Iron	Aluminium Alloys	Copper Alloys	Graphite
				⊙	⊙	

● Most Suitable ○ Suitable

Cutting Parameters ※ P448

SA360-RN2

2 FluteCorner Radius, with Reduced Neck Internal Coolant

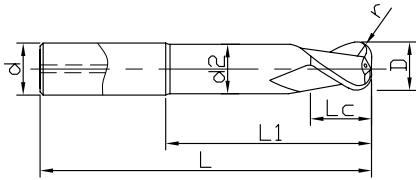
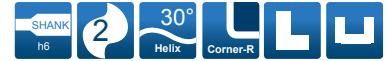

Fig1



See page 97 for guidelines to icons

Ordering Code	D	r	Lc	L1	d2	L	d	Figure No.	Stock
SA360-RN2-12030	12	3	26	40	11.5	90	12	1	○
SA360-RN2-16030	16	3	30	50	15	100	16	1	○
SA360-RN2-16050	16	5	30	50	15	100	16	1	○
SA360-RN2-20005	20	0.5	30	60	19	110	20	1	○
SA360-RN2-20030	20	3	30	60	19	110	20	1	○
SA360-RN2-20050	20	5	30	60	19	110	20	1	○
SA360-RN2-25030	25	3	30	60	24	115	25	1	○
SA360-RN2-25050	25	5	30	60	24	115	25	1	○

●Stock ○Available upon Order

D	Tol
D 12	0 -0.02
D > 12	0 -0.03

unit (mm)

Workpiece Material

P		M	K	N		
1234	5	123	123	123	4	5
Carbon Steel, Alloy steel (< 35HRC)	Alloy steel, Tool steel (<HRC48)	Stainless Steel	Cast Iron	Aluminium Alloys	Copper Alloys	Graphite
				⊙	⊙	

● Most Suitable ○ Suitable

Cutting Parameters ※ P448

SG200-R2

2 Flute, Corner Radius

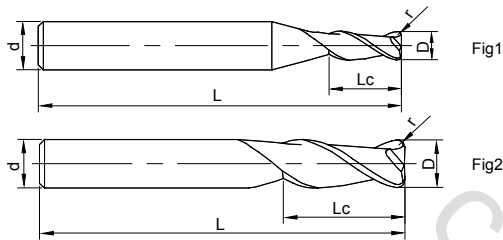

See page 97 for guidelines to icons

Ordering Code	D	Lc	r	L	d	Figure No.	Stock
SG200-R2-02002	2	3.5	0.2	50	4	1	○
SG200-R2-03002	3	4	0.2	50	4	1	○
SG200-R2-04005	4	5	0.5	50	4	2	●
SG200-R2-05005	5	6	0.5	50	6	1	○
SG200-R2-06003	6	9	0.3	50	6	2	○
SG200-R2-06005	6	9	0.5	50	6	2	○
SG200-R2-08005	8	12	0.5	60	8	2	○
SG200-R2-08010	8	12	1	60	8	2	○
SG200-R2-10005	10	15	0.5	75	10	2	○
SG200-R2-10010	10	15	1	75	10	2	○
SG200-R2-10015	10	15	1.5	75	10	2	○
SG200-R2-12005	12	18	0.5	75	12	2	○
SG200-R2-12010	12	18	1	75	12	2	○
SG200-R2-12015	12	18	1.5	75	12	2	○

●Stock ○Available upon Order

D	Tol
D < 6	0 -0.02
6 ≤ D ≤ 12	0 -0.03

unit (mm)

Workpiece Material						
P		M	K	N		
1234	5	123	123	123	4	5
Carbon Steel, Alloy steel (< 35HRC)	Alloy steel, Tool steel (<HRC48)	Stainless Steel	Cast Iron	Aluminium Alloys	Copper Alloys	Graphite
				○	○	◎

◎ Most Suitable ○ Suitable

Cutting Parameters ※ P449

SG200-RN2

2 Flute Corner Radius, with Reduced Neck

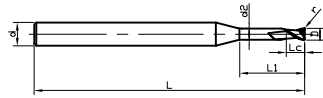

Fig1

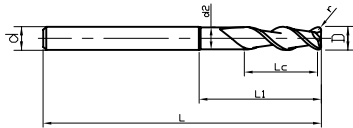

Fig2



See page 97 for guidelines to icons

Ordering Code	D	r	Lc	L1	d1	L	d	Figure No.	Stock
SG200-RN2-02002	2	0.2	3.5	6	1.92	50	4	1	●
SG200-RN2-02003	2	0.3	3.5	6	1.92	50	4	1	○
SG200-RN2-02005	2	0.5	3.5	6	1.92	50	4	1	○
SG200-RN2-03002	3	0.2	4	10	2.9	50	4	1	○
SG200-RN2-03003	3	0.3	4	10	2.9	50	4	1	○
SG200-RN2-03005	3	0.5	4	10	2.9	50	4	1	○
SG200-RN2-04002	4	0.2	5	15	3.9	50	4	2	○
SG200-RN2-04005	4	0.5	5	15	3.9	50	4	2	●
SG200-RN2-04010	4	1	5	15	3.9	50	4	2	○
SG200-RN2-05002	5	0.2	6	15	4.9	75	6	1	○
SG200-RN2-05005	5	0.5	6	15	4.9	75	6	1	○
SG200-RN2-06002	6	0.2	7	20	5.9	75	6	2	○
SG200-RN2-06005	6	0.5	7	20	5.9	75	6	2	●
SG200-RN2-06010	6	1	7	20	5.9	75	6	2	○

● Stock ○ Available upon Order

D	Tol
D < 6	0 -0.02
6 ≤ D ≤ 12	0 -0.03

unit (mm)

Workpiece Material						
P		M	K	N		
1234	5	123	123	123	4	5
CarbonSteel, Alloy Steel (< 35HRC)	AlloySteel, Tool Steel(35-48HRC)	Stainless Steel	Cast Iron	Aluminium Alloys	Copper Alloys	Graphite
				○	○	◎

◎ Most Suitable ○ Suitable

Cutting Parameters ※ P449

SG200-R4

4 Flute, Corner Radius

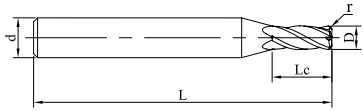

Fig1

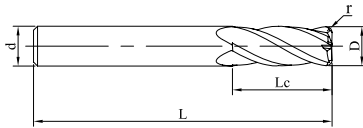

Fig2



See page 97 for guidelines to icons

Ordering Code	D	r	Lc	L	d	Figure No.	Stock
SG200-R4-02002	2	3.5	0.2	50	4	1	○
SG200-R4-03002	3	4	0.2	50	4	1	○
SG200-R4-04002	4	6	0.2	50	4	2	○
SG200-R4-04010	4	6	1	50	4	2	●
SG200-R4-05003	5	7	0.3	50	6	1	○
SG200-R4-06005	6	9	0.5	50	6	2	●
SG200-R4-06010	6	9	1	50	6	2	○
SG200-R4-08005	8	12	0.5	60	8	2	○
SG200-R4-08010	8	12	1	60	8	2	○
SG200-R4-10005	10	15	0.5	75	10	2	●
SG200-R4-10010	10	15	1	75	10	2	○
SG200-R4-12005	12	18	0.5	75	12	2	○
SG200-R4-12010	12	18	1	75	12	2	○

●Stock ○Available upon Order

D	Tol
D < 6	0 -0.02
6 D 12	0 -0.03

unit (mm)

Workpiece Material						
P		M	K	N		
1234	5	123	123	123	4	5
CarbonSteel, Alloy Steel (< 35HRC)	AlloySteel, Tool Steel(35-48HRC)	Stainless Steel	Cast Iron	Aluminium Alloys	Copper Alloys	Graphite
				○	○	◎

● Most Suitable ○ Suitable

Cutting Parameters ※ P449

SG200-RN4

4 Flute Corner Radius, with Reduced Neck

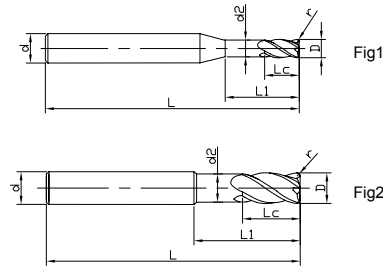

See page 97 for guidelines to icons

Ordering Code	D	r	Lc	L1	d1	L	d	Figure No.	Stock
SG200-RN4-02002	2	0.2	3.5	6	1.92	50	4	1	○
SG200-RN4-03002	3	0.2	4	10	2.9	50	4	1	○
SG200-RN4-03003	3	0.3	4	20	2.9	50	4	1	○
SG200-RN4-04005	4	0.5	6	20	3.9	50	4	2	●
SG200-RN4-04010	4	1	6	20	3.9	50	4	2	○
SG200-RN4-06005	6	0.5	9	25	5.9	75	6	2	●
SG200-RN4-06010	6	1	9	25	5.9	75	6	2	○
SG200-RN4-08005	8	0.5	12	30	7.9	100	8	2	○
SG200-RN4-08010	8	1	12	30	7.9	100	8	2	○
SG200-RN4-10005	10	0.5	15	45	9.8	100	10	2	○
SG200-RN4-10010	10	1	15	35	9.8	100	10	2	●
SG200-RN4-12005	12	0.5	18	40	11.8	100	12	2	○
SG200-RN4-12010	12	1	18	40	11.8	100	12	2	○

● Stock ○ Available upon Order

D	Tol
D < 6	0 -0.02
6 ≤ D ≤ 12	0 -0.03

unit (mm)

Workpiece Material						
	P	M	K		N	
1234	5	123	123	123	4	5
CarbonSteel, Alloy Steel (< 35HRC)	AlloySteel, Tool Steel(35-48HRC)	Stainless Steel	Cast Iron	Aluminium Alloys	Copper Alloys	Graphite
				○	○	◎

◎ Most Suitable ○ Suitable

Cutting Parameters ※ P449

SN200-R4

4 Flute Corner Radius, with variable Helix

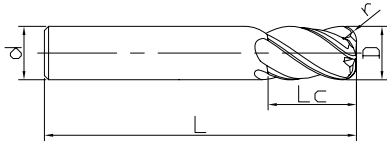

Fig1



See page 97 for guidelines to icons

Ordering Code	D	r	Lc	L	d	Figure No.	Stock
SN200-R4-06005	6	0.5	15	50	6	1	○
SN200-R4-08010	8	1	19	63	8	1	○
SN200-R4-10010	10	1	22	72	10	1	○
SN200-R4-12010	12	1	26	83	12	1	○
SN200-R4-16010	16	1	32	92	16	1	○
SN200-R4-18010	18	1	32	92	18	1	○

●Stock ○Available upon Order

D	Tol
D 12	0 -0.03
D > 12	0 -0.04

unit (mm)

Workpiece Material				
P		M	S	
1 2 3 4	5	1 2 3	1 2 3	4
Carbon Steel, Alloy Steel (< 35HRC)	Alloy Steel, Tool Steel (35-48HRC)	Stainless Steel	Heat-resistant Super Alloys	Titanium Alloys
○	○	○	⊙	○

● Most Suitable ○ Suitable

Cutting Parameters ※ P452

ST200-R4

4 Flute Corner Radius, with variable Helix

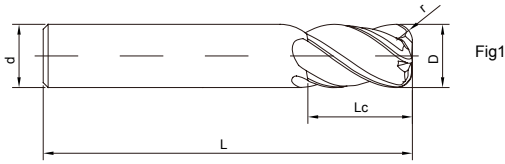

See page 97 for guidelines to icons

Ordering Code	D	r	Lc	L	d	Figure No.	Stock
ST200-R4-06005	6	0.5	15	50	6	1	●
ST200-R4-06010	6	1	15	50	6	1	●
ST200-R4-08005	8	0.5	20	60	8	1	●
ST200-R4-08010	8	1	20	60	8	1	●
ST200-R4-10010	10	1	25	75	10	1	○
ST200-R4-10030	10	3	25	75	10	1	○
ST200-R4-12010	12	1	30	75	12	1	○
ST200-R4-12030	12	3	30	75	12	1	○
ST200-R4-16010	16	1	36	100	16	1	○
ST200-R4-16030	16	3	36	100	16	1	○

● Stock ○ Available upon Order

D	Tol
D 16	0 -0.03
D > 16	0 -0.04

unit (mm)

Workpiece Material				
P		M	S	
1 2 3 4	5	1 2 3	1 2 3	4
Carbon Steel, Alloy steel (< 35HRC)	Alloy steel , Tool steel (< 48HRC)	Stainless Steel	Heat-resistant Alloys	Titanium Alloys
○	○	⊙	○	⊙

● Most Suitable ○ Suitable

Cutting Parameters ※ P454

ST200-RN4

4 FluteCorner Radius, with Reduced Neckvariable Helix

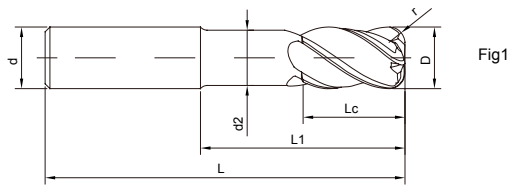

See page 97 for guidelines to icons

Ordering Code	D	r	Lc	L1	d2	L	d	Figure No.	Stock
ST200-RN4-12010	12	1	24	36	11	90	12	1	○
ST200-RN4-12030	12	3	24	36	11	90	12	1	●
ST200-RN4-16010	16	1	32	47	15	100	16	1	○
ST200-RN4-16030	16	3	32	47	15	100	16	1	○
ST200-RN4-20010	20	1	40	57	19	115	20	1	○
ST200-RN4-20030	20	3	40	57	19	115	20	1	○
ST200-RN4-25030	25	3	50	65	24	130	25	1	○

● Stock ○ Available upon Order

D	Tol
D 16	0 -0.03
D > 16	0 -0.04

unit (mm)

Workpiece Material				
P		M	S	
1 2 3 4	5	1 2 3	1 2 3	4
Carbon Steel, Alloy steel (< 35HRC)	Alloy steel, Tool steel (< 48HRC)	Stainless Steel	Heat-resistant Alloys	Titanium Alloys
○	○	⊙	○	⊙

● Most Suitable ○ Suitable

Cutting Parameters ※ P454

ST200-RN5

5 Flute Corner Radius, with Reduced Neck variable Helix

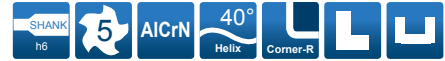
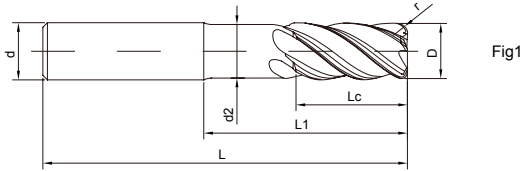

See page 97 for guidelines to icons

Ordering Code	D	r	Lc	L1	d2	L	d	Figure No.	Stock
ST200-RN5-16010	16	1	32	45	15	100	16	1	○
ST200-RN5-20010	20	1	40	60	19	112	20	1	○
ST200-RN5-20020	20	2	40	60	19	112	20	1	○
ST200-RN5-20030	20	3	40	60	19	112	20	1	○
ST200-RN5-20040	20	4	40	60	19	112	20	1	○
ST200-RN5-25030	25	3	50	65	24	130	25	1	○

● Stock ○ Available upon Order

D	Tol
D 16	$\frac{0}{-0.03}$
D > 16	$\frac{0}{-0.04}$

unit (mm)

Workpiece Material				
P		M	S	
1 2 3 4	5	1 2 3	1 2 3	4
Carbon Steel, Alloy steel (< 35HRC)	Alloy steel, Tool steel (< 48HRC)	Stainless Steel	Heat-resistant Alloys	Titanium Alloys
○	○	⊙	○	⊙

● Most Suitable ○ Suitable

Cutting Parameters ※ P455

ST200-RL5

5 Flute Corner Radius, with Long Flute Lengthvariable Helix

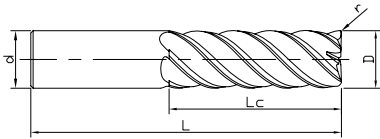

Fig1



See page 97 for guidelines to icons

Ordering Code	D	r	Lc	L	d	Figure No.	Stock
ST200-RL5-16005	16	0.5	48	100	16	1	○
ST200-RL5-16005A	16	0.5	80	130	16	1	○
ST200-RL5-20005	20	0.5	60	110	20	1	○
ST200-RL5-20005A	20	0.5	100	150	20	1	○
ST200-RL5-25005	25	0.5	75	155	25	1	○
ST200-RL5-25005A	25	0.5	125	205	25	1	○

●Stock ○Available upon Order

D	Tol
D 16	$\begin{matrix} 0 \\ -0.03 \end{matrix}$
D > 16	$\begin{matrix} 0 \\ -0.04 \end{matrix}$

unit (mm)

Workpiece Material				
P		M	S	
1 2 3 4	5	1 2 3	1 2 3	4
Carbon Steel, Alloy steel (< 35HRC)	Alloy steel, Tool steel (< 48HRC)	Stainless Steel	Heat-resistant Alloys	Titanium Alloys
○	○	◎	○	◎

● Most Suitable ○ Suitable

Cutting Parameters ※ P455

ST260-RN4

4 Flute Corner Radius, with Reduced Neck variable Helix, Internal Coolant

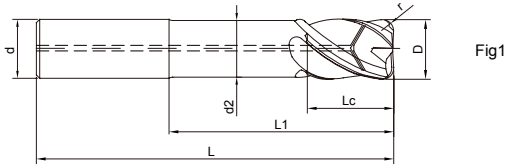

See page 97 for guidelines to icons

Ordering Code	D	r	Lc	L1	d2	L	d	Figure No.	Stock
ST260-RN4-12010	12	1	24	36	11	90	12	1	○
ST260-RN4-12030	12	3	24	36	11	90	12	1	○
ST260-RN4-16010	16	1	32	47	15	100	16	1	○
ST260-RN4-16030	16	3	32	47	15	100	16	1	○
ST260-RN4-20030	20	3	40	57	19	115	20	1	○
ST260-RN4-25050	25	5	50	65	24	130	25	1	○

● Stock ○ Available upon Order

D	Tol
D 16	$\begin{matrix} 0 \\ -0.03 \end{matrix}$
D > 16	$\begin{matrix} 0 \\ -0.04 \end{matrix}$

unit (mm)

Workpiece Material				
P		M	S	
1 2 3 4	5	1 2 3	1 2 3	4
Carbon Steel, Alloy steel (< 35HRC)	Alloy steel, Tool steel (< 48HRC)	Stainless Steel	Heat-resistant Alloys	Titanium Alloys
○	○	⊙	○	⊙

● Most Suitable ○ Suitable

Cutting Parameters ※ P457

ST300-RN4

4 FluteCorner Radius, with Reduced Neck variable Helix, Internal Coolant

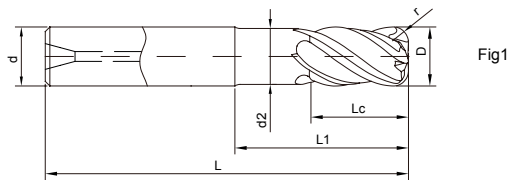

See page 97 for guidelines to icons

Ordering Code	D	r	Lc	L1	d2	L	d	Figure No.	Stock
ST300-RN4-12010	12	1	24	38	11.4	90	12	1	○
ST300-RN4-12030	12	3	24	38	11.4	90	12	1	○
ST300-RN4-16010	16	1	32	47	15.4	100	16	1	○
ST300-RN4-16030	16	3	32	47	15.4	100	16	1	○
ST300-RN4-20010	20	1	40	57	19.4	115	20	1	○
ST300-RN4-20030	20	3	40	57	19.4	115	20	1	○

●Stock ○Available upon Order

D	Tol
D 16	0 -0.03
D > 12	0 -0.04

unit (mm)

Workpiece Material				
P		M	S	
1 2 3 4	5	1 2 3	1 2 3	4
Carbon Steel, Alloy steel (< 35HRC)	Alloy steel , Tool steel (< 48HRC)	Stainless Steel	Heat-resistant Alloys	Titanium Alloys
○	○	⊙	○	⊙

● Most Suitable ○ Suitable

Cutting Parameters ※ P458

ST300-RN5

5 Flute Corner Radius, with Reduced Neck Variable Helix, Internal Coolant

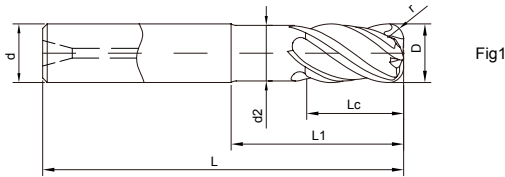
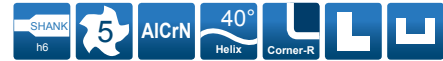

Fig1



See page 97 for guidelines to icons

Ordering Code	D	r	Lc	L1	d2	L	d	Figure No.	Stock
ST300-RN5-16010	16	1	32	47	15.4	100	16	1	○
ST300-RN5-16030	16	3	32	47	15.4	100	16	1	●
ST300-RN5-20010	20	1	40	67	19.4	117	20	1	○
ST300-RN5-20030	20	3	40	67	19.4	117	20	1	○
ST300-RN5-25030	25	3	50	82	24.4	138	25	1	○

● Stock ○ Available upon Order

D	Tol
D 16	0 -0.03
D > 16	0 -0.04

unit (mm)

Workpiece Material				
P		M	S	
1 2 3 4	5	1 2 3	1 2 3	4
Carbon Steel, Alloy steel (< 35HRC)	Alloy steel, Tool steel (< 48HRC)	Stainless Steel	Heat-resistant Alloys	Titanium Alloys
○	○	⊙	○	⊙

● Most Suitable ○ Suitable

Cutting Parameters ※ P459

SH160-R2

2 Flute Corner Radius

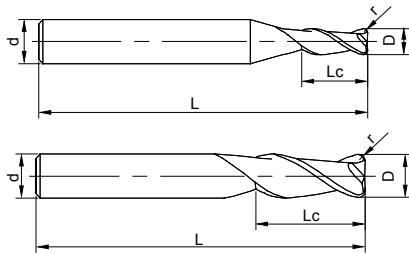

Fig1

Fig2



See page 97 for guidelines to icons

Ordering Code	D	Lc	r	L	d	Figure No.	Stock
SH160-R2-02002	2	6	0.2	50	4	1	●
SH160-R2-03003	3	9	0.3	50	4	1	○
SH160-R2-03005	3	9	0.5	50	4	1	○
SH160-R2-04005	4	10	0.5	50	4	2	○
SH160-R2-04010	4	10	1	50	4	2	●
SH160-R2-05005	5	13	0.5	50	6	1	○
SH160-R2-05010	5	13	1	50	6	1	○
SH160-R2-06005	6	15	0.5	50	6	2	●
SH160-R2-06010	6	15	1	50	6	2	●
SH160-R2-08005	8	20	0.5	60	8	2	○
SH160-R2-08010	8	20	1	60	8	2	●

●Stock ○Available upon Order

D	Tol
D ≤ 12	0 -0.02
D > 12	0 -0.03

unit (mm)

Workpiece Material					
P			H		
1	2	3	4	5	6
Carbon Steel, Alloy steel (< 35HRC)	Alloy steel, Tool steel (<48HRC)	PH, Ferrite, Martensite Steel (< 35HRC)	Hardened Steel (45-55HRC)	Hardened Steel (55-60HRC)	Hardened Steel (> 60HRC)
			⊙		

● Most Suitable ○ Suitable

Cutting Parameters ※ P460

SH160-R2

2 Flute Corner Radius

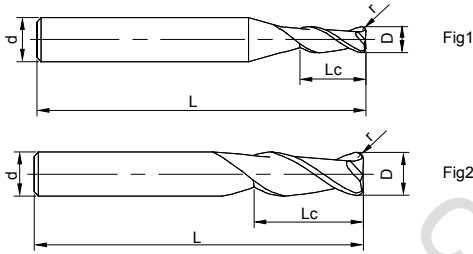

See page 97 for guidelines to icons

» continue

Ordering Code	D	Lc	r	L	d	Figure No.	Stock
SH160-R2-10005	10	25	0.5	75	10	2	○
SH160-R2-10010	10	25	1	75	10	2	○
SH160-R2-10015	10	25	1.5	75	10	2	○
SH160-R2-10020	10	25	2	75	10	2	○
SH160-R2-12005	12	30	0.5	75	12	2	○
SH160-R2-12010	12	30	1	75	12	2	○
SH160-R2-12015	12	30	1.5	75	12	2	○
SH160-R2-12020	12	30	2	75	12	2	○

●Stock ○Available upon Order

D	Tol
D 12	0 -0.02
D > 12	0 -0.03

unit(mm)

Workpiece Material

P			H		
1	2	3	4	5	6
Carbon Steel, Alloy Steel (< 35HRC)	Alloy Steel (35-48HRC)	PH, Ferrite, MartensiteSteel (< 35HRC)	Hardened Steel (45-55HRC)	Hardened Steel (55-60HRC)	Hardened Steel (> 60HRC)
			⊙		

● Most Suitable ○ Suitable

Cutting Parameters ※ P460

SH160-R4

4 Flute Corner Radius

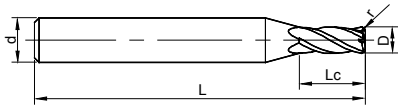

Fig1

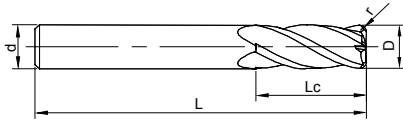

Fig2



See page 97 for guidelines to icons

Ordering Code	D	Lc	r	L	d	Figure No.	Stock
SH160-R4-02002	2	6	0.2	50	4	1	○
SH160-R4-03003	3	9	0.3	50	4	1	●
SH160-R4-03005	3	9	0.5	50	4	1	●
SH160-R4-63003	3	8	0.3	50	6	1	○
SH160-R4-63005	3	8	0.5	50	6	1	●
SH160-R4-04002	4	10	0.2	50	4	2	●
SH160-R4-04003	4	10	0.3	50	4	2	●
SH160-R4-04005	4	10	0.5	50	4	2	●
SH160-R4-04010	4	10	1	50	4	2	●
SH160-R4-64002	4	10	0.2	50	6	1	●
SH160-R4-64003	4	10	0.3	50	6	1	○
SH160-R4-64005	4	10	0.5	50	6	1	●
SH160-R4-64010	4	10	1	50	6	1	○
SH160-R4-05005	5	13	0.5	50	6	1	○
SH160-R4-05010	5	13	1	50	6	1	○

● Stock ○ Available upon Order

D	Tol
D 12	$\begin{matrix} 0 \\ -0.02 \end{matrix}$
D > 12	$\begin{matrix} 0 \\ -0.03 \end{matrix}$

unit(mm)

Workpiece Material					
P			H		
1 2 3 4	5	6	1	2	3 4
Carbon Steel, Alloy Steel (< 35HRC)	Alloy Steel (35-48HRC)	PH, Ferrite, MartensiteSteel (< 35HRC)	Hardened Steel (45-55HRC)	Hardened Steel (55-60HRC)	Hardened Steel (> 60HRC)
			⊙		

● Most Suitable ○ Suitable

Cutting Parameters ※ P460

SH160-R4

4 Flute Corner Radius

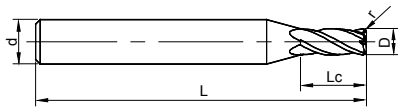

Fig1

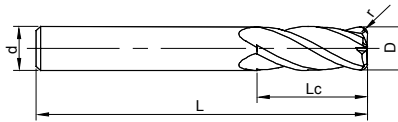

Fig2



See page 97 for guidelines to icons

» continue

Ordering Code	D	Lc	r	L	d	Figure No.	Stock
SH160-R4-06002	6	15	0.2	50	6	2	●
SH160-R4-06003	6	15	0.3	50	6	2	●
SH160-R4-06005	6	15	0.5	50	6	2	●
SH160-R4-06010	6	15	1	50	6	2	●
SH160-R4-08002	8	20	0.2	60	8	2	●
SH160-R4-08003	8	20	0.3	60	8	2	●
SH160-R4-08005	8	20	0.5	60	8	2	●
SH160-R4-08010	8	20	1	60	8	2	●
SH160-R4-10005	10	25	0.5	75	10	2	●
SH160-R4-10010	10	25	1	75	10	2	●
SH160-R4-10015	10	25	1.5	75	10	2	○
SH160-R4-10020	10	25	2	75	10	2	○
SH160-R4-12005	12	30	0.5	75	12	2	●
SH160-R4-12010	12	30	1	75	12	2	●
SH160-R4-12015	12	30	1.5	75	12	2	○
SH160-R4-12020	12	30	2	75	12	2	○

● Stock ○ Available upon Order

D	Tol
D 12	0 -0.02
D > 12	0 -0.03

unit(mm)

Workpiece Material

P			H		
1	2	3	4	5	6
Carbon Steel, Alloy Steel (< 35HRC)	Alloy Steel (35-48HRC)	PH, Ferrite, MartensiteSteel (< 35HRC)	Hardened Steel (45-55HRC)	Hardened Steel (55-60HRC)	Hardened Steel (> 60HRC)
			⊙		

● Most Suitable ○ Suitable

Cutting Parameters ※ P460

SH160-RH4

4 Flute Corner Radius, with Long Shank Length

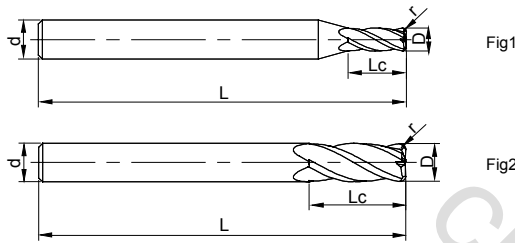

See page 97 for guidelines to icons

Ordering Code	D	Lc	r	L	d	Figure No.	Stock
SH160-RH4-06005	6	15	0.5	75	6	2	●
SH160-RH4-06010	6	15	1	75	6	2	●
SH160-RH4-08005	8	20	0.5	100	8	2	●
SH160-RH4-08010	8	20	1	100	8	2	○
SH160-RH4-10005	10	25	0.5	100	10	2	●
SH160-RH4-10010	10	25	1	100	10	2	●
SH160-RH4-12005	12	30	0.5	100	12	2	●

● Stock ○ Available upon Order

D	Tol
D 12	$\begin{matrix} 0 \\ -0.02 \end{matrix}$
D > 12	$\begin{matrix} 0 \\ -0.03 \end{matrix}$

unit(mm)

Workpiece Material					
P			H		
1	2	3	4	5	6
Carbon Steel, Alloy Steel (< 35HRC)	Alloy Steel (35-48HRC)	PH, Ferrite, MartensiteSteel (< 35HRC)	Hardened Steel (45-55HRC)	Hardened Steel (55-60HRC)	Hardened Steel (> 60HRC)
			⊙		

● Most Suitable ○ Suitable

Cutting Parameters ※ P460

SH200-R4-H

4 Flute Corner Radius

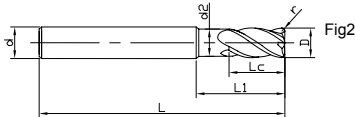
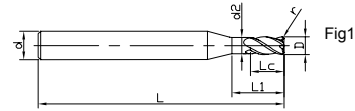

See page 97 for guidelines to icons

Ordering Code	D	Lc	r	d2	L1	L	d	Figure No.	Stock
SH200-R4-01001-H	1	2	0.1	0.96	3	50	4	1	○
SH200-R4-01002-H	1	2	0.2	0.96	3	50	4	1	●
SH200-R4-01501-H	1.5	3	0.15	1.44	4.5	50	4	1	○
SH200-R4-01502-H	1.5	3	0.2	1.44	4.5	50	4	1	●
SH200-R4-01503-H	1.5	3	0.3	1.44	4.5	50	4	1	○
SH200-R4-02001-H	2	4	0.15	1.92	6	50	4	1	○
SH200-R4-02002-H	2	4	0.2	1.92	6	50	4	1	●
SH200-R4-02003-H	2	4	0.3	1.92	6	50	4	1	○
SH200-R4-02005-H	2	4	0.5	1.92	6	50	4	1	○
SH200-R4-03002-H	3	6	0.2	2.88	9	50	4	1	●

●Stock ○Available upon Order

D	Tol
D 6	0 -0.015
6 < D 12	0 -0.02
D > 12	0 -0.03

unit(mm)

Workpiece Material

P			H		
1	2	3	4	5	6
Carbon Steel, Alloy Steel (< 35HRC)	Alloy Steel (35-48HRC)	PH, Ferrite, MartensiteSteel (< 35HRC)	Hardened Steel (45-55HRC)	Hardened Steel (55-60HRC)	Hardened Steel (> 60HRC)
○	◎		◎	○	

◎ Most Suitable ○ Suitable

Cutting Parameters ※ P462

SH200-R4-H

4 Flute Corner Radius

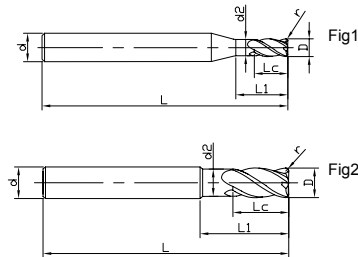

See page 97 for guidelines to icons

» continue

Ordering Code	D	Lc	r	d2	L1	L	d	Figure No.	Stock
SH200-R4-63002-H	3	6	0.2	2.88	9	50	6	1	●
SH200-R4-03003-H	3	6	0.3	2.88	9	50	4	1	●
SH200-R4-03005U-H	3	9	0.5	-	-	50	3	2	●
SH200-R4-03005-H	3	6	0.5	2.88	9	50	4	1	●
SH200-R4-63005-H	3	6	0.5	2.88	9	50	6	1	○
SH200-R4-04002-H	4	8	0.2	3.85	12	50	4	2	●
SH200-R4-64002-H	4	8	0.2	3.85	12	50	6	1	●
SH200-R4-04003-H	4	8	0.3	3.85	12	50	4	2	○
SH200-R4-04005-H	4	8	0.5	3.85	12	50	4	2	●
SH200-R4-64005-H	4	8	0.5	3.85	12	50	6	1	●

● Stock ○ Available upon Order

D	Tol
D 6	0 -0.015
6 < D 12	0 -0.02
D > 12	0 -0.03

unit(mm)

Workpiece Material

P			H		
1	2	3	4	5	6
Carbon Steel, Alloy Steel (< 35HRC)	Alloy Steel (35-48HRC)	PH, Ferrite, MartensiteSteel (< 35HRC)	Hardened Steel (45-55HRC)	Hardened Steel (55-60HRC)	Hardened Steel (> 60HRC)
○	◎		◎	○	

◎ Most Suitable ○ Suitable

Cutting Parameters ※ P462

SH200-R4-H

4 Flute Corner Radius

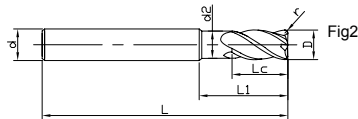
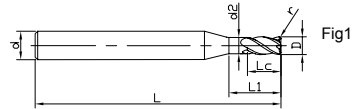

See page 97 for guidelines to icons

» continue

Ordering Code	D	Lc	r	d2	L1	L	d	Figure No.	Stock
SH200-R4-04010-H	4	8	1	3.85	12	50	4	2	●
SH200-R4-05002-H	5	10	0.2	4.8	15	50	6	1	○
SH200-R4-05005-H	5	10	0.5	4.8	15	50	6	1	●
SH200-R4-06002-H	6	12	0.2	5.8	18	50	6	2	●
SH200-R4-06003-H	6	12	0.3	5.8	18	50	6	2	○
SH200-R4-06005-H	6	12	0.5	5.8	18	50	6	2	●
SH200-R4-06010-H	6	12	1	5.8	18	50	6	2	●
SH200-R4-08002-H	8	16	0.2	7.8	24	60	8	2	○
SH200-R4-08005-H	8	16	0.5	7.8	24	60	8	2	●
SH200-R4-08010-H	8	16	1	7.8	24	60	8	2	●

●Stock ○Available upon Order

D	Tol
D 6	0 -0.015
6 < D 12	0 -0.02
D > 12	0 -0.03

unit(mm)

Workpiece Material

P			H		
1 2 3 4	5	6	1	2	3 4
Carbon Steel, Alloy Steel (< 35HRC)	Alloy Steel (35-48HRC)	PH, Ferrite, MartensiteSteel (< 35HRC)	Hardened Steel (45-55HRC)	Hardened Steel (55-60HRC)	Hardened Steel (> 60HRC)
○	◎		◎	○	

◎ Most Suitable ○ Suitable

Cutting Parameters ※ P462

SH200-R4-H

4 Flute Corner Radius

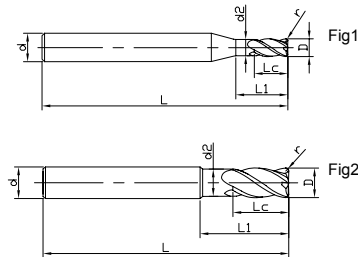

See page 97 for guidelines to icons

» continue

Ordering Code	D	Lc	r	d2	L1	L	d	Figure No.	Stock
SH200-R4-10005-H	10	20	0.5	9.8	30	75	10	2	●
SH200-R4-10010-H	10	20	1	9.8	30	75	10	2	●
SH200-R4-10015-H	10	20	1.5	9.8	30	75	10	2	○
SH200-R4-10020-H	10	20	2	9.8	30	75	10	2	○
SH200-R4-12005-H	12	24	0.5	11.8	36	75	12	2	●
SH200-R4-12005-H	12	24	1	11.8	36	75	12	2	●
SH200-R4-12015-H	12	24	1.5	11.8	36	75	12	2	○
SH200-R4-12020-H	12	24	2	11.8	36	75	12	2	○

● Stock ○ Available upon Order

D	Tol
D 6	0 -0.015
6 < D 12	0 -0.02
D > 12	0 -0.03

unit(mm)

Workpiece Material

P			H		
1	2	3	4	5	6
Carbon Steel, Alloy Steel (< 35HRC)	Alloy Steel (35-48HRC)	PH, Ferrite, MartensiteSteel (< 35HRC)	Hardened Steel (45-55HRC)	Hardened Steel (55-60HRC)	Hardened Steel (> 60HRC)
○	◎		◎	○	

◎ Most Suitable ○ Suitable

Cutting Parameters ※ P462

SH200-RH4-H

4 Flute Corner Radius, with Long Shank Length

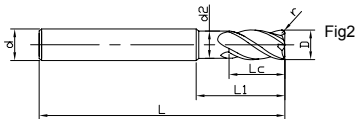
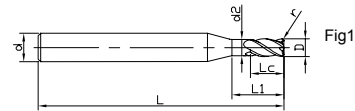

See page 97 for guidelines to icons

Ordering Code	D	Lc	r	d2	L1	L	d	Figure No.	Stock
SH200-RH4-05002-H	5	10	0.2	4.8	15	60	6	1	○
SH200-RH4-05005-H	5	10	0.5	4.8	15	60	6	1	○
SH200-RH4-06002U-H	6	12	0.2	-	-	75	6	2	●
SH200-RH4-06002-H	6	12	0.2	5.8	18	60	6	2	●
SH200-RH4-06005U-H	6	12	0.5	-	-	75	6	2	●
SH200-RH4-06005-H	6	12	0.5	5.8	18	60	6	2	●
SH200-RH4-06010-H	6	12	1	5.8	18	60	6	2	●
SH200-RH4-08002-H	8	16	0.2	7.8	24	75	8	2	○
SH200-RH4-08005U-H	8	16	0.5	-	-	100	8	2	●
SH200-RH4-08005-H	8	16	0.5	7.8	24	75	8	2	●

●Stock ○Available upon Order

D	Tol
D 6	$\begin{matrix} 0 \\ -0.015 \end{matrix}$
6 < D 12	$\begin{matrix} 0 \\ -0.02 \end{matrix}$
D > 12	$\begin{matrix} 0 \\ -0.03 \end{matrix}$

unit(mm)

Workpiece Material

P			H		
1 2 3 4	5	6	1	2	3 4
Carbon Steel, Alloy Steel (< 35HRC)	Alloy Steel (35-48HRC)	PH, Ferrite, MartensiteSteel (< 35HRC)	Hardened Steel (45-55HRC)	Hardened Steel (55-60HRC)	Hardened Steel (> 60HRC)
○	◎		◎	○	

◎ Most Suitable ○ Suitable

Cutting Parameters ※ P462

SH200-RH4-H

4 Flute Corner Radius, with Long Shank Length

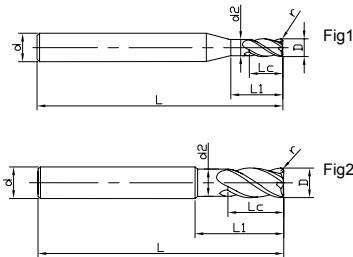

See page 97 for guidelines to icons
» continue

Ordering Code	D	Lc	r	d2	L1	L	d	Figure No.	Stock
SH200-RH4-08010-H	8	16	1	7.8	24	75	8	2	●
SH200-RH4-10005-H	10	20	0.5	9.8	30	100	10	2	●
SH200-RH4-10010-H	10	20	1	9.8	30	100	10	2	●
SH200-RH4-10015-H	10	20	1.5	9.8	30	100	10	2	○
SH200-RH4-10020-H	10	20	2	9.8	30	100	10	2	○
SH200-RH4-12005-H	12	24	0.5	11.8	36	100	12	2	●
SH200-RH4-12010-H	12	24	1	11.8	36	100	12	2	○
SH200-RH4-12015-H	12	24	1.5	11.8	36	100	12	2	○
SH200-RH4-12020-H	12	24	2	11.8	36	100	12	2	○

● Stock ○ Available upon Order

D	Tol
D 6	0 -0.015
6 < D 12	0 -0.02
D > 12	0 -0.03

unit(mm)

Workpiece Material

P			H		
1 2 3 4	5	6	1	2	3 4
Carbon Steel, Alloy Steel (< 35HRC)	Alloy Steel (35-48HRC)	PH, Ferrite, MartensiteSteel (< 35HRC)	Hardened Steel (45-55HRC)	Hardened Steel (55-60HRC)	Hardened Steel (> 60HRC)
○	◎		◎	○	

◎ Most Suitable ○ Suitable

Cutting Parameters ※ P462

SH200-RN4-H

4 Flute Corner Radius, with Reduced Neck

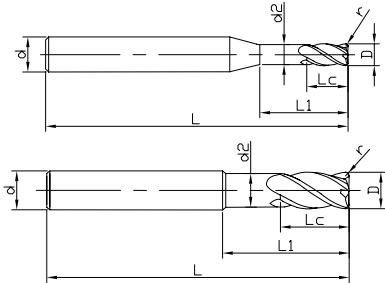

Fig1

Fig2



See page 97 for guidelines to icons

Ordering Code	D	Lc	r	d2	L1	L	d	Figure No.	Stock
SH200-RN4-01501J-H	1.5	3	0.15	1.44	6	50	4	1	●
SH200-RN4-64005J-H	4	8	0.5	5.8	16	60	6	1	○
SH200-RN4-06005J-H	6	12	0.5	5.8	30	75	6	2	●
SH200-RN4-06005-H	6	12	0.5	5.8	30	100	6	2	●
SH200-RN4-06010E-H	6	12	1	5.8	30	75	6	2	○
SH200-RN4-06010-H	6	12	1	5.8	30	100	6	2	○
SH200-RN4-08005-H	8	16	0.5	7.8	40	100	8	2	●
SH200-RN4-08010-H	8	16	1	7.8	40	100	8	2	●
SH200-RN4-10005-H	10	20	0.5	9.8	50	100	10	2	●
SH200-RN4-10010-H	10	20	1	9.8	50	100	10	2	●
SH200-RN4-12005-H	12	24	0.5	11.8	60	120	12	2	○

● Stock ○ Available upon Order

D	Tol
D 6	0 -0.015
6 < D 12	0 -0.02
D > 12	0 -0.03

unit(mm)

Workpiece Material

P			H		
1 2 3 4	5	6	1	2	3 4
Carbon Steel, Alloy Steel (< 35HRC)	Alloy Steel (35-48HRC)	PH, Ferrite, MartensiteSteel (< 35HRC)	Hardened Steel (45-55HRC)	Hardened Steel (55-60HRC)	Hardened Steel (> 60HRC)
○	◎		◎	○	

◎ Most Suitable ○ Suitable

Cutting Parameters ※ P462

SH300-R2-H NEW

2 Flute Corner Radius

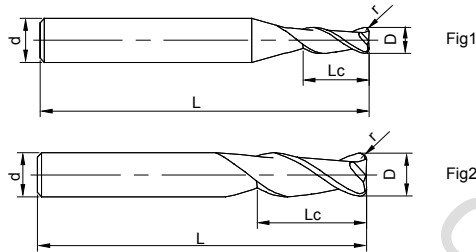

See page 97 for guidelines to icons

Ordering Code	D	Lc	r	L	d	Figure No.	Stock
SH300-R2-01001-H	1	2.5	0.1	50	4	1	○
SH300-R2-01002-H	1	2.5	0.2	50	4	1	○
SH300-R2-02001-H	2	5	0.1	50	4	1	○
SH300-R2-02002-H	2	5	0.2	50	4	1	○
SH300-R2-02003-H	2	5	0.3	50	4	1	○
SH300-R2-63002-H	3	7.5	0.2	50	6	1	○
SH300-R2-63003-H	3	7.5	0.3	50	6	1	○
SH300-R2-63005-H	3	7.5	0.5	50	6	1	○
SH300-R2-04003-H	4	10	0.3	50	4	2	○
SH300-R2-04005-H	4	10	0.5	50	4	2	○
SH300-R2-64005-H	4	10	0.5	50	6	1	○
SH300-R2-04010-H	4	10	1	50	4	2	○
SH300-R2-64010-H	4	10	1	50	6	1	○
SH300-R2-05005-H	5	12.5	0.5	50	6	1	○

●Stock ○Available upon Order

D	Tol
D 8	0 -0.01
10 D 12	0 -0.015

unit(mm)

Workpiece Material					
P			H		
1	2	3	4	5	6
Carbon Steel, Alloy Steel (< 35HRC)	Alloy Steel (35-48HRC)	PH, Ferrite, MartensiteSteel (< 35HRC)	Hardened Steel (45-55HRC)	Hardened Steel (55-60HRC)	Hardened Steel (> 60HRC)
	○		○	◎	◎

◎ Most Suitable ○ Suitable

Cutting Parameters ※ P463

SH300-R2-H NEW

2 Flute Corner Radius

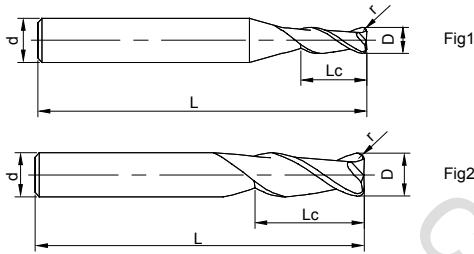

See page 97 for guidelines to icons

» continue

Ordering Code	D	Lc	r	L	d	Figure No.	Stock
SH300-R2-05010-H	5	12.5	1	50	6	1	○
SH300-R2-06005-H	6	15	0.5	50	6	2	○
SH300-R2-06010-H	6	15	1	50	6	2	○
SH300-R2-08005-H	8	20	0.5	60	8	2	○
SH300-R2-08010-H	8	20	1	60	8	2	○
SH300-R2-10005-H	10	25	0.5	75	10	2	○
SH300-R2-10010-H	10	25	1	75	10	2	○
SH300-R2-10015-H	10	25	1.5	75	10	2	○
SH300-R2-10020-H	10	25	2	75	10	2	○
SH300-R2-12005-H	12	30	0.5	75	12	2	○
SH300-R2-12010-H	12	30	1	75	12	2	○
SH300-R2-12015-H	12	30	1.5	75	12	2	○
SH300-R2-12020-H	12	30	2	75	12	2	○

●Stock ○Available upon Order

D	Tol
D 8	0 -0.01
10 D 12	0 -0.015

unit(mm)

Workpiece Material

P			H		
1 2 3 4	5	6	1	2	3 4
Carbon Steel, Alloy Steel (< 35HRC)	Alloy Steel (35-48HRC)	PH, Ferrite, MartensiteSteel (< 35HRC)	Hardened Steel (45-55HRC)	Hardened Steel (55-60HRC)	Hardened Steel (> 60HRC)
	○		○	◎	◎

◎ Most Suitable ○ Suitable

Cutting Parameters ※ P463

SH300-RN2-H NEW

2 Flute Corner Radius, with Reduced Neck

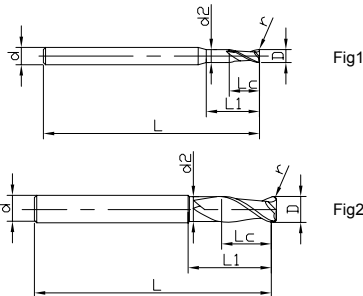

See page 97 for guidelines to icons

Ordering Code	D	Lc	r	L1	d2	L	d	Figure No.	Stock
SH300-RN2-01001-H	1	1.5	0.1	6	0.95	50	4	1	○
SH300-RN2-01002-H	1	1.5	0.2	6	0.95	50	4	1	○
SH300-RN2-02001-H	2	3	0.1	12	1.95	50	4	1	○
SH300-RN2-02002-H	2	3	0.2	12	1.95	50	4	1	○
SH300-RN2-02003-H	2	3	0.3	12	1.95	50	4	1	○
SH300-RN2-63002-H	3	4.5	0.2	18	2.9	60	6	1	○
SH300-RN2-63003-H	3	4.5	0.3	18	2.9	60	6	1	○
SH300-RN2-63005-H	3	4.5	0.5	18	2.9	60	6	1	○
SH300-RN2-64005-H	4	6	0.5	24	3.9	75	6	1	○
SH300-RN2-64010-H	4	6	1	24	3.9	75	6	1	○
SH300-RN2-05005-H	5	7.5	0.5	30	4.9	75	6	1	○
SH300-RN2-05010-H	5	7.5	1	30	4.9	75	6	1	○
SH300-RN2-06005-H	6	9	0.5	36	5.9	90	6	2	○
SH300-RN2-06010-H	6	9	1	36	5.9	90	6	2	○

● Stock ○ Available upon Order

D	Tol
D 8	$\begin{matrix} 0 \\ -0.01 \end{matrix}$
10 D 12	$\begin{matrix} 0 \\ -0.015 \end{matrix}$

unit(mm)

Workpiece Material					
P			H		
1	2	3	4	5	6
Carbon Steel, Alloy Steel (< 35HRC)	Alloy Steel (35-48HRC)	PH, Ferrite, MartensiteSteel (< 35HRC)	Hardened Steel (45-55HRC)	Hardened Steel (55-60HRC)	Hardened Steel (> 60HRC)
	○		○	◎	◎

● Most Suitable ○ Suitable

Cutting Parameters ※ P463

SH300-R4-H NEW

4 Flute Corner Radius

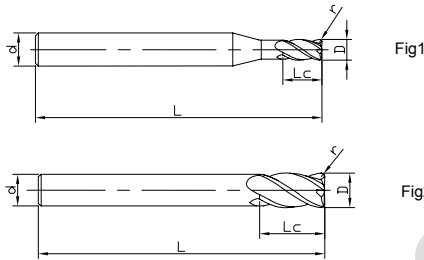

See page 97 for guidelines to icons

Ordering Code	D	Lc	r	L	d	Figure No.	Stock
SH300-RH4-31001-H	1	3.5	0.1	60	3	1	○
SH300-RH4-01001-H	1	3.5	0.1	60	4	1	○
SH300-RH4-61001-H	1	3.5	0.1	60	6	1	○
SH300-RH4-31002-H	1	3.5	0.2	60	3	1	○
SH300-RH4-01002-H	1	3.5	0.2	60	4	1	○
SH300-RH4-61002-H	1	3.5	0.2	60	6	1	○
SH300-RH4-31501-H	1.5	5	0.1	60	3	1	○
SH300-RH4-01501-H	1.5	5	0.1	60	4	1	○
SH300-RH4-61501-H	1.5	5	0.1	60	6	1	○
SH300-RH4-31502-H	1.5	5	0.2	60	3	1	○
SH300-RH4-01502-H	1.5	5	0.2	60	4	1	○
SH300-RH4-61502-H	1.5	5	0.2	60	6	1	○

●Stock ○Available upon Order

D	Tol
D 8	0 -0.01
10 D 12	0 -0.015
D > 12	0 -0.02

unit(mm)

Workpiece Material					
P			H		
1	2	3	4	5	6
Carbon Steel, Alloy Steel (< 35HRC)	Alloy Steel (35-48HRC)	PH, Ferrite, MartensiteSteel (< 35HRC)	Hardened Steel (45-55HRC)	Hardened Steel (55-60HRC)	Hardened Steel (> 60HRC)
	○		○	⊙	⊙

⊙ Most Suitable ○ Suitable

Cutting Parameters ※ P463

SH300-R4-H NEW

4 Flute Corner Radius

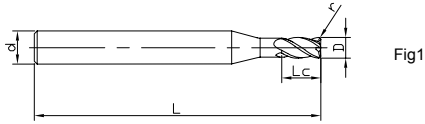

Fig1

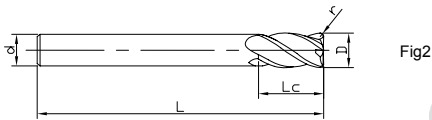

Fig2



See page 97 for guidelines to icons

» continue

Ordering Code	D	Lc	r	L	d	Figure No.	Stock
SH300-R4-32001-H	2	7	0.1	50	3	1	○
SH300-R4-02001-H	2	7	0.1	50	4	1	○
SH300-R4-62001-H	2	7	0.1	50	6	1	○
SH300-R4-32002-H	2	7	0.2	50	3	1	○
SH300-R4-02002-H	2	7	0.2	50	4	1	●
SH300-R4-62002-H	2	7	0.2	50	6	1	○
SH300-R4-33002-H	3	10	0.2	50	3	2	○
SH300-R4-03002-H	3	10	0.2	50	4	1	○
SH300-R4-63002-H	3	10	0.2	50	6	1	○
SH300-R4-33005-H	3	10	0.5	50	3	2	○
SH300-R4-03005-H	3	10	0.5	50	4	1	●
SH300-R4-63005-H	3	10	0.5	50	6	1	○

●Stock ○Available upon Order

D	Tol
D 8	0 -0.01
10 D 12	0 -0.015
D > 12	0 -0.02

unit(mm)

Workpiece Material					
P			H		
1	2	3	4	5	6
Carbon Steel, Alloy Steel (< 35HRC)	Alloy Steel (35-48HRC)	PH, Ferrite, MartensiteSteel (< 35HRC)	Hardened Steel (45-55HRC)	Hardened Steel (55-60HRC)	Hardened Steel (> 60HRC)
	○		○	◎	◎

◎ Most Suitable ○ Suitable

Cutting Parameters ※ P463

SH300-R4-H NEW

4 Flute Corner Radius

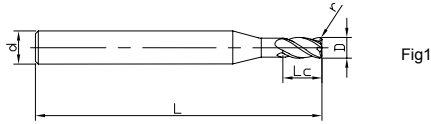

Fig1

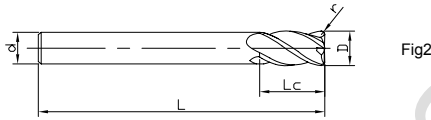

Fig2



See page 97 for guidelines to icons

» continue

Ordering Code	D	Lc	r	L	d	Figure No.	Stock
SH300-R4-04002-H	4	12	0.2	50	4	2	○
SH300-R4-64002-H	4	12	0.2	50	6	1	○
SH300-R4-04005-H	4	12	0.5	50	4	2	○
SH300-R4-64005-H	4	12	0.5	50	6	1	○
SH300-R4-05002-H	5	15	0.2	50	6	1	○
SH300-R4-05005-H	5	15	0.5	50	6	1	○
SH300-R4-06005-H	6	15	0.5	50	6	2	●
SH300-R4-06010-H	6	15	1	50	6	2	●
SH300-R4-08005-H	8	20	0.5	60	8	2	●
SH300-R4-08005E-H	8	20	0.5	75	8	2	○
SH300-R4-08010-H	8	20	1	60	8	2	○
SH300-R4-08010E-H	8	20	1	75	8	2	○

● Stock ○ Available upon Order

D	Tol
D 8	0 -0.01
10 D 12	0 -0.015
D > 12	0 -0.02

unit(mm)

Workpiece Material					
P			H		
1	2	3	4	5	6
Carbon Steel, Alloy Steel (< 35HRC)	Alloy Steel (35-48HRC)	PH, Ferrite, MartensiteSteel (< 35HRC)	Hardened Steel (45-55HRC)	Hardened Steel (55-60HRC)	Hardened Steel (> 60HRC)
	○		○	◎	◎

◎ Most Suitable ○ Suitable

Cutting Parameters ※ P463

SH300-R4-H NEW

4 Flute Corner Radius

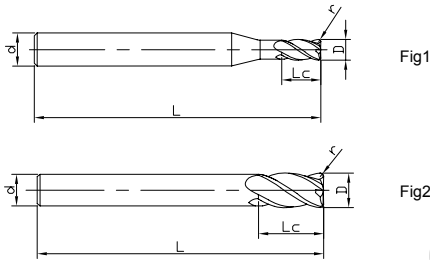

See page 97 for guidelines to icons

» continue

Ordering Code	D	Lc	r	L	d	Figure No.	Stock
SH300-R4-10005-H	10	25	0.5	75	10	2	○
SH300-R4-10010-H	10	25	1	75	10	2	○
SH300-R4-10020-H	10	25	2	75	10	2	○
SH300-R4-12005-H	12	30	0.5	75	12	2	○
SH300-R4-12010-H	12	30	1	75	12	2	●
SH300-R4-12020-H	12	30	2	75	12	2	○
SH300-R4-16010-H	16	40	1	100	16	2	○
SH300-R4-16020-H	16	40	2	100	16	2	○
SH300-R4-20010-H	20	45	1	100	20	2	○
SH300-R4-20020-H	20	45	2	100	20	2	○
SH300-R4-20030-H	20	45	3	100	20	2	○

● Stock ○ Available upon Order

D	Tol
D 8	$\begin{matrix} 0 \\ -0.01 \end{matrix}$
10 D 12	$\begin{matrix} 0 \\ -0.015 \end{matrix}$
D > 12	$\begin{matrix} 0 \\ -0.02 \end{matrix}$

unit(mm)

Workpiece Material					
P			H		
1	2	3	4	5	6
Carbon Steel, Alloy Steel (< 35HRC)	Alloy Steel (35-48HRC)	PH, Ferrite, Martensite Steel (< 35HRC)	Hardened Steel (45-55HRC)	Hardened Steel (55-60HRC)	Hardened Steel (> 60HRC)
	○		○	◎	◎

◎ Most Suitable ○ Suitable

Cutting Parameters ※ P463

SH300-RH4-H NEW

4 Flute Corner Radius, with Long Shank Length

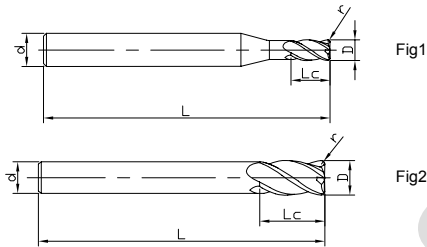

See page 97 for guidelines to icons

Ordering Code	D	Lc	r	L	d	Figure No.	Stock
SH300-RH4-31001-H	1	3.5	0.1	60	3	1	○
SH300-RH4-01001-H	1	3.5	0.1	60	4	1	○
SH300-RH4-61001-H	1	3.5	0.1	60	6	1	○
SH300-RH4-31002-H	1	3.5	0.2	60	3	1	○
SH300-RH4-01002-H	1	3.5	0.2	60	4	1	○
SH300-RH4-61002-H	1	3.5	0.2	60	6	1	○
SH300-RH4-31501-H	1.5	5	0.1	60	3	1	○
SH300-RH4-01501-H	1.5	5	0.1	60	4	1	○
SH300-RH4-61501-H	1.5	5	0.1	60	6	1	○
SH300-RH4-31502-H	1.5	5	0.2	60	3	1	○
SH300-RH4-01502-H	1.5	5	0.2	60	4	1	○
SH300-RH4-61502-H	1.5	5	0.2	60	6	1	○

●Stock ○Available upon Order

D	Tol
D 8	0 -0.01
10 D 12	0 -0.015
D > 12	0 -0.02

unit(mm)

Workpiece Material					
P			H		
1	2	3	4	5	6
Carbon Steel, Alloy Steel (< 35HRC)	Alloy Steel (35-48HRC)	PH, Ferrite, MartensiteSteel (< 35HRC)	Hardened Steel (45-55HRC)	Hardened Steel (55-60HRC)	Hardened Steel (> 60HRC)
	○		○	◎	◎

◎ Most Suitable ○ Suitable

Cutting Parameters ※ P463

SH300-RH4-H NEW

4 Flute Corner Radius, with Long Shank Length

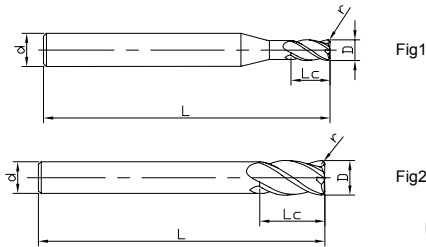

See page 97 for guidelines to icons

» continue

Ordering Code	D	Lc	r	L	d	Figure No.	Stock
SH300-RH4-32001-H	2	7	0.1	60	3	1	○
SH300-RH4-02001J-H	2	6	0.1	60	4	1	○
SH300-RH4-02001-H	2	7	0.1	60	4	1	○
SH300-RH4-62001-H	2	7	0.1	60	6	1	○
SH300-RH4-32002-H	2	7	0.2	60	3	1	○
SH300-RH4-02002-H	2	7	0.2	60	4	1	○
SH300-RH4-62002-H	2	7	0.2	60	6	1	○
SH300-RH4-33002-H	3	10	0.2	60	3	2	○
SH300-RH4-03002-H	3	10	0.2	60	4	1	○
SH300-RH4-63002A-H	3	8	0.2	60	6	1	○
SH300-RH4-63002-H	3	10	0.2	60	6	1	○
SH300-RH4-33005-H	3	10	0.5	60	3	2	○

●Stock ○Available upon Order

D	Tol
D 8	0 -0.01
10 D 12	0 -0.015
D > 12	0 -0.02

unit(mm)

Workpiece Material					
P			H		
1	2	3	4	5	6
Carbon Steel, Alloy Steel (< 35HRC)	Alloy Steel (35-48HRC)	PH, Ferrite, MartensiteSteel (< 35HRC)	Hardened Steel (45-55HRC)	Hardened Steel (55-60HRC)	Hardened Steel (> 60HRC)
	○		○	◎	◎

◎ Most Suitable ○ Suitable

Cutting Parameters ※ P463

SH300-RH4-H NEW

4 Flute Corner Radius, with Long Shank Length

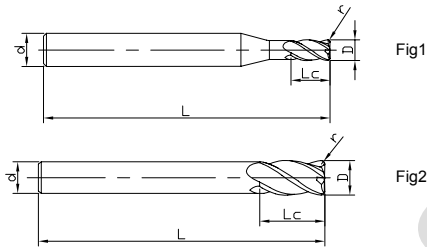

See page 97 for guidelines to icons

» continue

Ordering Code	D	Lc	r	L	d	Figure No.	Stock
SH300-RH4-03005-H	3	10	0.5	60	4	1	○
SH300-RH4-63005-H	3	10	0.5	60	6	1	○
SH300-RH4-04002-H	4	12	0.2	60	4	2	●
SH300-RH4-04005-H	4	12	0.5	60	4	2	○
SH300-RH4-05002-H	5	15	0.2	60	6	1	○
SH300-RH4-05005-H	5	15	0.5	60	6	1	○
SH300-RH4-06005-H	6	15	0.5	60	6	2	○
SH300-RH4-06005E-H	6	15	0.5	75	6	2	●
SH300-RH4-06010-H	6	15	1	60	6	2	○
SH300-RH4-06010E-H	6	15	1	75	6	2	○
SH300-RH4-08005-H	8	20	0.5	100	8	2	●
SH300-RH4-08010-H	8	20	1	100	8	2	○

●Stock ○Available upon Order

D	Tol
D 8	$\begin{matrix} 0 \\ -0.01 \end{matrix}$
10 D 12	$\begin{matrix} 0 \\ -0.015 \end{matrix}$
D > 12	$\begin{matrix} 0 \\ -0.02 \end{matrix}$

unit(mm)

Workpiece Material					
P			H		
1	2	3	4	5	6
Carbon Steel, Alloy Steel (< 35HRC)	Alloy Steel (35-48HRC)	PH, Ferrite, MartensiteSteel (< 35HRC)	Hardened Steel (45-55HRC)	Hardened Steel (55-60HRC)	Hardened Steel (> 60HRC)
	○		○	◎	◎

◎ Most Suitable ○ Suitable

Cutting Parameters ※ P463

SH300-RH4-H NEW

4 Flute Corner Radius, with Long Shank Length

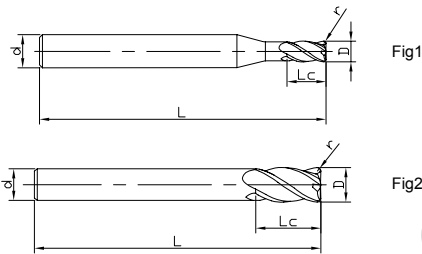

See page 97 for guidelines to icons

» continue

Ordering Code	D	Lc	r	L	d	Figure No.	Stock
SH300-RH4-10005-H	10	25	0.5	100	10	2	○
SH300-RH4-10010-H	10	25	1	100	10	2	●
SH300-RH4-10020-H	10	25	2	100	10	2	●
SH300-RH4-12005-H	12	30	0.5	100	12	2	●
SH300-RH4-12010-H	12	30	1	100	12	2	●
SH300-RH4-12020-H	12	30	2	100	12	2	●
SH300-RH4-16010-H	16	40	1	150	16	2	○
SH300-RH4-16020-H	16	40	2	150	16	2	○
SH300-RH4-20010-H	20	45	1	150	20	2	○
SH300-RH4-20020-H	20	45	2	150	20	2	○
SH300-RH4-20030-H	20	45	2	150	20	2	○

● Stock ○ Available upon Order

D	Tol
D 8	$\begin{matrix} 0 \\ -0.01 \end{matrix}$
10 D 12	$\begin{matrix} 0 \\ -0.015 \end{matrix}$
D > 12	$\begin{matrix} 0 \\ -0.02 \end{matrix}$

unit(mm)

Workpiece Material					
P			H		
1 2 3 4	5	6	1	2	3 4
Carbon Steel, Alloy Steel (< 35HRC)	Alloy Steel (35-48HRC)	PH, Ferrite, Martensite Steel (< 35HRC)	Hardened Steel (45-55HRC)	Hardened Steel (55-60HRC)	Hardened Steel (> 60HRC)
	○		○	◎	◎

◎ Most Suitable ○ Suitable

Cutting Parameters ※ P463

SH300-RN4-H NEW

4 Flute Corner Radius, with Reduced Neck

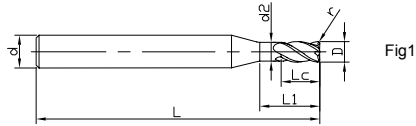

Fig1

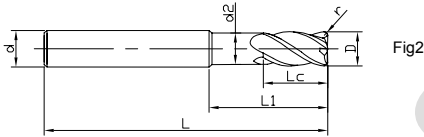

Fig2



See page 97 for guidelines to icons

Ordering Code	D	Lc	r	L1	d2	L	d	Figure No.	Stock
SH300-RN4-31001-H	1	2	0.1	4	0.95	50	3	1	○
SH300-RN4-01001-H	1	2	0.1	4	0.95	50	4	1	○
SH300-RN4-61001-H	1	2	0.1	4	0.95	50	6	1	○
SH300-RN4-31001E-H	1	2	0.1	4	0.95	60	3	1	○
SH300-RN4-01001E-H	1	2	0.1	4	0.95	60	4	1	●
SH300-RN4-61001E-H	1	2	0.1	4	0.95	60	6	1	○
SH300-RN4-01001M-H	1	2	0.1	6	0.95	50	4	1	○
SH300-RN4-31002-H	1	2	0.2	4	0.95	50	3	1	○
SH300-RN4-01002-H	1	2	0.2	4	0.95	50	4	1	○
SH300-RN4-61002-H	1	2	0.2	4	0.95	50	6	1	○
SH300-RN4-31002E-H	1	2	0.2	4	0.95	60	3	1	○

●Stock ○Available upon Order

D	Tol
D 8	0 -0.01
10 D 12	0 -0.015
D > 12	0 -0.02

unit(mm)

Workpiece Material

P			H		
1	2	3	4	5	6
Carbon Steel, Alloy Steel (< 35HRC)	Alloy Steel (35-48HRC)	PH, Ferrite, MartensiteSteel (< 35HRC)	Hardened Steel (45-55HRC)	Hardened Steel (55-60HRC)	Hardened Steel (> 60HRC)
	○		○	◎	◎

◎ Most Suitable ○ Suitable

Cutting Parameters ※ P463

SH300-RN4-H NEW

4 Flute Corner Radius, with Reduced Neck

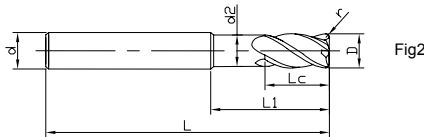
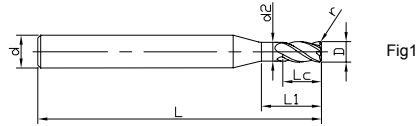

See page 97 for guidelines to icons

» continue

Ordering Code	D	Lc	r	L1	d2	L	d	Figure No.	Stock
SH300-RN4-01002E-H	1	2	0.2	4	0.95	60	4	1	○
SH300-RN4-61002E-H	1	2	0.2	4	0.95	60	6	1	○
SH300-RN4-31501-H	1.5	3	0.1	6	1.45	50	3	1	○
SH300-RN4-01501-H	1.5	3	0.1	6	1.45	50	4	1	○
SH300-RN4-61501-H	1.5	3	0.1	6	1.45	50	6	1	○
SH300-RN4-31501E-H	1.5	3	0.1	6	1.45	60	3	1	○
SH300-RN4-01501E-H	1.5	3	0.1	6	1.45	60	4	1	○
SH300-RN4-61501E-H	1.5	3	0.1	6	1.45	60	6	1	○
SH300-RN4-31502-H	1.5	3	0.2	6	1.45	50	3	1	○
SH300-RN4-01502-H	1.5	3	0.2	6	1.45	50	4	1	○
SH300-RN4-61502-H	1.5	3	0.2	6	1.45	50	6	1	○

●Stock ○Available upon Order

D	Tol
D 8	0 -0.01
10 D 12	0 -0.015
D > 12	0 -0.02

unit(mm)

Workpiece Material

P			H		
1	2	3	4	5	6
Carbon Steel, Alloy Steel (< 35HRC)	Alloy Steel (35-48HRC)	PH, Ferrite, MartensiteSteel (< 35HRC)	Hardened Steel (45-55HRC)	Hardened Steel (55-60HRC)	Hardened Steel (> 60HRC)
	○		○	◎	◎

◎ Most Suitable ○ Suitable

Cutting Parameters ※ P463

SH300-RN4-H NEW

4 Flute Corner Radius, with Reduced Neck

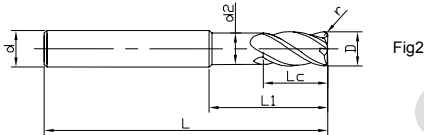
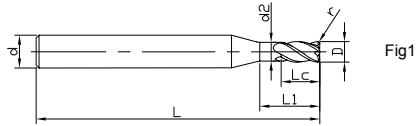

See page 97 for guidelines to icons

» continue

Ordering Code	D	Lc	r	L1	d2	L	d	Figure No.	Stock
SH300-RN4-31502E-H	1.5	3	0.2	6	1.45	60	3	1	○
SH300-RN4-01502E-H	1.5	3	0.2	6	1.45	60	4	1	○
SH300-RN4-61502E-H	1.5	3	0.2	6	1.45	60	6	1	○
SH300-RN4-32001-H	2	4	0.1	8	1.95	50	3	1	○
SH300-RN4-02001-H	2	4	0.1	8	1.95	50	4	1	○
SH300-RN4-62001-H	2	4	0.1	8	1.95	50	6	1	○
SH300-RN4-32001E-H	2	4	0.1	8	1.95	60	3	1	○
SH300-RN4-02001J-H	2	4	0.1	6	1.95	60	4	1	●
SH300-RN4-02001E-H	2	4	0.1	8	1.95	60	4	1	●
SH300-RN4-62001E-H	2	4	0.1	8	1.95	60	6	1	○
SH300-RN4-32002-H	2	4	0.2	8	1.95	50	3	1	○

●Stock ○Available upon Order

D	Tol
D 8	0 -0.01
10 D 12	0 -0.015
D > 12	0 -0.02

unit(mm)

Workpiece Material

P			H		
1	2	3	4	5	6
Carbon Steel, Alloy Steel (< 35HRC)	Alloy Steel (35-48HRC)	PH, Ferrite, MartensiteSteel (< 35HRC)	Hardened Steel (45-55HRC)	Hardened Steel (55-60HRC)	Hardened Steel (> 60HRC)
	○		○	◎	◎

◎ Most Suitable ○ Suitable

Cutting Parameters ※ P463

SH300-RN4-H NEW

4 Flute Corner Radius, with Reduced Neck

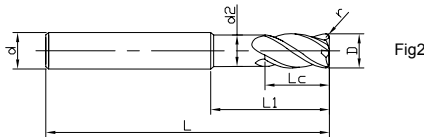
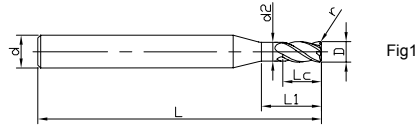

See page 97 for guidelines to icons

» continue

Ordering Code	D	Lc	r	L1	d2	L	d	Figure No.	Stock
SH300-RN4-02002-H	2	4	0.2	8	1.95	50	4	1	○
SH300-RN4-62002-H	2	4	0.2	8	1.95	50	6	1	○
SH300-RN4-32002E-H	2	4	0.2	8	1.95	60	3	1	○
SH300-RN4-02002E-H	2	4	0.2	8	1.95	60	4	1	○
SH300-RN4-62002E-H	2	4	0.2	8	1.95	60	6	1	○
SH300-RN4-33002-H	3	6	0.2	12	2.9	50	3	2	○
SH300-RN4-03002-H	3	6	0.2	12	2.9	50	4	1	○
SH300-RN4-63002-H	3	6	0.2	12	2.9	50	6	1	○
SH300-RN4-33002E-H	3	6	0.2	12	2.9	60	3	2	○
SH300-RN4-03002E-H	3	6	0.2	12	2.9	60	4	1	●
SH300-RN4-63002J-H	3	6	0.2	12	2.9	60	6	1	●

●Stock ○Available upon Order

D	Tol
D 8	0 -0.01
10 D 12	0 -0.015
D > 12	0 -0.02

unit(mm)

Workpiece Material

P			H		
1	2	3	4	5	6
Carbon Steel, Alloy Steel (< 35HRC)	Alloy Steel (35-48HRC)	PH, Ferrite, MartensiteSteel (< 35HRC)	Hardened Steel (45-55HRC)	Hardened Steel (55-60HRC)	Hardened Steel (> 60HRC)
	○		○	◎	◎

◎ Most Suitable ○ Suitable

Cutting Parameters ※ P463

SH300-RN4-H NEW

4 Flute Corner Radius, with Reduced Neck

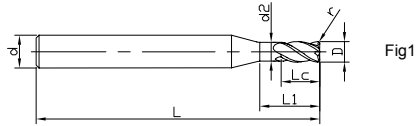

Fig1

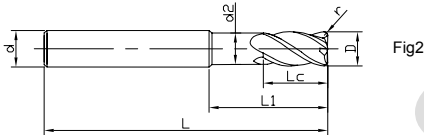

Fig2



See page 97 for guidelines to icons

» continue

Ordering Code	D	Lc	r	L1	d2	L	d	Figure No.	Stock
SH300-RN4-63002E-H	3	6	0.2	12	2.9	60	6	1	○
SH300-RN4-33005-H	3	6	0.5	12	2.9	50	3	2	○
SH300-RN4-03005-H	3	6	0.5	12	2.9	50	4	1	○
SH300-RN4-63005-H	3	6	0.5	12	2.9	50	6	1	○
SH300-RN4-33005E-H	3	6	0.5	12	2.9	60	3	2	○
SH300-RN4-03005E-H	3	6	0.5	12	2.9	60	4	1	○
SH300-RN4-63005E-H	3	6	0.5	12	2.9	60	6	1	○
SH300-RN4-04002-H	4	8	0.2	16	3.9	50	4	2	○
SH300-RN4-64002-H	4	8	0.2	16	3.9	50	6	1	○
SH300-RN4-04002E-H	4	8	0.2	16	3.9	60	4	2	○
SH300-RN4-64002E-H	4	8	0.2	16	3.9	60	6	1	○

●Stock ○Available upon Order

D	Tol
D 8	0 -0.01
10 D 12	0 -0.015
D > 12	0 -0.02

unit(mm)

Workpiece Material

P			H		
1	2	3	4	5	6
Carbon Steel, Alloy Steel (< 35HRC)	Alloy Steel (35-48HRC)	PH, Ferrite, MartensiteSteel (< 35HRC)	Hardened Steel (45-55HRC)	Hardened Steel (55-60HRC)	Hardened Steel (> 60HRC)
	○		○	◎	◎

◎ Most Suitable ○ Suitable

Cutting Parameters ※ P463

SH300-RN4-H NEW

4 Flute Corner Radius, with Reduced Neck

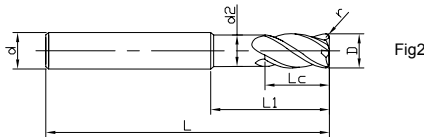
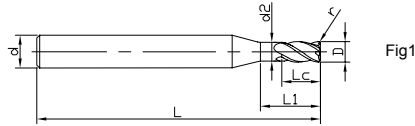

See page 97 for guidelines to icons

» continue

Ordering Code	D	Lc	r	L1	d2	L	d	Figure No.	Stock
SH300-RN4-04005-H	4	8	0.5	16	3.9	50	4	2	○
SH300-RN4-64005-H	4	8	0.5	16	3.9	50	6	1	●
SH300-RN4-04005E-H	4	8	0.5	16	3.9	60	4	2	○
SH300-RN4-64005E-H	4	8	0.5	16	3.9	60	6	1	○
SH300-RN4-64005L-H	4	8	0.5	20	3.9	60	6	1	●
SH300-RN4-05002-H	5	10	0.2	20	4.9	50	6	1	○
SH300-RN4-05002F-H	5	10	0.2	20	4.9	75	6	1	○
SH300-RN4-05005-H	5	10	0.5	20	4.9	50	6	1	○
SH300-RN4-05005F-H	5	10	0.5	20	4.9	75	6	1	○
SH300-RN4-06005J-H	6	12	0.5	24	5.9	60	6	2	○
SH300-RN4-06005-H	6	12	0.5	24	5.9	50	6	2	○

● Stock ○ Available upon Order

D	Tol
D 8	0 -0.01
10 D 12	0 -0.015
D > 12	0 -0.02

unit(mm)

Workpiece Material

P			H		
1	2	3	4	5	6
Carbon Steel, Alloy Steel (< 35HRC)	Alloy Steel (35-48HRC)	PH, Ferrite, MartensiteSteel (< 35HRC)	Hardened Steel (45-55HRC)	Hardened Steel (55-60HRC)	Hardened Steel (> 60HRC)
	○		○	◎	◎

◎ Most Suitable ○ Suitable

Cutting Parameters ※ P463

SH300-RN4-H NEW

4 Flute Corner Radius, with Reduced Neck

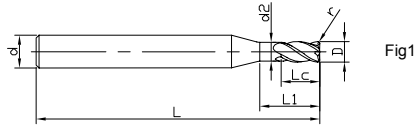

Fig1

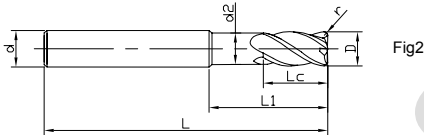

Fig2



See page 97 for guidelines to icons

» continue

Ordering Code	D	Lc	r	L1	d2	L	d	Figure No.	Stock
SH300-RN4-06005E-H	6	12	0.5	24	5.9	60	6	2	○
SH300-RN4-06005F-H	6	12	0.5	24	5.9	75	6	2	●
SH300-RN4-06010-H	6	12	1	24	5.9	50	6	2	○
SH300-RN4-06010E-H	6	12	1	24	5.9	60	6	2	○
SH300-RN4-06010F-H	6	12	1	24	5.9	75	6	2	○
SH300-RN4-08005-H	8	16	0.5	32	7.9	60	8	2	○
SH300-RN4-08005E-H	8	16	0.5	32	7.9	75	8	2	○
SH300-RN4-08010-H	8	16	1	32	7.9	60	8	2	○
SH300-RN4-08010E-H	8	16	1	32	7.9	75	8	2	●
SH300-RN4-10005-H	10	20	0.5	40	9.9	75	10	2	○
SH300-RN4-10005F-H	10	20	0.5	40	9.9	100	10	2	○

●Stock ○Available upon Order

D	Tol
D 8	0 -0.01
10 D 12	0 -0.015
D > 12	0 -0.02

unit(mm)

Workpiece Material

P			H		
1	2	3	4	5	6
Carbon Steel, Alloy Steel (< 35HRC)	Alloy Steel (35-48HRC)	PH, Ferrite, MartensiteSteel (< 35HRC)	Hardened Steel (45-55HRC)	Hardened Steel (55-60HRC)	Hardened Steel (> 60HRC)
	○		○	◎	◎

◎ Most Suitable ○ Suitable

Cutting Parameters ※ P463

SH300-RN4-H NEW

4 Flute Corner Radius, with Reduced Neck

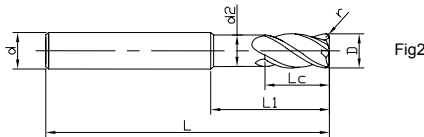
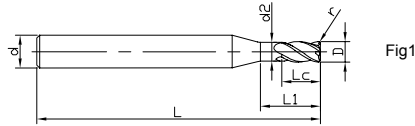

See page 97 for guidelines to icons

» continue

Ordering Code	D	Lc	r	L1	d2	L	d	Figure No.	Stock
SH300-RN4-10010-H	10	20	1	40	9.9	75	10	2	○
SH300-RN4-10010F-H	10	20	1	40	9.9	100	10	2	○
SH300-RN4-10020-H	10	20	2	40	9.9	75	10	2	○
SH300-RN4-10020F-H	10	20	2	40	9.9	100	10	2	○
SH300-RN4-12005-H	12	24	0.5	48	11.9	75	12	2	○
SH300-RN4-12005F-H	12	24	0.5	48	11.9	100	12	2	○
SH300-RN4-12010-H	12	24	1	48	11.9	75	12	2	○
SH300-RN4-12010F-H	12	24	1	48	11.9	100	12	2	●
SH300-RN4-12020-H	12	24	2	48	11.9	75	12	2	○
SH300-RN4-12020F-H	12	24	2	48	11.9	100	12	2	○

● Stock ○ Available upon Order

D	Tol
D 8	0 -0.01
10 D 12	0 -0.015
D > 12	0 -0.02

unit(mm)

Workpiece Material

P			H		
1	2	3	4	5	6
Carbon Steel, Alloy Steel (< 35HRC)	Alloy Steel (35-48HRC)	PH, Ferrite, MartensiteSteel (< 35HRC)	Hardened Steel (45-55HRC)	Hardened Steel (55-60HRC)	Hardened Steel (> 60HRC)
	○		○	◎	◎

◎ Most Suitable ○ Suitable

Cutting Parameters ※ P463

SH300-R6-H NEW

6 Flute Corner Radius

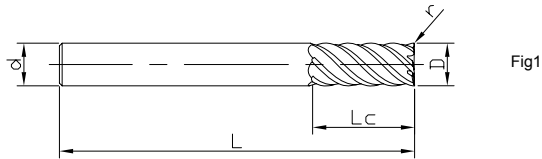

See page 97 for guidelines to icons

Ordering Code	D	Lc	r	L	d	Figure No.	Stock
SH300-R6-06005-H	6	15	0.5	50	6	1	●
SH300-R6-06010-H	6	15	1	50	6	1	○
SH300-R6-08005-H	8	20	0.5	60	8	1	○
SH300-R6-08010-H	8	20	1	60	8	1	○
SH300-R6-08005E-H	8	20	0.5	75	8	1	●
SH300-R6-08010E-H	8	20	1	75	8	1	○
SH300-R6-10005-H	10	25	0.5	75	10	1	○
SH300-R6-10010-H	10	25	1	75	10	1	●
SH300-R6-10020-H	10	25	2	75	10	1	○
SH300-R6-12005-H	12	30	0.5	75	12	1	○
SH300-R6-12010-H	12	30	1	75	12	1	○
SH300-R6-12020-H	12	30	2	75	12	1	○

● Stock ○ Available upon Order

D	Tol
D 12	$\begin{matrix} 0 \\ -0.015 \end{matrix}$
D > 12	$\begin{matrix} 0 \\ -0.02 \end{matrix}$

unit(mm)

Workpiece Material					
P			H		
1	2	3	4	5	6
Carbon Steel, Alloy Steel (< 35HRC)	Alloy Steel (35-48HRC)	PH, Ferrite, MartensiteSteel (< 35HRC)	Hardened Steel (45-55HRC)	Hardened Steel (55-60HRC)	Hardened Steel (> 60HRC)
	○		○	◎	◎

◎ Most Suitable ○ Suitable

Cutting Parameters ※ P464

SH300-R6-H NEW

6 Flute Corner Radius

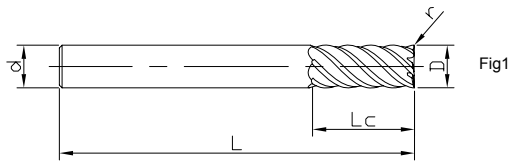

See page 97 for guidelines to icons

» continue

Ordering Code	D	Lc	r	L	d	Figure No.	Stock
SH300-R6-14005-H	14	35	0.5	100	14	1	○
SH300-R6-14010-H	14	35	1	100	14	1	○
SH300-R6-14020-H	14	35	2	100	14	1	○
SH300-R6-16010-H	16	40	1	100	16	1	○
SH300-R6-16020-H	16	40	2	100	16	1	○
SH300-R6-16030-H	16	40	3	100	16	1	○
SH300-R6-20010-H	20	45	1	100	20	1	○
SH300-R6-20020-H	20	45	2	100	20	1	○
SH300-R6-20030-H	20	45	3	100	20	1	○

● Stock ○ Available upon Order

D	Tol
D ≤ 12	0 -0.015
D > 12	0 -0.02

unit(mm)

Workpiece Material

P			H		
1	2	3	4	5	6
Carbon Steel, Alloy Steel (< 35HRC)	Alloy Steel (35-48HRC)	PH, Ferrite, MartensiteSteel (< 35HRC)	Hardened Steel (45-55HRC)	Hardened Steel (55-60HRC)	Hardened Steel (> 60HRC)
	○		○	◎	◎

◎ Most Suitable ○ Suitable

Cutting Parameters ※ P464

SH300-RH6-H NEW

6 Flute Corner Radius, with Long Shank Length

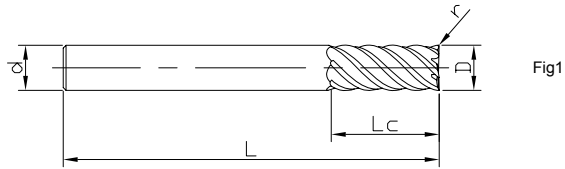

See page 97 for guidelines to icons

Ordering Code	D	Lc	r	L	d	Figure No.	Stock
SH300-RH6-06005-H	6	15	0.5	60	6	1	○
SH300-RH6-06010-H	6	15	1	60	6	1	○
SH300-RH6-06005E-H	6	15	0.5	75	6	1	○
SH300-RH6-06010E-H	6	15	1	75	6	1	○
SH300-RH6-08005-H	8	20	0.5	75	8	1	○
SH300-RH6-08010-H	8	20	1	75	8	1	○
SH300-RH6-10005-H	10	25	0.5	100	10	1	○
SH300-RH6-10010-H	10	25	1	100	10	1	○
SH300-RH6-10020-H	10	25	2	100	10	1	○
SH300-RH6-12005-H	12	30	0.5	100	12	1	○
SH300-RH6-12010-H	12	30	1	100	12	1	●

●Stock ○Available upon Order

D	Tol
D 12	0 -0.015
D > 12	0 -0.02

unit(mm)

Workpiece Material

P			H		
1	2	3	4	5	6
Carbon Steel, Alloy Steel (< 35HRC)	Alloy Steel (35-48HRC)	PH, Ferrite, MartensiteSteel (< 35HRC)	Hardened Steel (45-55HRC)	Hardened Steel (55-60HRC)	Hardened Steel (> 60HRC)
	○		○	⊙	⊙

⊙ Most Suitable ○ Suitable

Cutting Parameters ※ P464

SH300-RH6-H NEW

6 Flute Corner Radius, with Long Shank Length

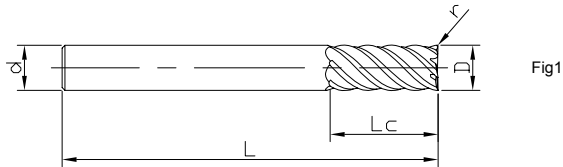

See page 97 for guidelines to icons
) continue

Ordering Code	D	Lc	r	L	d	Figure No.	Stock
SH300-RH6-12020-H	12	30	2	100	12	1	○
SH300-RH6-14005-H	14	35	0.5	120	14	1	○
SH300-RH6-14010-H	14	35	1	120	14	1	○
SH300-RH6-14020-H	14	35	2	120	14	1	○
SH300-RH6-16010-H	16	40	1	120	16	1	○
SH300-RH6-16020-H	16	40	2	120	16	1	○
SH300-RH6-16030-H	16	40	3	120	16	1	○
SH300-RH6-20002-H	20	45	0.2	120	20	1	○
SH300-RH6-20010-H	20	45	1	120	20	1	○
SH300-RH6-20020-H	20	45	2	120	20	1	○
SH300-RH6-20030-H	20	45	3	120	20	1	○

●Stock ○Available upon Order

D	Tol
D 12	0 -0.015
D > 12	0 -0.02

unit(mm)

Workpiece Material					
P			H		
1	2	3	4	5	6
Carbon Steel, Alloy Steel (< 35HRC)	Alloy Steel (35-48HRC)	PH, Ferrite, MartensiteSteel (< 35HRC)	Hardened Steel (45-55HRC)	Hardened Steel (55-60HRC)	Hardened Steel (> 60HRC)
	○		○	◎	◎

◎ Most Suitable ○ Suitable

Cutting Parameters ※ P464

SH300-RL6-H NEW

6 Flute Corner Radius, with Long Flute Length

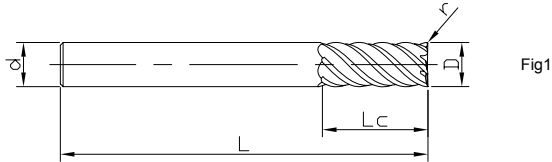

See page 97 for guidelines to icons

Ordering Code	D	Lc	r	L	d	Figure No.	Stock
SH300-RL6-06002E-H	6	25	0.2	100	6	1	○
SH300-RL6-06002F-H	6	45	0.2	120	6	1	○
SH300-RL6-08002E-H	8	35	0.2	100	8	1	○
SH300-RL6-08002F-H	8	45	0.2	100	8	1	○
SH300-RL6-10002E-H	10	45	0.2	120	10	1	○
SH300-RL6-12002E-H	12	45	0.2	150	12	1	○

●Stock ○Available upon Order

D	Tol
D 12	0 -0.015
D > 12	0 -0.02

unit(mm)

Workpiece Material					
P			H		
1	2	3	4	5	6
Carbon Steel, Alloy Steel (< 35HRC)	Alloy Steel (35-48HRC)	PH, Ferrite, MartensiteSteel (< 35HRC)	Hardened Steel (45-55HRC)	Hardened Steel (55-60HRC)	Hardened Steel (> 60HRC)
	○		○	⊙	⊙

⊙ Most Suitable ○ Suitable

Cutting Parameters ※ P464

FH200-R4-H NEW

4 Flute Corner Radius

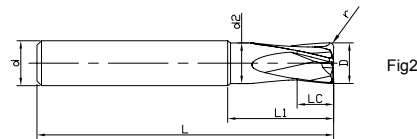
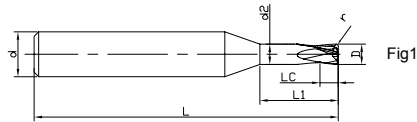

See page 97 for guidelines to icons

Ordering Code	D	Lc	r	d2	L1	L	d	Figure No.	Stock
FH200-R4-01002-H	1	1	0.2	0.95	2	50	4	1	○
FH200-R4-01505-H	1.5	1.5	0.5	1.45	3	50	4	1	○
FH200-R4-02005-H	2	2	0.5	1.9	4	50	6	1	○
FH200-R4-03005-H	3	3	0.5	2.9	6	50	6	1	○
FH200-R4-04005-H	4	4	0.5	3.8	8	60	6	1	●
FH200-R4-05005-H	5	5	0.5	4.7	10	60	6	1	○
FH200-R4-05010-H	5	5	1	4.7	10	60	6	1	○
FH200-R4-06003-H	6	6	0.3	5.7	12	60	6	2	○
FH200-R4-06005-H	6	6	0.5	5.7	12	60	6	2	●
FH200-R4-06010-H	6	6	1	5.7	12	60	6	2	○
FH200-R4-06015-H	6	6	1.5	5.7	12	60	6	2	○

● Stock ○ Available upon Order

D	Tol
D ≤ 5	0 -0.01
D > 5	0 -0.015

unit(mm)

Workpiece Material

P			H		
1	2	3	4	5	6
Carbon Steel, Alloy Steel (< 35HRC)	Alloy Steel (35-48HRC)	PH, Ferrite, MartensiteSteel (< 35HRC)	Hardened Steel (45-55HRC)	Hardened Steel (55-60HRC)	Hardened Steel (> 60HRC)
○	○	○	○	○	○

○ Most Suitable ○ Suitable

Cutting Parameters ※ P466

FH200-R4-H NEW

4 Flute Corner Radius

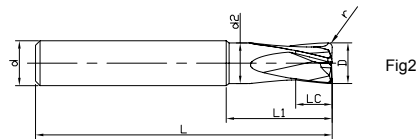
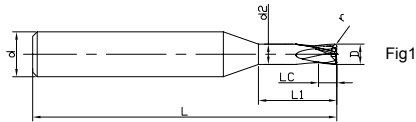

See page 97 for guidelines to icons

» continue

Ordering Code	D	Lc	r	d2	L1	L	d	Figure No.	Stock
FH200-R4-08003-H	8	8	0.3	7.6	16	60	8	2	○
FH200-R4-08005-H	8	8	0.5	7.6	16	60	8	2	○
FH200-R4-08010-H	8	8	1	7.6	16	60	8	2	●
FH200-R4-08020-H	8	8	2	7.6	16	60	8	2	○
FH200-R4-10005-H	10	10	0.5	9.5	20	75	10	2	○
FH200-R4-10010-H	10	10	1	9.5	20	75	10	2	●
FH200-R4-10020-H	10	10	2	9.5	20	75	10	2	○
FH200-R4-12005-H	12	12	0.5	11.5	24	75	12	2	○
FH200-R4-12010-H	12	12	1	11.5	24	75	12	2	○
FH200-R4-12020-H	12	12	2	11.5	24	75	12	2	○
FH200-R4-12030-H	12	12	3	11.5	24	75	12	2	○

●Stock ○Available upon Order

D	Tol
D ≤ 5	0 -0.01
D > 5	0 -0.015

unit(mm)

Workpiece Material

P			H		
1	2	3	4	5	6
Carbon Steel, Alloy Steel (< 35HRC)	Alloy Steel (35-48HRC)	PH, Ferrite, MartensiteSteel (< 35HRC)	Hardened Steel (45-55HRC)	Hardened Steel (55-60HRC)	Hardened Steel (> 60HRC)
	⊙		⊙	⊙	⊙

⊙ Most Suitable ○ Suitable

Cutting Parameters ※ P466

FH200-RN4-H NEW

4 Flute Corner Radius, with Reduced Neck

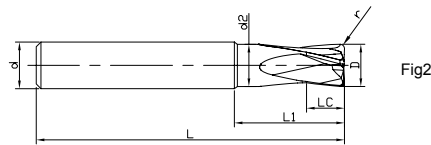
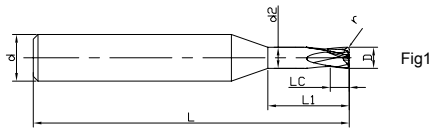

See page 97 for guidelines to icons

Ordering Code	D	Lc	r	d2	L1	L	d	Figure No.	Stock
FH200-R4-06010-H	6	6	1	5.7	12	60	6	2	○
FH200-R4-06015-H	6	6	1.5	5.7	12	60	6	2	○
FH200-RN4-08005-H	8	8	0.5	7.6	24	75	8	2	○
FH200-RN4-08005E-H	8	8	0.5	7.6	24	100	8	2	○
FH200-RN4-08010-H	8	8	1	7.6	24	75	8	2	○
FH200-RN4-08010E-H	8	8	1	7.6	24	100	8	2	○
FH200-RN4-08020-H	8	8	2	7.6	24	75	8	2	○
FH200-RN4-08020E-H	8	8	2	7.6	24	100	8	2	○
FH200-RN4-10005-H	10	10	0.5	9.5	30	100	10	2	○
FH200-RN4-10010-H	10	10	1	9.5	30	100	10	2	○
FH200-RN4-10020-H	10	10	2	9.5	30	100	10	2	○

● Stock ○ Available upon Order

D	Tol
D ≤ 5	0 -0.01
D > 5	0 -0.015

unit(mm)

Workpiece Material

P			H		
1	2	3	4	5	6
Carbon Steel, Alloy Steel (< 35HRC)	Alloy Steel (35-48HRC)	PH, Ferrite, MartensiteSteel (< 35HRC)	Hardened Steel (45-55HRC)	Hardened Steel (55-60HRC)	Hardened Steel (> 60HRC)
⊙	⊙	⊙	⊙	⊙	⊙

⊙ Most Suitable ○ Suitable

Cutting Parameters ※ P466

FH200-RN4-H NEW

4 Flute Corner Radius, with Reduced Neck

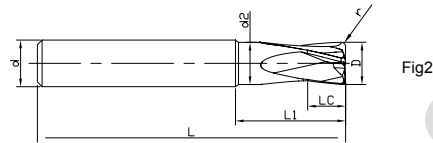
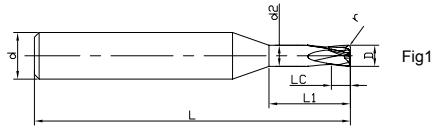

See page 97 for guidelines to icons

» continue

Ordering Code	D	Lc	r	d2	L1	L	d	Figure No.	Stock
FH200-RN4-12005-H	12	12	0.5	11.5	36	100	12	2	○
FH200-RN4-12010-H	12	12	1	11.5	36	100	12	2	○
FH200-RN4-12010E-H	12	12	1	11.5	36	120	12	2	○
FH200-RN4-12020-H	12	12	2	11.5	36	100	12	2	○
FH200-RN4-12020E-H	12	12	2	11.5	36	120	12	2	○
FH200-RN4-12030-H	12	12	3	11.5	36	100	12	2	○
FH200-RN4-12030E-H	12	12	3	11.5	36	120	12	2	○

●Stock ○Available upon Order

D	Tol
D ≤ 5	0 -0.01
D > 5	0 -0.015

unit(mm)

Workpiece Material					
P			H		
1	2	3	4	5	6
Carbon Steel, Alloy Steel (< 35HRC)	Alloy Steel (35-48HRC)	PH, Ferrite, MartensiteSteel (< 35HRC)	Hardened Steel (45-55HRC)	Hardened Steel (55-60HRC)	Hardened Steel (> 60HRC)
	⊙		⊙	⊙	⊙

⊙ Most Suitable ○ Suitable

Cutting Parameters ※ P466

FH200-R6-H NEW

6 Flute Corner Radius

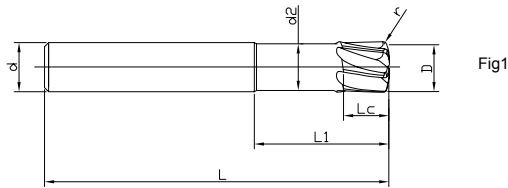

See page 97 for guidelines to icons

Ordering Code	D	Lc	r	d2	L1	L	d	Figure No.	Stock
FH200-R6-06004-H	6	5	0.375	5.5	18	60	6	1	●
FH200-R6-08005-H	8	7	0.5	7.5	24	75	8	1	●
FH200-R6-10006-H	10	8	0.625	9.5	30	90	10	1	●
FH200-R6-12008-H	12	10	0.75	11.5	36	100	12	1	●
FH200-R6-16010-H	16	14	1	15.5	48	110	16	1	○
FH200-R6-20013-H	20	18	1.25	19.5	60	125	20	1	○

●Stock ○Available upon Order

D	Tol
D 20	-0.014 -0.038

unit(mm)

Workpiece Material					
P			H		
1	2	3	4	5	6
Carbon Steel, Alloy Steel (< 35HRC)	Alloy Steel (35-48HRC)	PH, Ferrite, MartensiteSteel (< 35HRC)	Hardened Steel(45- 55HRC)	Hardened Steel (55-60HRC)	Hardened Steel (> 60HRC)
	⊙		⊙	⊙	⊙

⊙ Most Suitable ○ Suitable

Cutting Parameters ※ P467

FH200-RH6-H NEW

6 Flute Corner Radius, with Long Shank Length

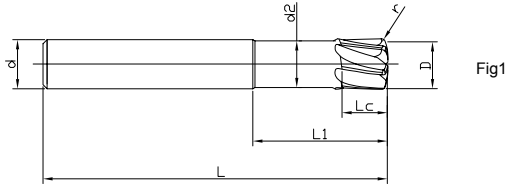

See page 97 for guidelines to icons

Ordering Code	D	Lc	r	d2	L1	L	d	Figure No.	Stock
FH200-RH6-06004-H	6	5	0.375	5.5	18	100	6	1	○
FH200-RH6-08005-H	8	7	0.5	7.5	24	100	8	1	○
FH200-RH6-10006-H	10	8	0.625	9.5	30	120	10	1	○
FH200-RH6-12008-H	12	10	0.75	11.5	36	120	12	1	○
FH200-RH6-16010-H	16	14	1	15.5	48	150	16	1	○
FH200-RH6-20013-H	20	18	1.25	19.5	60	150	20	1	○

●Stock ○Available upon Order

D	Tol
D 20	-0.014 -0.038

unit(mm)

Workpiece Material					
P			H		
1 2 3 4	5	6	1	2	3 4
Carbon Steel, Alloy Steel (< 35HRC)	Alloy Steel (35-48HRC)	PH, Ferrite, MartensiteSteel (< 35HRC)	Hardened Steel (45-55HRC)	Hardened Steel (55-60HRC)	Hardened Steel (> 60HRC)
	⊙		⊙	⊙	⊙

⊙ Most Suitable ○ Suitable

Cutting Parameters ※ P467

FH200-RN6-H NEW

6 FluteCorner Radius, with Reduced Neck

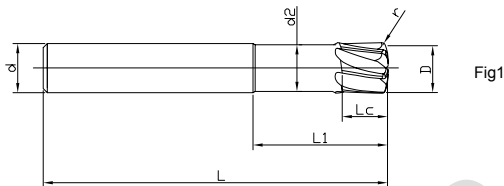

See page 97 for guidelines to icons

Ordering Code	D	Lc	r	d2	L1	L	d	Figure No.	Stock
FH200-RH6-06004-H	6	5	0.375	5.5	18	100	6	1	○
FH200-RH6-08005-H	8	7	0.5	7.5	24	100	8	1	○
FH200-RH6-10006-H	10	8	0.625	9.5	30	120	10	1	○
FH200-RH6-12008-H	12	10	0.75	11.5	36	120	12	1	○
FH200-RH6-16010-H	16	14	1	15.5	48	150	16	1	○
FH200-RH6-20013-H	20	18	1.25	19.5	60	150	20	1	○

●Stock ○Available upon Order

D	Tol
D 20	-0.014 -0.038

unit(mm)

Workpiece Material					
P			H		
1	2	3	4	5	6
Carbon Steel, Alloy Steel (< 35HRC)	Alloy Steel (35-48HRC)	PH, Ferrite, MartensiteSteel (< 35HRC)	Hardened Steel (45-55HRC)	Hardened Steel (55-60HRC)	Hardened Steel (> 60HRC)
⊙	⊙	⊙	⊙	⊙	⊙

⊙ Most Suitable ○ Suitable

Cutting Parameters ※ P467

UP100-B2

2 Flute, Ballnose

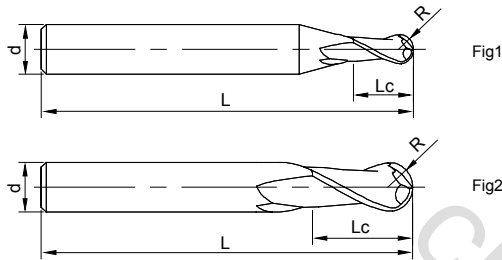

See page 97 for guidelines to icons

Ordering Code	D	R	Lc	L	d	Figure No.	Stock
UP100-B2-00601	0.6	0.3	1.2	50	4	1	●
UP100-B2-00801	0.8	0.4	1.6	50	4	1	○
UP100-B2-00901	0.9	0.45	1.8	50	4	1	○
UP100-B2-01002	1	0.5	2	50	4	1	●
UP100-B2-01503	1.5	0.75	3	50	4	1	○
UP100-B2-02004	2	1	4	50	4	1	●
UP100-B2-02505	2.5	1.25	5	50	4	1	○
UP100-B2-03006	3	1.5	6	50	4	1	●
UP100-B2-63006	3	1.5	6	50	6	1	○
UP100-B2-63508	3.5	1.75	8	50	6	1	●
UP100-B2-04008	4	2	8	50	4	2	○
UP100-B2-64008	4	2	8	50	6	1	●

● Stock ○ Available upon Order

R	Tol
R 1.5	$\begin{matrix} 0 \\ -0.01 \end{matrix}$
1.5 < R < 3	$\begin{matrix} 0 \\ -0.015 \end{matrix}$
R 3	$\begin{matrix} 0 \\ -0.02 \end{matrix}$

unit(mm)

Workpiece Material

P		M	K	N		
1234	5	123	123	123	4	5
Carbon Steel, Alloy Steel(<35 HRC)	Alloy Steel, Tool Steel(<48HRC)	Stainless Steel	Cast Iron	Aluminium Alloys	Copper Alloys	Graphite
⊙	○	○	⊙	○	○	

⊙ Most Suitable ○ Suitable

Cutting Parameters ※ P424

UP100-B2

2 Flute, Ballnose

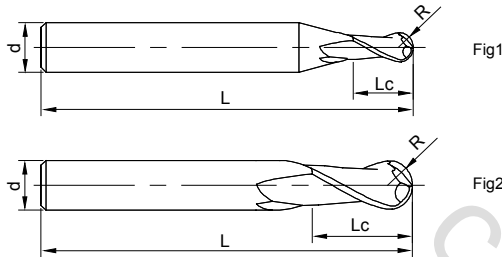

See page 97 for guidelines to icons

» continue

Ordering Code	D	R	Lc	L	d	Figure No.	Stock
UP100-B2-05010	5	2.5	10	50	6	1	●
UP100-B2-06012	6	3	12	50	6	2	●
UP100-B2-07014	7	3.5	14	60	8	1	○
UP100-B2-08014	8	4	14	60	8	2	○
UP100-B2-09016	9	4.5	16	75	10	1	○
UP100-B2-10018	10	5	18	75	10	2	○
UP100-B2-11020	11	5.5	20	75	12	1	○
UP100-B2-12022	12	6	22	75	12	2	○
UP100-B2-13026	13	6.5	26	90	16	1	○
UP100-B2-14026	14	7	26	90	16	1	○
UP100-B2-15030	15	7.5	30	90	16	1	○
UP100-B2-16030	16	8	30	100	16	2	○
UP100-B2-20038	20	10	38	100	20	2	○

●Stock ○Available upon Order

R	Tol
R 1.5	$\begin{matrix} 0 \\ -0.01 \end{matrix}$
1.5<R<3	$\begin{matrix} 0 \\ -0.015 \end{matrix}$
R 3	$\begin{matrix} 0 \\ -0.02 \end{matrix}$

unit(mm)

Workpiece Material						
P		M	K	N		
1234	5	123	123	123	4	5
Carbon Steel, Alloy Steel(<35 HRC)	Alloy Steel, Tool Steel(<48HRC)	Stainless Steel	Cast Iron	Aluminium Alloys	Copper Alloys	Graphite
⊙	○	○	⊙	○	○	

⊙ Most Suitable ○ Suitable

Cutting Parameters ※ P424

UP100-BH2

2 Flute Ballnose with Long Shank Length

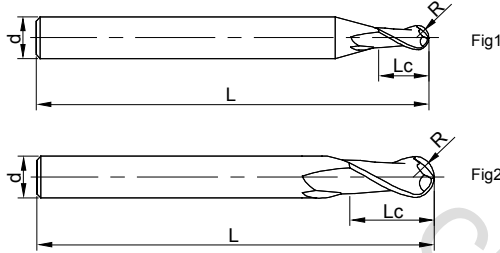

See page 97 for guidelines to icons

Ordering Code	D	R	Lc	L	d	Figure No.	Stock
UP100-BH2-02004	2	1	4	75	4	1	○
UP100-BH2-03006	3	1.5	6	75	4	1	○
UP100-BH2-04008	4	2	8	75	4	2	○
UP100-BH2-05010	5	2.5	10	75	6	1	○
UP100-BH2-06012	6	3	12	100	6	2	●
UP100-BH2-08016	8	4	16	100	8	2	●
UP100-BH2-10020	10	5	20	150	10	2	●
UP100-BH2-12024	12	6	24	150	12	2	●

●Stock ○Available upon Order

R	Tol
R 1.5	$\begin{matrix} 0 \\ -0.01 \end{matrix}$
1.5<R<3	$\begin{matrix} 0 \\ -0.015 \end{matrix}$
R 3	$\begin{matrix} 0 \\ -0.02 \end{matrix}$

unit(mm)

Workpiece Material

P		M	K	N		
1234	5	123	123	123	4	5
Carbon Steel, Alloy Steel(<35 HRC)	Alloy Steel, Tool Steel(48HRC)	Stainless Steel	Cast Iron	Aluminium Alloys	Copper Alloys	Graphite
⊙	○	○	⊙	○	○	

⊙ Most Suitable ○ Suitable

Cutting Parameters ※ P424

UP100-B4

4 Flute, Ballnose

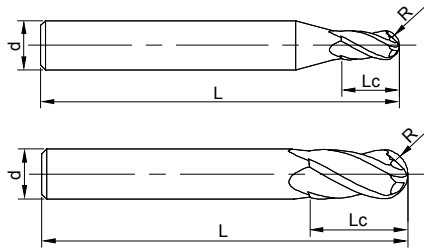

Fig1

Fig2



See page 97 for guidelines to icons

Ordering Code	D	R	Lc	L	d	Figure No.	Stock
UP100-B4-02004	2	1	4	50	4	1	○
UP100-B4-02505	2.5	1.25	5	50	4	1	●
UP100-B4-03006	3	1.5	6	50	4	1	●
UP100-B4-63006	3	1.5	6	50	6	1	●
UP100-B4-04008	4	2	8	50	4	2	●
UP100-B4-64008	4	2	8	50	6	1	●
UP100-B4-05010	5	2.5	10	50	6	1	●
UP100-B4-06012	6	3	12	50	6	2	●
UP100-B4-07014	7	3.5	14	60	8	1	●
UP100-B4-08014	8	4	14	60	8	2	●
UP100-B4-09016	9	4.5	16	75	10	1	●
UP100-B4-10018	10	5	18	75	10	2	●
UP100-B4-11020	11	5.5	20	75	12	1	●
UP100-B4-12022	12	6	22	75	12	2	●
UP100-B4-14024	14	7	24	75	14	2	○
UP100-B4-16030	16	8	30	100	16	2	○
UP100-B4-20038	20	10	38	100	20	2	○

●Stock ○Available upon Order

R	Tol
R 1.5	$\begin{matrix} 0 \\ -0.01 \end{matrix}$
1.5<R<3	$\begin{matrix} 0 \\ -0.015 \end{matrix}$
R 3	$\begin{matrix} 0 \\ -0.02 \end{matrix}$

unit(mm)

Workpiece Material						
P		M	K	N		
1234	5	123	123	123	4	5
Carbon Steel, Alloy Steel(<35 HRC)	Alloy Steel, Tool Steel(48HRC)	Stainless Steel	Cast Iron	Aluminium Alloys	Copper Alloys	Graphite
⊙	○	○	⊙	○	○	

⊙ Most Suitable ○ Suitable

Cutting Parameters ※ P424

UP210-B2

2 Flute, Ballnose

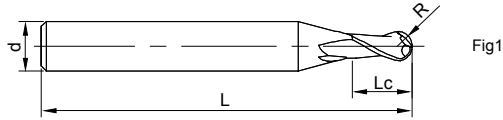

Fig1

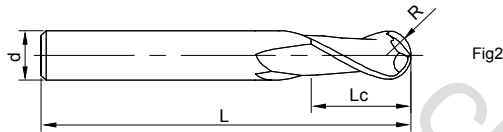

Fig2



See page 97 for guidelines to icons

Ordering Code	D	R	Lc	L	d	Figure No.	Stock
UP210-B2-00801	0.8	0.4	1.6	50	4	1	○
UP210-B2-00901	0.9	0.45	1.8	50	4	1	○
UP210-B2-01002	1	0.5	2	50	4	1	●
UP210-B2-01503	1.5	0.75	3	50	4	1	●
UP210-B2-02004	2	1	4	50	4	1	●
UP210-B2-62004	2	1	4	50	6	1	●
UP210-B2-02505	2.5	1.25	5	50	4	1	○
UP210-B2-03006	3	1.5	6	50	4	1	●
UP210-B2-63006	3	1.5	6	50	6	1	●
UP210-B2-04008	4	2	8	50	4	2	●
UP210-B2-64008	4	2	8	50	6	1	●
UP210-B2-05010	5	2.5	10	50	6	1	●
UP210-B2-05510	5.5	2.75	10	50	6	1	○

●Stock ○Available upon Order

R	Tol
R 1.5	$\begin{matrix} 0 \\ -0.01 \end{matrix}$
1.5<R<3	$\begin{matrix} 0 \\ -0.015 \end{matrix}$
R 3	$\begin{matrix} 0 \\ -0.02 \end{matrix}$

unit (mm)

Workpiece Material

P		M	K	N		
1234	5	123	123	123	4	5
Carbon Steel, Alloy Steel(<35 HRC)	Alloy Steel, Tool Steel(<48HRC)	Stainless Steel	Cast Iron	Aluminium Alloys	Copper Alloys	Graphite
⊙	⊙	○	⊙			

⊙ Most Suitable ○ Suitable

Cutting Parameters ※ P428

UP210-B2

2 Flute, Ballnose

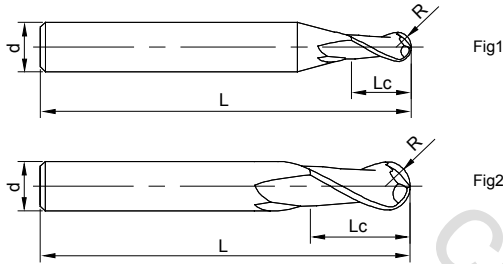

See page 97 for guidelines to icons

» continue

Ordering Code	D	R	Lc	L	d	Figure No.	Stock
UP210-B2-06012	6	3	12	50	6	2	●
UP210-B2-07014	7	3.5	14	60	8	1	●
UP210-B2-08014	8	4	14	60	8	2	●
UP210-B2-09016	9	4.5	16	75	10	1	●
UP210-B2-10018	10	5	18	75	10	2	●
UP210-B2-11020	11	5.5	20	75	12	1	○
UP210-B2-12022	12	6	22	75	12	2	●
UP210-B2-13026	13	6.5	26	90	14	1	○
UP210-B2-14026	14	7	26	90	14	2	●
UP210-B2-15030	15	7.5	30	100	16	1	○
UP210-B2-16030	16	8	30	100	16	2	●
UP210-B2-18034	18	9	34	100	18	2	○
UP210-B2-20038	20	10	38	100	20	2	●

● Stock ○ Available upon Order

R	Tol
R 1.5	$\begin{matrix} 0 \\ -0.01 \end{matrix}$
1.5<R<3	$\begin{matrix} 0 \\ -0.015 \end{matrix}$
R 3	$\begin{matrix} 0 \\ -0.02 \end{matrix}$

unit (mm)

Workpiece Material						
P		M	K	N		
1234	5	123	123	123	4	5
Carbon Steel, Alloy Steel(<35 HRC)	Alloy Steel, Tool Steel(<48HRC)	Stainless Steel	Cast Iron	Aluminium Alloys	Copper Alloys	Graphite
⊙	⊙	○	⊙			

⊙ Most Suitable ○ Suitable

Cutting Parameters ※ P428

UP210-BH2

2 Flute Ballnose with Long Shank Length

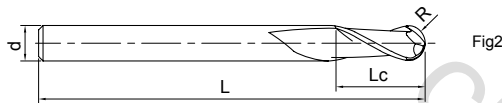
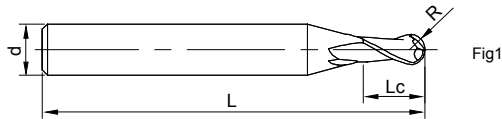

See page 97 for guidelines to icons

Ordering Code	D	R	Lc	L	d	Figure No.	Stock
UP210-BH2-02004	2	1	4	75	4	1	●
UP210-BH2-03006	3	1.5	6	75	4	1	●
UP210-BH2-63006	3	1.5	6	75	6	1	●
UP210-BH2-04008	4	2	8	75	4	2	●
UP210-BH2-64008	4	2	8	75	6	1	●
UP210-BH2-05010	5	2.5	10	75	6	1	●
UP210-BH2-06012	6	3	12	75	6	2	●
UP210-BH2-07014	7	3.5	14	100	8	1	○
UP210-BH2-08014	8	4	14	100	8	2	●
UP210-BH2-09016	9	4.5	16	100	10	1	○
UP210-BH2-10018	10	5	18	100	10	2	●
UP210-BH2-11020	11	5.5	20	100	12	1	○
UP210-BH2-12022	12	6	22	100	12	2	●
UP210-BH2-14026	14	7	26	150	14	2	○
UP210-BH2-16030	16	8	30	150	16	2	●
UP210-BH2-18034	18	9	34	150	18	2	○
UP210-BH2-20038	20	10	38	150	20	2	●

●Stock ○Available upon Order

R	Tol
R 1.5	0 -0.01
1.5<R<3	0 -0.015
R 3	0 -0.02

unit(mm)

Workpiece Material						
P		M	K	N		
1234	5	123	123	123	4	5
Carbon Steel, Alloy Steel(<35 HRC)	Alloy Steel, Tool Steel(<48HRC)	Stainless Steel	Cast Iron	Aluminium Alloys	Copper Alloys	Graphite
⊙	⊙	○	⊙			

⊙ Most Suitable ○ Suitable

Cutting Parameters ※ P428

UP210-B4

4 Flute, Ballnose

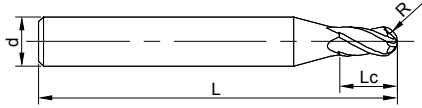

Fig1



Fig2



See page 97 for guidelines to icons

Ordering Code	D	R	Lc	L	d	Figure No.	Stock
UP210-B4-02004	2	1	4	50	4	1	○
UP210-B4-02505	2.5	1.25	5	50	4	1	○
UP210-B4-03006	3	1.5	6	50	4	1	○
UP210-B4-63006	3	1.5	6	50	6	1	○
UP210-B4-04008	4	2	8	50	4	2	○
UP210-B4-64008	4	2	8	50	6	1	○
UP210-B4-05010	5	2.5	10	50	6	1	●
UP210-B4-06012	6	3	12	50	6	2	○
UP210-B4-07014	7	3.5	14	60	8	1	○

●Stock ○Available upon Order

R	Tol
R 1.5	0 -0.01
1.5<R<3	0 -0.015
R 3	0 -0.02

unit(mm)

Workpiece Material

P		M	K	N		
1234	5	123	123	123	4	5
Carbon Steel, Alloy Steel(<35 HRC)	Alloy Steel, Tool Steel(<48HRC)	Stainless Steel	Cast Iron	Aluminium Alloys	Copper Alloys	Graphite
◎	◎	○	◎			

◎ Most Suitable ○ Suitable

Cutting Parameters ※ P428

UP210-B4

4 Flute, Ballnose

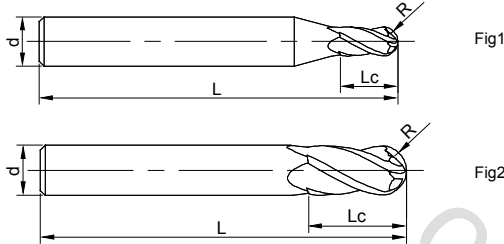

See page 97 for guidelines to icons

Ordering Code	D	R	Lc	L	d	Figure No.	Stock
UP210-B4-08014	8	4	14	60	8	2	●
UP210-B4-09016	9	4.5	16	75	10	1	○
UP210-B4-10018	10	5	18	75	10	2	○
UP210-B4-11020	11	5.5	20	75	12	1	○
UP210-B4-12022	12	6	22	75	12	2	●
UP210-B4-14024	14	7	24	75	14	2	○
UP210-B4-16030	16	8	30	100	16	2	○
UP210-B4-18034	18	9	34	100	18	2	○
UP210-B4-20038	20	10	38	100	20	2	○

● Stock ○ Available upon Order

R	Tol
R 1.5	$\begin{matrix} 0 \\ -0.01 \end{matrix}$
1.5 < R < 3	$\begin{matrix} 0 \\ -0.015 \end{matrix}$
R 3	$\begin{matrix} 0 \\ -0.02 \end{matrix}$

unit(mm)

Workpiece Material						
P		M	K	N		
1234	5	123	123	123	4	5
Carbon Steel, Alloy Steel(<35 HRC)	Alloy Steel, Tool Steel(<48HRC)	Stainless Steel	Cast Iron	Aluminium Alloys	Copper Alloys	Graphite
◎	◎	○	◎			

◎ Most Suitable ○ Suitable

Cutting Parameters ※ P428

SP210-B2

2 Flute, Ballnose

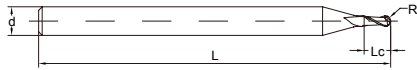

Fig1

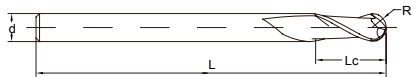

Fig2



See page 97 for guidelines to icons

Ordering Code	D	R	Lc	L	d	Figure No.	Stock
SP210-B2-01002	1	0.5	2	50	4	1	●
SP210-B2-01503	1.5	0.75	3	50	4	1	●
SP210-B2-02004	2	1	4	50	4	1	●
SP210-B2-03006	3	1.5	6	50	4	1	●
SP210-B2-04008	4	2	8	50	4	2	●
SP210-B2-06012	6	3	12	50	6	2	●
SP210-B2-08014	8	4	14	60	8	2	●
SP210-B2-10018	10	5	18	75	10	2	●
SP210-B2-11020	11	5.5	20	75	12	1	●
SP210-B2-12022	12	6	22	75	12	2	●

● Stock ◦ Available upon Order

R	Tol
R 1.5	$\begin{matrix} 0 \\ -0.01 \end{matrix}$
1.5 < R < 3	$\begin{matrix} 0 \\ -0.015 \end{matrix}$
R 3	$\begin{matrix} 0 \\ -0.02 \end{matrix}$

unit(mm)

Workpiece Material						
P		M	K	N		
1234	5	123	123	123	4	5
Carbon Steel, Alloy Steel(<35 HRC)	Alloy Steel, Tool Steel(<48HRC)	Stainless Steel	Cast Iron	Aluminium Alloys	Copper Alloys	Graphite
⊙	⊙	○	⊙			

⊙ Most Suitable ○ Suitable

Cutting Parameters ※ P431

SP210-BH2

2 Flute, Ballnose with Long Shank Length

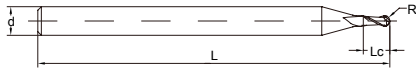

Fig1

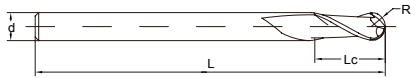

Fig2



See page 97 for guidelines to icons

Ordering Code	D	R	Lc	L	d	Figure No.	Stock
SP210-BH2-61002	1	0.5	2	75	6	1	●
SP210-BH2-61503	1.5	0.75	3	75	6	1	●
SP210-BH2-62004	2	1	4	75	6	1	●
SP210-BH2-63006	3	1.5	6	75	6	1	●
SP210-BH2-04008	4	2	8	75	4	2	●
SP210-BH2-64008	4	2	8	75	6	1	●
SP210-BH2-06012	6	3	12	75	6	2	●
SP210-BH2-08014	8	4	14	75	8	2	●
SP210-BH2-10018	10	5	18	100	10	2	●
SP210-BH2-12022	12	6	22	100	12	2	●

●Stock ◦Available upon Order

R	Tol
R 1.5	0 -0.01
1.5<R<3	0 -0.015
R 3	0 -0.02

unit(mm)

Workpiece Material

P		M	K	N		
1234	5	123	123	123	4	5
Carbon Steel, Alloy Steel(<35 HRC)	Alloy Steel, Tool Steel(<48HRC)	Stainless Steel	Cast Iron	Aluminium Alloys	Copper Alloys	Graphite
⊙	⊙	○	⊙			

⊙ Most Suitable ○ Suitable

Cutting Parameters ※ P431

UPM100-BN2

2 Flute Ballnose, Miniature Sizes with Reduced Neck

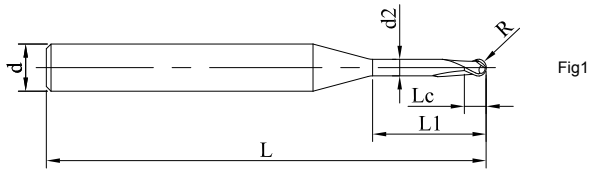

See page 97 for guidelines to icons

Ordering Code	D	R	Lc	d2	L1	L	d	Figure No.	Stock
UPM100-BN2-00802	0.8	0.4	0.6	0.75	2	50	4	1	○
UPM100-BN2-00804	0.8	0.4	0.6	0.75	4	50	4	1	○
UPM100-BN2-00806	0.8	0.4	0.6	0.75	6	50	4	1	●
UPM100-BN2-01006	1.0	0.5	0.8	0.95	6	50	4	1	○
UPM100-BN2-01008	1.0	0.5	0.8	0.95	8	50	4	1	○
UPM100-BN2-01010	1.0	0.5	0.8	0.95	10	50	4	1	●
UPM100-BN2-01206	1.2	0.6	1.0	1.15	6	50	4	1	○
UPM100-BN2-01208	1.2	0.6	1.0	1.15	8	50	4	1	○
UPM100-BN2-01210	1.2	0.6	1.0	1.15	10	50	4	1	●
UPM100-BN2-01508	1.5	0.75	1.4	1.44	8	50	4	1	○
UPM100-BN2-01510	1.5	0.75	1.4	1.44	10	50	4	1	○
UPM100-BN2-01512	1.5	0.75	1.4	1.44	12	50	4	1	●
UPM100-BN2-02008	2.0	1.0	1.6	1.92	8	50	4	1	○
UPM100-BN2-02010	2.0	1.0	1.6	1.92	10	50	4	1	○
UPM100-BN2-02012	2.0	1.0	1.6	1.92	12	50	4	1	●

● Stock ○ Available upon Order

R	Tol
0.4 R 1	±0.015

unit(mm)

Workpiece Material						
P		M	K	N		
1234	5	123	123	123	4	5
Carbon Steel, Alloy Steel(<35 HRC)	Alloy Steel, Tool Steel(<48HRC)	Stainless Steel	Cast Iron	Aluminium Alloys	Copper Alloys	Graphite
◎	○	○	◎			

◎ Most Suitable ○ Suitable

Cutting Parameters ※ P436

US200-B2

2 Flute, Ballnose

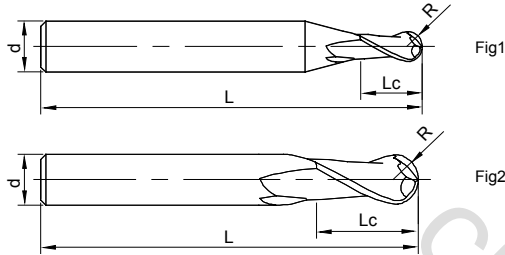

See page 97 for guidelines to icons

Ordering Code	D	R	Lc	L	d	Figure No.	Stock
US200-B2-01002	1	0.5	2	50	4	1	○
US200-B2-01503	1.5	0.75	3	50	4	1	○
US200-B2-02004	2	1	4	50	4	1	○
US200-B2-03006	3	1.5	6	50	4	1	○
US200-B2-63006	3	1.5	6	50	6	1	●
US200-B2-04008	4	2	8	50	4	2	●
US200-B2-64008	4	2	8	50	6	1	●
US200-B2-05010	5	2.5	10	50	6	1	●
US200-B2-06012	6	3	12	50	6	2	●
US200-B2-08014	8	4	14	60	8	2	●
US200-B2-10018	10	5	18	75	10	2	●
US200-B2-12022	12	6	22	75	12	2	●
US200-B2-16026	16	8	26	100	16	2	●
US200-B2-20038	20	10	38	100	20	2	●

●Stock ○Available upon Order

D	Tol
D 12	$\begin{matrix} 0 \\ -0.02 \end{matrix}$
D > 12	$\begin{matrix} 0 \\ -0.03 \end{matrix}$

unit(mm)

Workpiece Material

P		M	K	S	
1234	5	123	123	123	4
Carbon Steel, Alloy Steel(<35HRC)	Alloy Steel, Tool Steel(<48HRC)	Stainless Steel	Cast Iron	Heat-resistant Alloys	Titanium Alloys
○	○	⊙	○	○	○

⊙ Most Suitable ○ Suitable

Cutting Parameters ※ P438

US200-B4

4 Flute, Ballnose

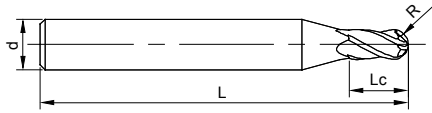

Fig1

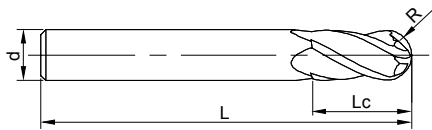

Fig2



See page 97 for guidelines to icons

Ordering Code	D	R	Lc	L	d	Figure No.	Stock
US200-B4-01002	1	0.5	2	50	4	1	●
US200-B4-01503	1.5	0.75	3	50	4	1	●
US200-B4-02004	2	1	4	50	4	1	○
US200-B4-03006	3	1.5	6	50	4	1	●
US200-B4-04008	4	2	8	50	4	2	●
US200-B4-05010	5	2.5	10	50	6	1	○
US200-B4-06012	6	3	12	50	6	2	○
US200-B4-08014	8	4	14	60	8	2	●
US200-B4-10018	10	5	18	75	10	2	●
US200-B4-12022	12	6	22	75	12	2	○
US200-B4-16026	16	8	26	100	16	2	○
US200-B4-20038	20	10	38	100	20	2	○
US200-B4-63006	3	1.5	6	50	6	1	○
US200-B4-64008	4	2	8	50	4	2	○

● Stock ○ Available upon Order

D	Tol
D 12	0 -0.02
D > 12	0 -0.03

unit(mm)

Workpiece Material

P		M	K	S	
1234	5	123	123	123	4
Carbon Steel, Alloy Steel(<35HRC)	Alloy Steel, Tool Steel(<48HRC)	Stainless Steel	Cast Iron	Heat-resistant Alloys	Titanium Alloys
○	○	⊙	○	○	○

● Most Suitable ○ Suitable

Cutting Parameters ※ P438

UA100-B2

2 Flute, Ballnose

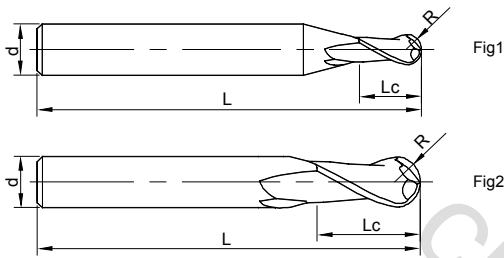

See page 97 for guidelines to icons

Ordering Code	D	R	Lc	L	d	Figure No.	Stock
UA100-B2-01002	1	0.5	2	50	4	1	○
UA100-B2-02004	2	1	4	50	4	1	○
UA100-B2-03006	3	1.5	6	50	4	1	●
UA100-B2-63006	3	1.5	6	50	6	1	●
UA100-B2-04008	4	2	8	50	4	2	●
UA100-B2-64008	4	2	8	50	6	1	○
UA100-B2-05010	5	2.5	10	50	6	1	●
UA100-B2-06012	6	3	12	50	6	2	○
UA100-B2-07014	7	3.5	14	60	8	1	●
UA100-B2-08014	8	4	14	60	8	2	●
UA100-B2-09016	9	4.5	16	75	10	1	●
UA100-B2-10018	10	5	18	75	10	2	○
UA100-B2-12022	12	6	22	75	12	2	●
UA100-B2-16026	16	8	26	100	16	2	○

● Stock ○ Available upon Order

D	Tol
D ≤ 12	0 -0.02
D > 12	0 -0.03

unit(mm)

Workpiece Material

P		M	K	S	
1234	5	123	123	123	4
Carbon Steel, Alloy Steel(<35HRC)	Alloy Steel, Tool Steel(<48HRC)	Stainless Steel	Cast Iron	Heat-resistant Alloys	Titanium Alloys
			⊙	⊙	

● Most Suitable ○ Suitable

Cutting Parameters ※ P443

SA300-BN2

2 Flute Ballnose with Reduced Neck

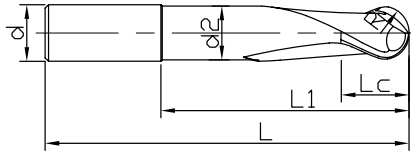
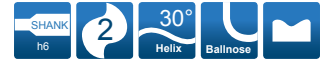

Fig1



See page 97 for guidelines to icons

Ordering Code	D	R	Lc	L1	d2	L	d	Figure No.	Stock
SA300-BN2-10030	10	5	12	30	9.5	70	10	1	○
SA300-BN2-12036	12	6	14	36	11.5	80	12	1	○
SA300-BN2-16048	16	8	18	48	15	100	16	1	○
SA300-BN2-20060	20	10	24	60	19	112	20	1	○

● Stock ○ Available upon Order

R	Tol
R 10	±0.02

unit(mm)

Workpiece Material						
P		M	K	N		
1234	5	123	123	123	4	5
Carbon Steel, Alloy Steel(<35HRC)	Alloy Steel, Tool Steel(<48HRC)	Stainless Steel	Cast Iron	Aluminium Alloys	Copper Alloys	Graphite
				⊙	⊙	

● Most Suitable ○ Suitable

Cutting Parameters ※ P447

SG200-B2

2 Flute, Ballnose

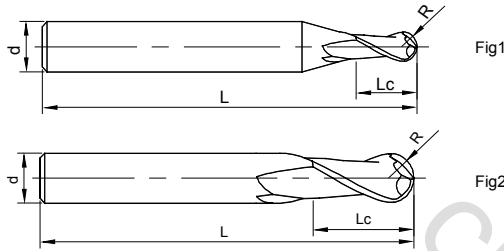

See page 97 for guidelines to icons

Ordering Code	D	R	Lc	L	d	Figure No.	Stock
SG200-B2-01002	1	0.5	2	50	4	1	○
SG200-B2-01503	1.5	0.75	3	50	4	1	○
SG200-B2-02004	2	1	4	50	4	1	●
SG200-B2-03006	3	1.5	6	50	4	1	○
SG200-B2-04008	4	2	8	50	4	2	○
SG200-B2-05010	5	2.5	10	50	6	1	○
SG200-B2-06012	6	3	12	50	6	2	●
SG200-B2-08014	8	4	14	60	8	2	○
SG200-B2-10018	10	5	18	75	10	2	○
SG200-B2-12022	12	6	22	75	12	2	○

● Stock ○ Available upon Order

D	Tol
R < 3	0 -0.02
3 R 6	0 -0.03

unit(mm)

Workpiece Material

P		M	K	S	
1234	5	123	123	123	4
Carbon Steel, Alloy steel (< 35HRC)	Alloy steel, Tool steel (< HRC48)	Stainless Steel	Cast Iron	Heat-resistant Super Alloys	Heat-resistant Super Alloys
			○	○	◎

● Most Suitable ○ Suitable

Cutting Parameters ※ P450

SG200-BN2

2 Flute Ballnose with Reduced Neck

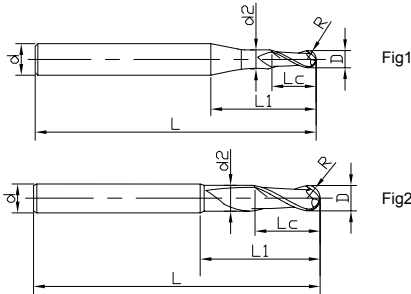

See page 97 for guidelines to icons

Ordering Code	D	R	Lc	L1	D1	L	d	Figure No.	Stock
SG200-BN2-01010	1	0.5	3	10	0.95	50	4	1	●
SG200-BN2-01515	1.5	0.75	3	15	1.44	50	4	1	○
SG200-BN2-02020	2	1	4	20	1.92	75	4	1	●
SG200-BN2-03015	3	1.5	6	15	2.9	50	4	1	○
SG200-BN2-03020	3	1.5	6	20	2.9	75	4	1	○
SG200-BN2-04012	4	2	8	12	3.9	60	4	2	○
SG200-BN2-04020	4	2	8	20	3.9	60	4	2	●
SG200-BN2-06018	6	3	12	18	5.9	75	6	2	○
SG200-BN2-06030	6	3	12	30	5.9	75	6	2	○
SG200-BN2-08024	8	4	14	24	7.9	100	8	2	○
SG200-BN2-08040	8	4	14	40	7.9	100	8	2	○
SG200-BN2-10030	10	5	18	30	9.8	100	10	2	○
SG200-BN2-10050	10	5	18	50	9.8	100	10	2	○
SG200-BN2-12035	12	6	22	35	11.8	100	12	2	○
SG200-BN2-12050	12	6	22	50	11.8	100	12	2	○

● Stock ○ Available upon Order

D	Tol
R < 3	0 -0.02
3 R 6	0 -0.03

unit(mm)

Workpiece Material					
P	M	K	S		
1234	5	123	123	123	4
Carbon Steel, Alloy steel (< 35HRC)	Alloy steel, Tool steel (< HRC48)	Stainless Steel	Cast Iron	Heat-resistant Super Alloys	Heat-resistant Super Alloys
			○	○	◎

● Most Suitable ○ Suitable

Cutting Parameters ※ P450

SN200-B4

4 Flute Ballnose, with Unequal Flute Spacing

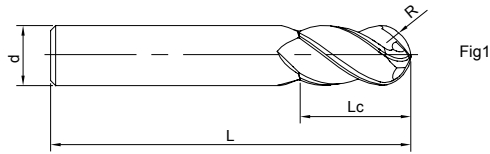

See page 97 for guidelines to icons

Ordering Code	D	R	Lc	L	d	Figure No.	Stock
SN200-B4-06012	6	3	12	50	6	1	○
SN200-B4-08014	8	4	14	60	8	1	○
SN200-B4-10018	10	5	18	75	10	1	○
SN200-B4-12022	12	6	22	75	12	1	○
SN200-B4-16026	16	8	26	90	16	1	○

●Stock ○Available upon Order

R	Tol
R 3	±0.020

unit(mm)

Workpiece Material				
P	M	S		
1234	5	123	123	4
Carbon Steel, Alloy steel (< 35HRC)	Alloy steel, Tool steel (< HRC48)	Stainless Steel	Heat-resistant Super Alloys	Titanium Alloys
○	○	○	⊙	○

● Most Suitable ○ Suitable

Cutting Parameters ※ P453

ST200-B4

4 Flute Ballnose, with Unequal Flute Spacing

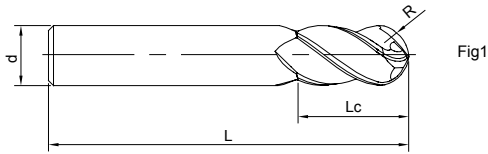

See page 97 for guidelines to icons

Ordering Code	D	R	Lc	L	d	Figure No.	Stock
ST200-B4-06012	6	3	12	50	6	1	○
ST200-B4-08014	8	4	14	60	8	1	○
ST200-B4-10018	10	5	18	75	10	1	○
ST200-B4-12022	12	6	22	80	12	1	○
ST200-B4-16026	16	8	26	90	16	1	○

●Stock ○Available upon Order

R	Tol
R 3	± 0.020

unit(mm)

Workpiece Material				
	P	M	S	
1234	5	123	123	4
Carbon Steel, Alloy steel (< 35HRC)	Alloy steel, Tool steel (< HRC48)	Stainless Steel	Heat-resistant Super Alloys	Titanium Alloys
○	○	○	○	◎

● Most Suitable ○ Suitable

Cutting Parameters ※ P456

SH160-B2

2 Flute Ballnose

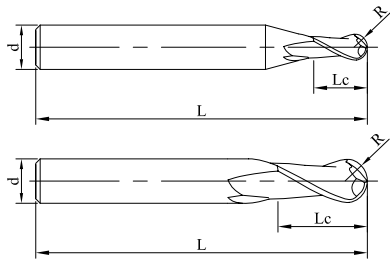

Fig1

Fig2



See page 97 for guidelines to icons

Ordering Code	D	R	Lc	L	d	Figure No.	Stock
SH160-B2-00501	0.5	0.25	1	50	4	1	●
SH160-B2-01002	1	0.5	2	50	4	1	●
SH160-B2-01503	1.5	0.75	3	50	4	1	●
SH160-B2-02004	2	1	4	50	4	1	●
SH160-B2-03006	3	1.5	6	50	4	1	●
SH160-B2-04008	4	2	8	50	4	2	●
SH160-B2-05010	5	2.5	10	50	6	1	●
SH160-B2-06012	6	3	12	50	6	2	●
SH160-B2-07014	7	3.5	14	60	8	1	●
SH160-B2-08014	8	4	14	60	8	2	●

●Stock ○Available upon Order

D	Tol
R 1.5	0 -0.01
1.5<R<3	0 -0.015
R 3	0 -0.02

unit(mm)

Workpiece Material					
P			H		
1	2	3	4	5	6
Carbon Steel, Alloy Steel (< 35HRC)	Alloy Steel (35-48HRC)	PH, Ferrite, Martensite Steel (< 35HRC)	Hardened Steel (45-55HRC)	Hardened Steel (55-60HRC)	Hardened Steel (> 60HRC)
			⊙		

⊙ Most Suitable ○ Suitable

Cutting Parameters ※ P461

SH160-B2

2 Flute Ballnose

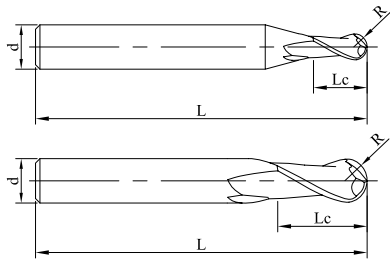

Fig1

Fig2



See page 97 for guidelines to icons

» continue

Ordering Code	D	R	Lc	L	d	Figure No.	Stock
SH160-B2-09016	9	4.5	16	75	10	1	○
SH160-B2-10018	10	5	18	75	10	2	●
SH160-B2-11020	11	5.5	20	75	12	1	○
SH160-B2-12022	12	6	22	75	12	2	●
SH160-B2-16026	16	8	26	100	16	2	●

●Stock ○Available upon Order

D	Tol
R 1.5	$\begin{matrix} 0 \\ -0.01 \end{matrix}$
1.5<R<3	$\begin{matrix} 0 \\ -0.015 \end{matrix}$
R 3	$\begin{matrix} 0 \\ -0.02 \end{matrix}$

unit(mm)

Workpiece Material

P			H		
1	2	3	4	5	6
Carbon Steel, Alloy Steel (< 35HRC)	Alloy Steel (35-48HRC)	PH, Ferrite, Martensite Steel (< 35HRC)	Hardened Steel (45-55HRC)	Hardened Steel (55-60HRC)	Hardened Steel (> 60HRC)
			⊙		

⊙ Most Suitable ○ Suitable

Cutting Parameters ※ P461

SH160-BH2

2 Flute Ballnose, with Long Shank Length

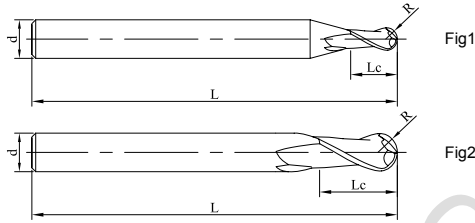

See page 97 for guidelines to icons

Ordering Code	D	R	Lc	L	d	Figure No.	Stock
SH160-BH2-04008	4	2	8	75	4	2	○
SH160-BH2-06012	6	3	12	100	6	2	●
SH160-BH2-08014	8	4	14	100	8	2	●
SH160-BH2-10018	10	5	18	100	10	2	●
SH160-BH2-12024	12	6	24	100	12	2	●

● Stock ○ Available upon Order

D	Tol
R 1.5	$\frac{0}{-0.01}$
1.5 < R < 3	$\frac{0}{-0.015}$
R 3	$\frac{0}{-0.02}$

unit(mm)

Workpiece Material					
P			H		
1	2	3	4	5	6
Carbon Steel, Alloy Steel (< 35HRC)	Alloy Steel (35-48HRC)	PH, Ferrite, Martensite Steel (< 35HRC)	Hardened Steel (45-55HRC)	Hardened Steel (55-60HRC)	Hardened Steel (> 60HRC)
			⊙		

⊙ Most Suitable ○ Suitable

Cutting Parameters ※ P461

SH160-B4

4 Flute Ballnose

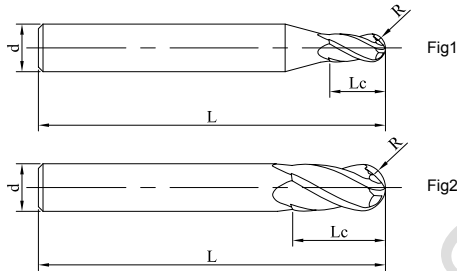

See page 97 for guidelines to icons

Ordering Code	D	R	Lc	L	d	Figure No.	Stock
SH160-B4-02004	2	1	4	50	4	1	○
SH160-B4-03006	3	1.5	6	50	4	1	●
SH160-B4-04008	4	2	8	50	4	2	○
SH160-B4-05010	5	2.5	10	50	6	1	○
SH160-B4-06012	6	3	12	50	6	2	●
SH160-B4-07014	7	3.5	14	60	8	1	○
SH160-B4-08014	8	4	14	60	8	2	●
SH160-B4-09016	9	4.5	16	75	10	1	○
SH160-B4-10018	10	5	18	75	10	2	●
SH160-B4-11020	11	5.5	20	75	12	1	○
SH160-B4-12022	12	6	22	75	12	2	○
SH160-B4-16026	16	8	26	100	16	2	○

● Stock ○ Available upon Order

D	Tol
R 1.5	$\begin{matrix} 0 \\ -0.01 \end{matrix}$
1.5 < R < 3	$\begin{matrix} 0 \\ -0.015 \end{matrix}$
R 3	$\begin{matrix} 0 \\ -0.02 \end{matrix}$

unit(mm)

Workpiece Material					
P			H		
1	2	3	4	5	6
Carbon Steel, Alloy Steel (< 35HRC)	Alloy Steel (35-48HRC)	PH, Ferrite, Martensite Steel (< 35HRC)	Hardened Steel (45-55HRC)	Hardened Steel (55-60HRC)	Hardened Steel (> 60HRC)
			⊙		

⊙ Most Suitable ○ Suitable

Cutting Parameters ※ P461

SH200-B2-H

2 Flute Ballnose

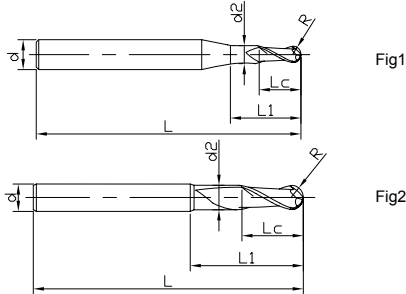

See page 97 for guidelines to icons

Ordering Code	D	R	Lc	d2	L1	L	d	Figure No.	Stock
SH200-B2-00602-H	0.6	0.3	0.6	0.57	1.5	50	4	1	○
SH200-B2-01003-H	1	0.5	1	0.95	2.5	50	4	1	●
SH200-B2-01504-H	1.5	0.75	1.5	1.45	3.75	50	4	1	●
SH200-B2-61504-H	1.5	0.75	1.5	1.45	3.75	50	6	1	○
SH200-B2-02005-H	2	1	2	1.95	5	50	4	1	●
SH200-B2-62005-H	2	1	2	1.95	5	50	6	1	○
SH200-B2-03008-H	3	1.5	3	2.9	7.5	50	4	1	●
SH200-B2-63008-H	3	1.5	3	2.9	7.5	50	6	1	●
SH200-B2-04010-H	4	2	4	3.9	10	50	4	2	●

●Stock ○Available upon Order

D	Tol
R 3	±0.005
R > 3	±0.008

unit(mm)

Workpiece Material					
P			H		
1	2	3	4	5	6
Carbon Steel, Alloy Steel (< 35HRC)	Alloy Steel (35-48HRC)	PH,Ferrite,Martensite Steel(< 35HRC)	Hardened Steel (45-55HRC)	Hardened Steel (55-60HRC)	Hardened Steel (> 60HRC)
○	◎		◎	○	

◎ Most Suitable ○ Suitable

Cutting Parameters ※ P462

SH200-B2-H

2 Flute Ballnose

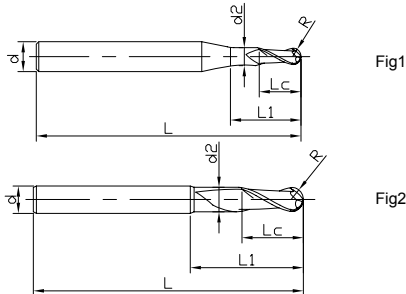

See page 97 for guidelines to icons

» continue

Ordering Code	D	R	Lc	d2	L1	L	d	Figure No.	Stock
SH200-B2-64010-H	4	2	4	3.9	10	50	6	1	○
SH200-B2-05013-H	5	2.5	5	4.9	12.5	50	6	1	●
SH200-B2-06015-H	6	3	6	5.9	15	50	6	2	●
SH200-B2-07018-H	7	3.5	7	6.9	18	60	8	1	●
SH200-B2-08020-H	8	4	8	7.9	20	60	8	2	●
SH200-B2-10025-H	10	5	10	9.9	25	75	10	2	●
SH200-B2-12030-H	12	6	12	11.9	30	75	12	2	○
SH200-B2-16016U-H	16	8	16	-	-	100	16	2	●

● Stock ○ Available upon Order

D	Tol
R 3	± 0.005
R > 3	± 0.008

unit(mm)

Workpiece Material

P			H		
1	2	3	4	5	6
Carbon Steel, Alloy Steel (< 35HRC)	Alloy Steel (35-48HRC)	PH,Ferrite,Martensite Steel(< 35HRC)	Hardened Steel (45-55HRC)	Hardened Steel (55-60HRC)	Hardened Steel (> 60HRC)
○	◎		◎	○	

◎ Most Suitable ○ Suitable

Cutting Parameters ※ P462

SH200-BH2-H

2 Flute Ballnose, with Long Shank Length

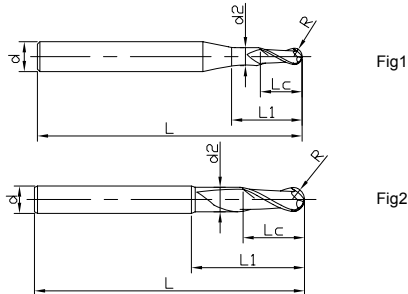

See page 97 for guidelines to icons

Ordering Code	D	R	Lc	d2	L1	L	d	Figure No.	Stock
SH200-BH2-04010E-H	4	2	4	3.9	10	60	4	2	○
SH200-BH2-04010-H	4	2	4	3.9	10	75	4	2	○
SH200-BH2-05013-H	5	2.5	5	4.9	12.5	60	6	1	●
SH200-BH2-06006E-H	6	3	6	-	-	75	6	2	●
SH200-BH2-06006F-H	6	3	6	-	-	90	6	2	○
SH200-BH2-06015-H	6	3	6	5.9	15	75	6	2	●
SH200-BH2-06015F-H	6	3	6	5.9	15	90	6	2	○
SH200-BH2-08008U-H	8	4	8	-	-	100	8	2	●
SH200-BH2-08016U-H	8	4	16	-	-	100	8	2	○
SH200-BH2-08020-H	8	4	8	7.9	20	75	8	2	●
SH200-BH2-08020F-H	8	4	8	7.9	20	90	8	2	○
SH200-BH2-12012U-H	12	6	12	-	-	150	12	2	●
SH200-BH2-12012-H	12	6	12	11.9	30	100	12	2	●
SH200-BH2-16016U-H	16	8	16	-	-	150	16	2	●

● Stock ○ Available upon Order

D	Tol
R 3	± 0.005
R > 3	± 0.008

unit(mm)

Workpiece Material					
P			H		
1 2 3 4	5	6	1	2	3 4
Carbon Steel, Alloy Steel (< 35HRC)	Alloy Steel (35-48HRC)	PH, Ferrite, Martensite Steel(< 35HRC)	Hardened Steel (45-55HRC)	Hardened Steel (55-60HRC)	Hardened Steel (> 60HRC)
○	◎		◎	○	

◎ Most Suitable ○ Suitable

Cutting Parameters ※ P462

SH200-BN2-H

2 Flute Ballnose, with Reduced Neck

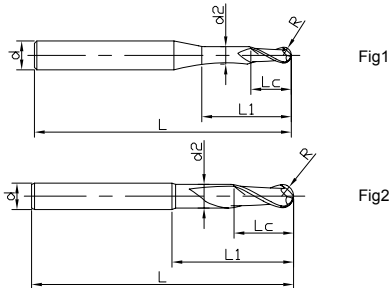

See page 97 for guidelines to icons

Ordering Code	D	R	Lc	d2	L1	L	d	Figure No.	Stock
SH200-BN2-00804-H	0.8	0.4	0.8	0.75	4	50	4	1	○
SH200-BN2-01005-H	1	0.5	1	0.95	5	50	4	1	○
SH200-BN2-01006-H	1	0.5	2	0.95	6	50	4	1	●
SH200-BN2-01506-H	1.5	0.75	1.5	1.45	6	50	4	1	○
SH200-BN2-01508-H	1.5	0.75	1.5	1.45	7.5	50	4	1	●
SH200-BN2-02010-H	2	1	2	1.95	10	50	4	1	●
SH200-BN2-02512-H	2.5	1.25	2.5	2.43	12	50	4	1	●
SH200-BN2-03015-H	3	1.5	3	2.9	15	50	4	1	○
SH200-BN2-03515-H	3.5	1.75	3.5	3.38	15	50	4	1	●
SH200-BN2-04012-H	4	2	4	3.9	12	60	4	2	○

● Stock ○ Available upon Order

D	Tol
R 3	±0.005
R > 3	±0.008

unit(mm)

Workpiece Material					
P			H		
1	2	3	4	5	6
Carbon Steel, Alloy Steel (< 35HRC)	Alloy Steel (35-48HRC)	PH,Ferrite,Martensite Steel(< 35HRC)	Hardened Steel (45-55HRC)	Hardened Steel (55-60HRC)	Hardened Steel (> 60HRC)
○	◎		◎	○	

◎ Most Suitable ○ Suitable

Cutting Parameters ※ P462

SH200-BN2-H

2 Flute Ballnose, with Reduced Neck

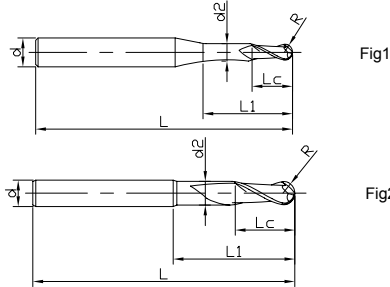

See page 97 for guidelines to icons

» continue

Ordering Code	D	R	Lc	d2	L1	L	d	Figure No.	Stock
SH200-BN2-64012-H	4	2	4	3.9	12	60	6	1	○
SH200-BN2-04016-H	4	2	4	3.9	16	60	4	2	○
SH200-BN2-64016-H	4	2	4	3.9	16	60	6	1	○
SH200-BN2-04020J-H	4	2	4	3.9	20	60	4	2	○
SH200-BN2-04020-H	4	2	4	3.9	20	75	4	2	●
SH200-BN2-06030J-H	6	3	6	5.9	30	75	6	2	●
SH200-BN2-06030-H	6	3	6	5.9	30	100	6	2	●
SH200-BN2-08040-H	8	4	8	7.9	40	100	8	2	●

●Stock ○Available upon Order

D	Tol
R 3	± 0.005
R > 3	± 0.008

unit(mm)

Workpiece Material					
P			H		
1	2	3	4	5	6
Carbon Steel, Alloy Steel (< 35HRC)	Alloy Steel (35-48HRC)	PH, Ferrite, Martensite Steel (< 35HRC)	Hardened Steel (45-55HRC)	Hardened Steel (55-60HRC)	Hardened Steel (> 60HRC)
○	◎		◎	○	

◎ Most Suitable ○ Suitable

Cutting Parameters ※ P462

SH300-B2-H

2 Flute Ballnose

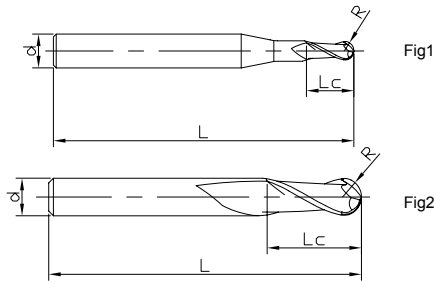

See page 97 for guidelines to icons

Ordering Code	D	R	Lc	L	d	Figure No.	Stock
SH300-B2-30601-H	0.6	0.3	0.9	50	3	1	○
SH300-B2-00601-H	0.6	0.3	0.9	50	4	1	●
SH300-B2-60601-H	0.6	0.3	0.9	50	6	1	○
SH300-B2-31002-H	1	0.5	1.5	50	3	1	○
SH300-B2-01002-H	1	0.5	1.5	50	4	1	●
SH300-B2-61002-H	1	0.5	1.5	50	6	1	○
SH300-B2-31502-H	1.5	0.75	2.3	50	3	1	○
SH300-B2-01502-H	1.5	0.75	2.3	50	4	1	●
SH300-B2-61502-H	1.5	0.75	2.3	50	6	1	○
SH300-B2-32003-H	2	1	3	50	3	1	○
SH300-B2-02003-H	2	1	3	50	4	1	●
SH300-B2-62003-H	2	1	3	50	6	1	○

●Stock ○Available upon Order

D	Tol
R 3	±0.005
R > 3	±0.007

unit(mm)

Workpiece Material					
P			H		
1	2	3	4	5	6
Carbon Steel, Alloy Steel (< 35HRC)	Alloy Steel (35-48HRC)	PH,Ferrite,Martensite Steel(< 35HRC)	Hardened Steel (45-55HRC)	Hardened Steel (55-60HRC)	Hardened Steel (> 60HRC)
	○		○	⊙	⊙

⊙ Most Suitable ○ Suitable

Cutting Parameters ※ P464

SH300-B2-H

2 Flute Ballnose

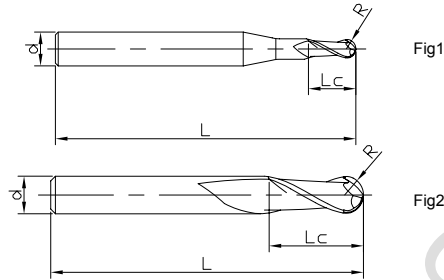

See page 97 for guidelines to icons

» continue

Ordering Code	D	R	Lc	L	d	Figure No.	Stock
SH300-B2-33005-H	3	1.5	4.5	50	3	2	○
SH300-B2-03005-H	3	1.5	4.5	50	4	1	●
SH300-B2-63005-H	3	1.5	4.5	50	6	1	○
SH300-B2-04006-H	4	2	6	50	4	2	●
SH300-B2-64006-H	4	2	6	50	6	1	○
SH300-B2-05008-H	5	2.5	7.5	50	6	1	○
SH300-B2-06009-H	6	3	9	50	6	2	●
SH300-B2-08012-H	8	4	12	60	8	2	○
SH300-B2-08012E-H	8	4	12	75	8	2	○
SH300-B2-10015-H	10	5	15	75	10	2	●
SH300-B2-12018-H	12	6	18	75	12	2	●

● Stock ○ Available upon Order

D	Tol
R 3	± 0.005
R > 3	± 0.007

unit(mm)

Workpiece Material

P			H		
1	2	3	4	5	6
Carbon Steel, Alloy Steel (< 35HRC)	Alloy Steel (35-48HRC)	PH, Ferrite, MartensiteSteel (< 35HRC)	Hardened Steel (45-55HRC)	Hardened Steel (55-60HRC)	Hardened Steel (> 60HRC)
	○		○	⊙	⊙

⊙ Most Suitable ○ Suitable

Cutting Parameters ※ P464

SH300-BH2-H

2 Flute Ballnose, with Long Shank Length

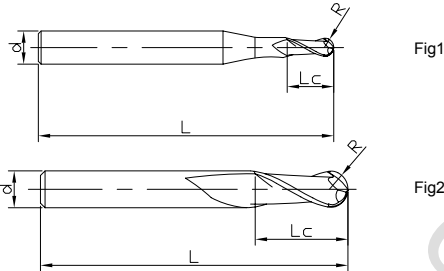

See page 97 for guidelines to icons

Ordering Code	D	R	Lc	L	d	Figure No.	Stock
SH300-BH2-30601-H	0.6	0.3	0.9	60	3	1	○
SH300-BH2-00601-H	0.6	0.3	0.9	60	4	1	○
SH300-BH2-60601-H	0.6	0.3	0.9	60	6	1	○
SH300-BH2-31002-H	1	0.5	1.5	60	3	1	○
SH300-BH2-01002-H	1	0.5	1.5	60	4	1	○
SH300-BH2-61002-H	1	0.5	1.5	60	6	1	○
SH300-BH2-31502-H	1.5	0.75	2.3	60	3	1	○
SH300-BH2-01502-H	1.5	0.75	2.3	60	4	1	○
SH300-BH2-61502-H	1.5	0.75	2.3	60	6	1	○
SH300-BH2-32003-H	2	1	3	60	3	1	○

●Stock ○Available upon Order

D	Tol
R 3	±0.005
R > 3	±0.007

unit(mm)

Workpiece Material					
P			H		
1	2	3	4	5	6
Carbon Steel, Alloy Steel (< 35HRC)	Alloy Steel (35-48HRC)	PH, Ferrite, MartensiteSteel (< 35HRC)	Hardened Steel (45-55HRC)	Hardened Steel (55-60HRC)	Hardened Steel (> 60HRC)
	○		○	◎	◎

◎ Most Suitable ○ Suitable

Cutting Parameters ※ P464

SH300-BH2-H

2 Flute Ballnose, with Long Shank Length

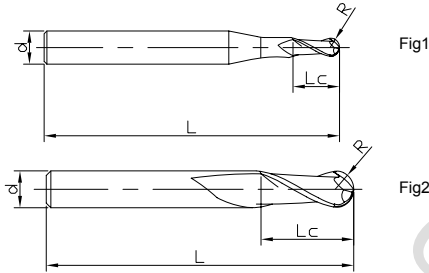

See page 97 for guidelines to icons

» continue

Ordering Code	D	R	Lc	L	d	Figure No.	Stock
SH300-BH2-02003-H	2	1	3	60	4	1	○
SH300-BH2-62003-H	2	1	3	60	6	1	○
SH300-BH2-04006-H	4	2	6	60	4	2	○
SH300-BH2-64006-H	4	2	6	60	6	1	○
SH300-BH2-05008-H	5	2.5	7.5	60	6	1	○
SH300-BH2-06009-H	6	3	9	60	6	2	○
SH300-BH2-06009E-H	6	3	9	75	6	2	●
SH300-BH2-08012-H	8	4	12	100	8	2	●
SH300-BH2-10015-H	10	5	15	100	10	2	●
SH300-BH2-12018-H	12	6	18	100	12	2	●

● Stock ○ Available upon Order

D	Tol
R 3	±0.005
R > 3	±0.007

unit(mm)

Workpiece Material					
P			H		
1	2	3	4	5	6
Carbon Steel, Alloy Steel (< 35HRC)	Alloy Steel (35-48HRC)	PH, Ferrite, MartensiteSteel (< 35HRC)	Hardened Steel (45-55HRC)	Hardened Steel (55-60HRC)	Hardened Steel (> 60HRC)
	○		○	⊙	⊙

⊙ Most Suitable ○ Suitable

Cutting Parameters ※ P464

SH300-BN2-H

2 Flute Ballnose, with Reduced Neck

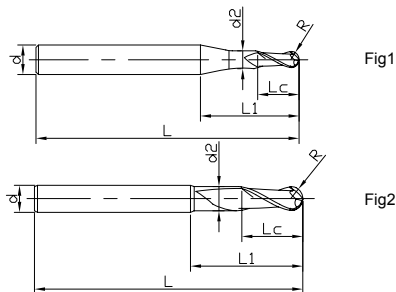

See page 97 for guidelines to icons

Ordering Code	D	R	Lc	d2	L1	L	d	Figure No.	Stock
SH300-BN2-30602-H	0.6	0.3	0.9	0.55	1.5	50	3	1	○
SH300-BN2-00602-H	0.6	0.3	0.9	0.55	1.5	50	4	1	○
SH300-BN2-60602-H	0.6	0.3	0.9	0.55	1.5	50	6	1	○
SH300-BN2-31003-H	1	0.5	1.5	0.95	2.5	50	3	1	○
SH300-BN2-01003-H	1	0.5	1.5	0.95	2.5	50	4	1	○
SH300-BN2-61003-H	1	0.5	1.5	0.95	2.5	50	6	1	○
SH300-BN2-01006-H	1	0.5	1.5	0.95	6	50	4	1	○
SH300-BN2-31504-H	1.5	0.75	2.3	1.45	3.75	50	3	1	○
SH300-BN2-01504-H	1.5	0.75	2.3	1.45	3.75	50	4	1	●
SH300-BN2-61504-H	1.5	0.75	2.3	1.45	3.75	50	6	1	○
SH300-BN2-61506-H	1.5	0.75	2.3	1.45	6	50	6	1	○

● Stock ○ Available upon Order

D	Tol
R 3	± 0.005
R > 3	± 0.007

unit(mm)

Workpiece Material

P			H		
1	2	3	4	5	6
Carbon Steel, Alloy Steel (< 35HRC)	Alloy Steel (35-48HRC)	PH, Ferrite, MartensiteSteel (< 35HRC)	Hardened Steel (45-55HRC)	Hardened Steel (55-60HRC)	Hardened Steel (> 60HRC)
	○		○	◎	◎

◎ Most Suitable ○ Suitable

Cutting Parameters ※ P464

SH300-BN2-H

2 Flute Ballnose, with Reduced Neck

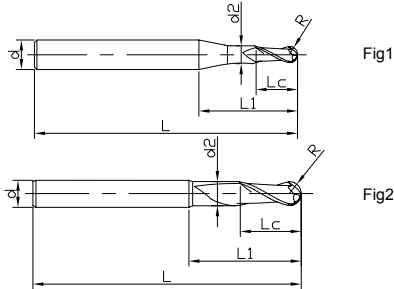

See page 97 for guidelines to icons

» continue

Ordering Code	D	R	Lc	d2	L1	L	d	Figure No.	Stock
SH300-BN2-32005-H	2	1	3	1.95	5	50	3	1	○
SH300-BN2-02005-H	2	1	3	1.95	5	50	4	1	●
SH300-BN2-62005-H	2	1	3	1.95	5	50	6	1	○
SH300-BN2-32005E-H	2	1	3	1.95	5	60	3	1	○
SH300-BN2-02005E-H	2	1	3	1.95	5	60	4	1	○
SH300-BN2-62005E-H	2	1	3	1.95	5	60	6	1	●
SH300-BN2-02006E-H	2	1	3	1.95	6	60	4	1	○
SH300-BN2-02008-H	2	1	3	1.95	8	50	4	1	○
SH300-BN2-02010E-H	2	1	3	1.95	10	60	4	1	○
SH300-BN2-33008-H	3	1.5	4.5	2.9	7.5	50	3	2	○
SH300-BN2-03006-H	3	1.5	4.5	2.9	6	50	4	1	○
SH300-BN2-03008-H	3	1.5	4.5	2.9	7.5	50	4	1	○
SH300-BN2-03015E-H	3	1.5	4.5	2.9	15	60	4	1	○

●Stock ○Available upon Order

D	Tol
R 3	±0.005
R > 3	±0.007

unit(mm)

Workpiece Material					
P			H		
1	2	3	4	5	6
Carbon Steel, Alloy Steel (< 35HRC)	Alloy Steel (35-48HRC)	PH, Ferrite, MartensiteSteel (< 35HRC)	Hardened Steel (45-55HRC)	Hardened Steel (55-60HRC)	Hardened Steel (> 60HRC)
	○		○	⊙	⊙

⊙ Most Suitable ○ Suitable

Cutting Parameters ※ P464

SH300-BN2-H

2 Flute Ballnose, with Reduced Neck

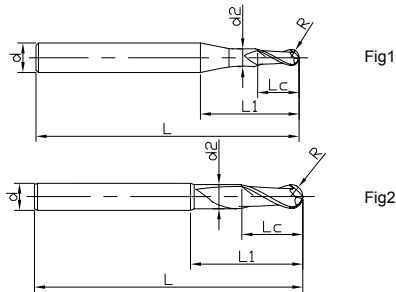

See page 97 for guidelines to icons

» continue

Ordering Code	D	R	Lc	d2	L1	L	d	Figure No.	Stock
SH300-BN2-63008-H	3	1.5	4.5	2.9	7.5	50	6	1	○
SH300-BN2-63012-H	3	1.5	4.5	2.9	12	50	6	1	○
SH300-BN2-33008E-H	3	1.5	4.5	2.9	7.5	60	3	2	○
SH300-BN2-03008E-H	3	1.5	4.5	2.9	7.5	60	4	1	●
SH300-BN2-63008E-H	3	1.5	4.5	2.9	7.5	60	6	1	○
SH300-BN2-63009E-H	3	1.5	4.5	2.9	9	60	6	1	○
SH300-BN2-63012E-H	3	1.5	4.5	2.9	12	60	6	1	○
SH300-BN2-63015E-H	3	1.5	4.5	2.9	15	60	6	1	○
SH300-BN2-04010-H	4	2	6	3.9	10	50	4	2	○
SH300-BN2-04010E-H	4	2	6	3.9	10	60	4	2	○
SH300-BN2-64010-H	4	2	6	3.9	10	50	6	1	●
SH300-BN2-64010E-H	4	2	6	3.9	10	60	6	1	○

● Stock ○ Available upon Order

D	Tol
R 3	± 0.005
R > 3	± 0.007

unit(mm)

Workpiece Material					
P			H		
1	2	3	4	5	6
Carbon Steel, Alloy Steel (< 35HRC)	Alloy Steel (35-48HRC)	PH, Ferrite, MartensiteSteel (< 35HRC)	Hardened Steel (45-55HRC)	Hardened Steel (55-60HRC)	Hardened Steel (> 60HRC)
	○		○	◎	◎

◎ Most Suitable ○ Suitable

Cutting Parameters ※ P464

SH300-BN2-H

2 Flute Ballnose, with Reduced Neck

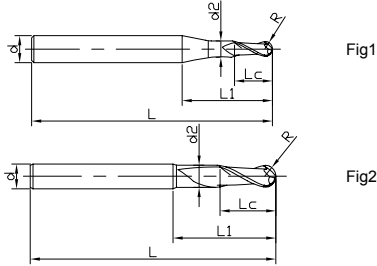

See page 97 for guidelines to icons

» continue

Ordering Code	D	R	Lc	d2	L1	L	d	Figure No.	Stock
SH300-BN2-64012E-H	4	2	6	3.9	12	60	6	1	●
SH300-BN2-64016E-H	4	2	6	3.9	16	60	6	1	○
SH300-BN2-04020F-H	4	2	6	3.9	20	75	4	2	●
SH300-BN2-05013-H	5	2.5	7.5	4.9	12.5	50	6	1	○
SH300-BN2-06015-H	6	3	9	5.9	15	50	6	2	●
SH300-BN2-06015E-H	6	3	9	5.9	15	60	6	2	○
SH300-BN2-06015F-H	6	3	9	5.9	15	75	6	2	○
SH300-BN2-06030G-H	6	3	9	5.9	30	100	6	2	●
SH300-BN2-08020-H	8	4	12	7.9	20	60	8	2	●
SH300-BN2-08020E-H	8	4	12	7.9	20	75	8	2	○
SH300-BN2-08020G-H	8	4	12	7.9	20	100	8	2	○
SH300-BN2-08040G-H	8	4	12	7.9	40	100	8	2	●

● Stock ○ Available upon Order

D	Tol
R 3	± 0.005
R > 3	± 0.007

unit(mm)

Workpiece Material					
P			H		
1	2	3	4	5	6
Carbon Steel, Alloy Steel (< 35HRC)	Alloy Steel (35-48HRC)	PH, Ferrite, MartensiteSteel (< 35HRC)	Hardened Steel (45-55HRC)	Hardened Steel (55-60HRC)	Hardened Steel (> 60HRC)
	○		○	◎	◎

◎ Most Suitable ○ Suitable

Cutting Parameters ※ P464

SH300-BN2-H

2 Flute Ballnose, with Reduced Neck

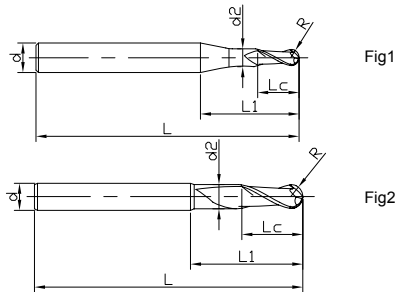

See page 97 for guidelines to icons
» continue

Ordering Code	D	R	Lc	d2	L1	L	d	Figure No.	Stock
SH300-BN2-10025-H	10	5	15	9.9	25	75	10	2	○
SH300-BN2-10025F-H	10	5	15	9.9	25	100	10	2	●
SH300-BN2-12030-H	12	6	18	11.9	30	75	12	2	○
SH300-BN2-12030F-H	12	6	18	11.9	30	100	12	2	●

● Stock ○ Available upon Order

D	Tol
R 3	± 0.005
R > 3	± 0.007

unit(mm)

Workpiece Material					
P			H		
1 2 3 4	5	6	1	2	3 4
Carbon Steel, Alloy Steel (< 35HRC)	Alloy Steel (35-48HRC)	PH, Ferrite, MartensiteSteel (< 35HRC)	Hardened Steel (45-55HRC)	Hardened Steel (55-60HRC)	Hardened Steel (> 60HRC)
	○		○	◎	◎

◎ Most Suitable ○ Suitable

Cutting Parameters ※ P464

SH300-B4-H

4 Flute Ballnose

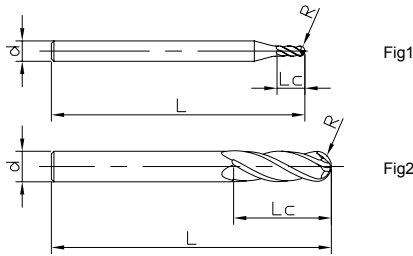

See page 97 for guidelines to icons

Ordering Code	D	R	Lc	L	d	Figure No.	Stock
SH300-B4-02003-H	2	1	3	50	4	1	○
SH300-B4-62003-H	2	1	3	50	6	1	○
SH300-B4-03005-H	3	1.5	4.5	50	4	1	○
SH300-B4-63005-H	4	2	4.5	50	6	1	○
SH300-B4-64006-H	4	2	6	50	6	1	○
SH300-B4-05008-H	5	2.5	7.5	50	6	1	○
SH300-B4-06009-H	6	3	9	50	6	2	●
SH300-B4-08012-H	8	4	12	60	8	2	●
SH300-B4-10015-H	10	5	15	75	10	2	●
SH300-B4-12018-H	12	6	18	75	12	2	○

● Stock ○ Available upon Order

D	Tol
R 3	±0.005
R > 3	±0.007

unit(mm)

Workpiece Material					
P			H		
1	2	3	4	5	6
Carbon Steel, Alloy Steel (< 35HRC)	Alloy Steel (35-48HRC)	PH, Ferrite, MartensiteSteel (< 35HRC)	Hardened Steel (45-55HRC)	Hardened Steel (55-60HRC)	Hardened Steel (> 60HRC)
	○		○	◎	◎

◎ Most Suitable ○ Suitable

Cutting Parameters ※ P465

SH300-BH4-H

4 Flute Ballnose, with Long Shank Length

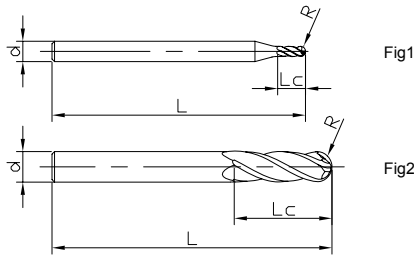

See page 97 for guidelines to icons

Ordering Code	D	R	Lc	L	d	Figure No.	Stock
SH300-BH4-02003-H	2	1	3	60	4	1	○
SH300-BH4-62003-H	2	1	3	60	6	1	○
SH300-BH4-03005-H	3	1.5	4.5	60	4	1	○
SH300-BH4-63005-H	3	1.5	4.5	60	6	1	○
SH300-BH4-64006-H	4	2	6	60	6	1	○
SH300-BH4-05008-H	5	2.5	7.5	60	6	1	○
SH300-BH4-06009-H	6	3	9	75	6	2	○
SH300-BH4-08012-H	8	4	12	75	8	2	○
SH300-BH4-10015-H	10	5	15	100	10	2	○
SH300-BH4-12018-H	12	6	18	100	12	2	○

●Stock ○Available upon Order

D	Tol
R 3	±0.005
R > 3	±0.007

unit(mm)

Workpiece Material					
P			H		
1	2	3	4	5	6
Carbon Steel, Alloy Steel (< 35HRC)	Alloy Steel (35-48HRC)	PH, Ferrite, MartensiteSteel (< 35HRC)	Hardened Steel (45-55HRC)	Hardened Steel (55-60HRC)	Hardened Steel (> 60HRC)
	○		○	◎	◎

◎ Most Suitable ○ Suitable

Cutting Parameters ※ P465

SH300-BN4-H

4 Flute Ballnose, with Reduced Neck

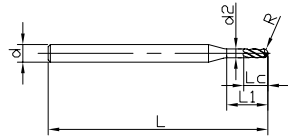

Fig1

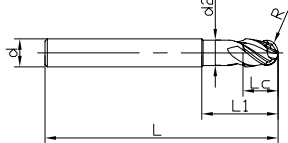

Fig2



See page 97 for guidelines to icons

Ordering Code	D	R	Lc	d2	L1	L	d	Figure No.	Stock
SH300-BN4-02006-H	2	1	3	1.9	6	50	4	1	○
SH300-BN4-62006-H	2	1	3	1.9	6	50	6	1	○
SH300-BN4-02508-H	2.5	1.25	4	2.38	7.5	50	4	1	○
SH300-BN4-62508-H	2.5	1.25	4	2.38	7.5	50	6	1	○
SH300-BN4-03009-H	3	1.5	4.5	2.9	9	60	4	1	○
SH300-BN4-63009-H	3	1.5	4.5	2.9	9	60	6	1	○
SH300-BN4-04012-H	4	2	6	3.9	12	75	4	2	○
SH300-BN4-64012-H	4	2	6	3.9	12	75	6	1	○
SH300-BN4-05015-H	5	2.5	7.5	4.7	15	75	6	1	○
SH300-BN4-06018-H	6	3	9	5.7	18	75	6	2	○
SH300-BN4-08024-H	8	4	12	7.6	24	100	8	2	○
SH300-BN4-10030-H	10	5	15	9.5	30	100	10	2	○
SH300-BN4-12036-H	12	6	18	11.5	36	120	12	2	○

●Stock ○Available upon Order

D	Tol
R 3	±0.005
R > 3	±0.007

unit(mm)

Workpiece Material					
P			H		
1	2	3	4	5	6
Carbon Steel, Alloy Steel (<35 HRC)	Alloy Steel (35-48HRC)	PH, Ferrite, Martensite Steel (< 35HRC)	Hardened Steel (45-55HRC)	Hardened Steel (55-60HRC)	Hardened Steel (> 60HRC)
	○		○	⊙	⊙

⊙ Most Suitable ○ Suitable

Cutting Parameters ※ P465

SHM100-BN2

2 Flute Ballnose, Miniature Sizes with Reduced Neck

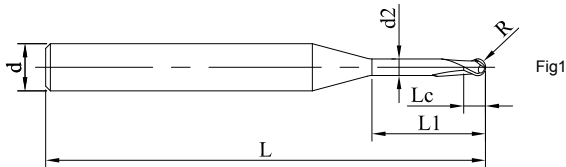

See page 97 for guidelines to icons

Ordering Code	D	R	Lc	d2	L1	L	d	Figure No.	Stock
SHM100-BN2-00401	0.4	0.2	0.3	0.35	1	50	4	1	○
SHM100-BN2-00402	0.4	0.2	0.3	0.35	2	50	4	1	○
SHM100-BN2-00403	0.4	0.2	0.3	0.35	3	50	4	1	○
SHM100-BN2-00601	0.6	0.3	0.4	0.55	1	50	4	1	○
SHM100-BN2-00602	0.6	0.3	0.4	0.55	2	50	4	1	○
SHM100-BN2-00603	0.6	0.3	0.4	0.55	3	50	4	1	○
SHM100-BN2-00802	0.8	0.4	0.6	0.75	2	50	4	1	○
SHM100-BN2-00804	0.8	0.4	0.6	0.75	4	50	4	1	○
SHM100-BN2-00806	0.8	0.4	0.6	0.75	6	50	4	1	●
SHM100-BN2-01006	1.0	0.5	0.8	0.95	6	50	4	1	○
SHM100-BN2-01008	1.0	0.5	0.8	0.95	8	50	4	1	○

● Stock ○ Available upon Order

R	Tol
0.2 R 1	0 -0.01

unit(mm)

Workpiece Material

P		M	K	H		
1 2 3 4	5	1 2 3	1 2 3	1	2	3 4
Carbon Steel, Alloy Steel (< 35HRC)	Alloy Steel (35-48HRC)	Stainless Steel	Cast Iron	Hardened Steel (45-55HRC)	Hardened Steel (55-60HRC)	Hardened Steel (> 60HRC)
				⊙		

⊙ Most Suitable ○ Suitable

Cutting Parameters ※ P469

SHM100-BN2

2 Flute Ballnose, Miniature Sizes with Reduced Neck

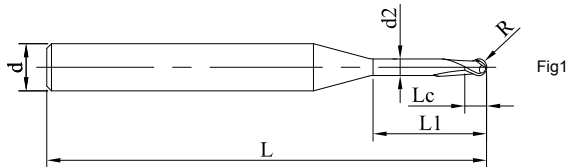

See page 97 for guidelines to icons

» continue

Ordering Code	D	R	Lc	d2	L1	L	d	Figure No.	Stock
SHM100-BN2-01010	1.0	0.5	0.8	0.95	10	50	4	1	●
SHM100-BN2-01206	1.2	0.6	1.0	1.15	6	50	4	1	○
SHM100-BN2-01208	1.2	0.6	1.0	1.15	8	50	4	1	●
SHM100-BN2-01210	1.2	0.6	1.0	1.15	10	50	4	1	●
SHM100-BN2-01508	1.5	0.75	1.4	1.44	8	50	4	1	○
SHM100-BN2-01510	1.5	0.75	1.4	1.44	10	50	4	1	●
SHM100-BN2-01512	1.5	0.75	1.4	1.44	12	50	4	1	●
SHM100-BN2-02008	2.0	1.0	1.6	1.92	8	50	4	1	○
SHM100-BN2-02010	2.0	1.0	1.6	1.92	10	50	4	1	●
SHM100-BN2-02012	2.0	1.0	1.6	1.92	12	50	4	1	●

● Stock ○ Available upon Order

R	Tol
0.2 R 1	0 -0.01

unit(mm)

Workpiece Material

P		M	K	H		
1 2 3 4	5	1 2 3	1 2 3	1	2	3 4
Carbon Steel, Alloy Steel (<35 HRC)	Alloy Steel, Tool Steel (<48HRC)	Stainless Steel	Cast Iron	Hardened Steel (45-55HRC)	Hardened Steel (55-60HRC)	Hardened Steel (> 60HRC)
				⊙		

● Most Suitable ○ Suitable

Cutting Parameters ※ P469

SD200-KDA

12 Flute, Ling Tooth

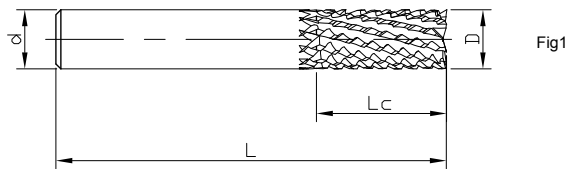

Fig1



See page 97 for guidelines to icons

Ordering Code	D	Lc	L	d	Figure No.	Stock
SD200-KDA-04010	4	10	50	4	1	○
SD200-KDA-06015	6	15	60	6	1	○
SD200-KDA-08020	8	20	60	8	1	○
SD200-KDA-10025	10	25	75	10	1	○
SD200-KDA-12030	12	30	85	12	1	○

●Stock ○Available upon Order

R	Tol
4 D 12	$\begin{matrix} 0 \\ -0.04 \end{matrix}$

unit(mm)

Workpiece Material					
P		M	N		
1234	5	123	123	4	5
Carbon Steel, Alloy Steel(<35 HRC)	Alloy Steel, Tool Steel(<48HRC)	Stainless Steel	Aluminium Alloys	Copper Alloys	CFRP, GFRP, Composite Material
					⊙

● Most Suitable ○ Suitable

Cutting Parameters ※ P451

SD200-J2

2 Flute, Herringbone End mill

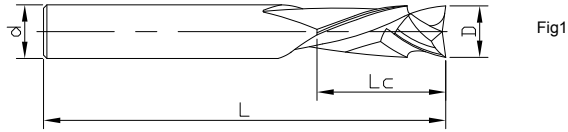

Fig1



See page 97 for guidelines to icons

Ordering Code	D	Lc	L	d	Figure No.	Stock
SD200-J2-04010	4	10	50	4	1	○
SD200-J2-06015	6	15	50	6	1	○
SD200-J2-08020	8	20	60	8	1	○
SD200-J2-10025	10	25	75	10	1	○
SD200-J2-12030	12	30	75	12	1	○

●Stock ○Available upon Order

R	Tol
4 D 12	$\begin{matrix} 0 \\ -0.04 \end{matrix}$

unit(mm)

Workpiece Material					
P		M	N		
1234	5	123	123	4	5
Carbon Steel, Alloy Steel (<35 HRC)	Alloy Steel, Tool Steel (<48HRC)	Stainless Steel	Aluminium Alloys	Copper Alloys	CFRP, GFRP, Composite Material
					⊙

● Most Suitable ○ Suitable

Cutting Parameters ※ P451



SPM200-SN2 NEW

2 Flute, Extended Neck-Square End Mill

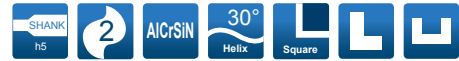
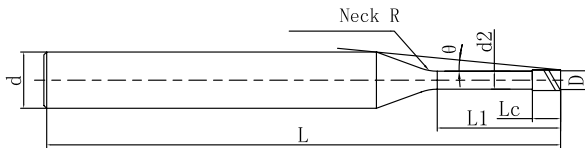

See page 97 for guidelines to icons

Ordering Code	Mill Dia. D	Under Neck Length L1	Flute Length Lc	Neck Dia. d2	Overall Length L	Shank Dia. d	Neck R	Interference Angle θ	The effective under-neck length for the various draft angles					Stock
									0.5°	1°	1.5°	2°	3°	
SPM200-SN2-0.1-0.3-V	0.1	0.3	0.15	0.08	50	4	1	14.39	0.31	0.33	0.35	0.37	0.40	●
SPM200-SN2-0.1-0.5-V		0.5						14.03	0.52	0.55	0.58	0.60	0.65	●
SPM200-SN2-0.1-1-V		1						13.22	1.05	1.09	1.13	1.18	1.27	●
SPM200-SN2-0.2-0.5-V	0.2	0.5	0.3	0.17	50	4	1	14.03	0.52	0.54	0.57	0.59	0.64	●
SPM200-SN2-0.2-1-V		1						13.20	1.04	1.08	1.12	1.16	1.26	●
SPM200-SN2-0.2-1.5-V		1.5						12.45	1.56	1.62	1.67	1.74	1.88	●
SPM200-SN2-0.2-2-V		2						11.79	2.08	2.15	2.23	2.31	2.50	●
SPM200-SN2-0.2-3-V		3						10.65	3.11	3.22	3.34	3.46	3.74	●
SPM200-SN2-0.3-1-V	0.3	1	0.45	0.27	50	4	2	13.06	1.06	1.12	1.18	1.23	1.33	●
SPM200-SN2-0.3-1.5-V		1.5						12.31	1.59	1.67	1.74	1.81	1.95	●
SPM200-SN2-0.3-2-V		2						11.65	2.12	2.21	2.29	2.38	2.57	●
SPM200-SN2-0.3-2.5-V		2.5						11.05	2.64	2.75	2.85	2.96	3.20	●
SPM200-SN2-0.3-3-V		3						10.51	3.16	3.28	3.40	3.53	3.82	●
SPM200-SN2-0.4-1-V	0.4	1	0.6	0.37	50	4	2	13.01	1.06	1.12	1.18	1.23	1.33	●
SPM200-SN2-0.4-1.5-V		1.5						12.25	1.59	1.67	1.74	1.81	1.95	●
SPM200-SN2-0.4-2-V		2						11.57	2.12	2.21	2.29	2.38	2.57	●
SPM200-SN2-0.4-2.5-V		2.5						10.97	2.64	2.75	2.85	2.96	3.20	●
SPM200-SN2-0.4-3-V		3						10.42	3.16	3.28	3.40	3.53	3.82	●
SPM200-SN2-0.4-3.5-V		3.5						9.92	3.68	3.82	3.96	4.11	4.44	●
SPM200-SN2-0.4-4-V		4						9.47	4.20	4.35	4.51	4.68	5.06	●
SPM200-SN2-0.4-5-V		5						8.68	5.24	5.42	5.62	5.83	6.30	●
SPM200-SN2-0.4-6-V		6						8.01	6.27	6.49	6.73	6.98	7.55	●
SPM200-SN2-0.4-8-V		8						6.94	8.34	8.63	8.94	9.28	10.03	●
SPM200-SN2-0.4-10-V	10	6.12	10.41	10.77	11.16	11.58	12.52	●						

● Stock ○ Available upon Order

D	Tol.
0.1≤D≤0.5	0 -0.007
0.6≤D≤0.9	0 -0.01
1.0≤D≤6.0	0 -0.015

(mm)

Cutting Parameters ※ P470

SPM200-SN2 NEW

2 Flute, Extended Neck-Square End Mill

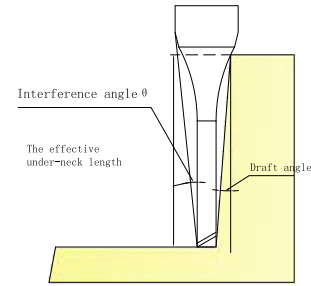
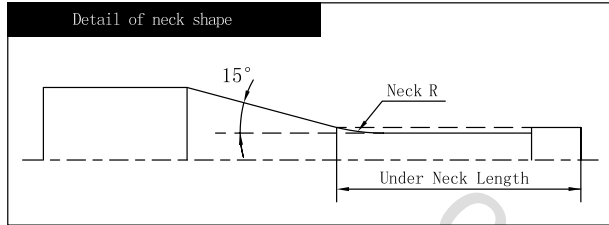

See page 97 for guidelines to icons

» Continue

Ordering Code	Mill Dia. D	Under Neck Length L1	Flute Length Lc	Neck Dia. d2	Overall Length L	Shank Dia. d	Neck R	Interference Angle θ	The effective under-neck length for the various draft angles					Stock
									0.5°	1°	1.5°	2°	3°	
SPM200-SN2-0.5-1-V	0.5	1	0.75	0.47	50	4	2	12.96	1.06	1.12	1.18	1.23	1.33	●
SPM200-SN2-0.5-1.5-V		1.5						12.19	1.59	1.67	1.74	1.81	1.95	●
SPM200-SN2-0.5-2-V		2						11.50	2.12	2.21	2.29	2.38	2.57	●
SPM200-SN2-0.5-2.5-V		2.5						10.88	2.64	2.75	2.85	2.96	3.20	●
SPM200-SN2-0.5-3-V		3						10.33	3.16	3.28	3.40	3.53	3.82	●
SPM200-SN2-0.5-4-V		4						9.37	4.20	4.35	4.51	4.68	5.06	●
SPM200-SN2-0.5-5-V		5						8.58	5.24	5.42	5.62	5.83	6.30	●
SPM200-SN2-0.5-6-V		6						7.91	6.27	6.49	6.73	6.98	7.55	●
SPM200-SN2-0.5-8-V		8						6.84	8.34	8.63	8.94	9.28	10.03	●
SPM200-SN2-0.5-10-V		10						6.02	10.41	10.77	11.16	11.58	12.52	●
SPM200-SN2-0.6-2-V	0.6	2	0.9	0.57	50	4	4	11.21	2.17	2.31	2.44	2.56	2.78	●
SPM200-SN2-0.6-3-V		3						10.07	3.24	3.42	3.58	3.72	4.02	●
SPM200-SN2-0.6-4-V		4						9.13	4.30	4.51	4.69	4.87	5.26	●
SPM200-SN2-0.6-5-V		5						8.36	5.35	5.59	5.80	6.02	6.50	●
SPM200-SN2-0.6-6-V		6						7.70	6.40	6.67	6.91	7.17	7.75	●
SPM200-SN2-0.6-7-V		7						7.14	7.44	7.74	8.02	8.32	8.99	●
SPM200-SN2-0.6-8-V		8						6.66	8.49	8.81	9.12	9.47	10.23	●
SPM200-SN2-0.6-9-V		9						6.23	9.53	9.88	10.23	10.62	11.48	●
SPM200-SN2-0.6-10-V		10						5.86	10.57	10.94	11.34	11.77	12.72	●
SPM200-SN2-0.7-2-V		0.7						2	1.05	0.67	50	4	4	11.13
SPM200-SN2-0.7-4-V	4		9.02	4.30	4.51	4.69	4.87	5.26						●
SPM200-SN2-0.7-6-V	6		7.59	6.40	6.67	6.91	7.17	7.75						●
SPM200-SN2-0.7-8-V	8		6.54	8.49	8.81	9.12	9.47	10.23						●
SPM200-SN2-0.7-10-V	10		5.75	10.57	10.94	11.34	11.77	12.72						●

● Stock ○ Available upon Order

D	Tol.
0.1 ≤ D ≤ 0.5	0 -0.007
0.6 ≤ D ≤ 0.9	0 -0.01
1.0 ≤ D ≤ 6.0	0 -0.015

(mm)

Cutting Parameters ※ P470

SPM200-SN2 NEW

2 Flute, Extended Neck-Square End Mill

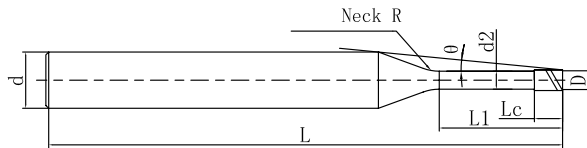

See page 97 for guidelines to icons

» Continue

Ordering Code	Mill Dia. D	Under Neck Length L1	Flute Length Lc	Neck Dia. d2	Overall Length L	Shank Dia. d	Neck R	Interference Angle θ	The effective under-neck length for the various draft angles					Stock
									0.5°	1°	1.5°	2°	3°	
SPM200-SN2-0.8-4-V	0.8	4	1.2	0.76	50	4	4	8.94	4.27	4.48	4.65	4.83	5.22	●
SPM200-SN2-0.8-6-V		6			7.49			6.37	6.63	6.87	7.13	7.70	●	
SPM200-SN2-0.8-8-V		8			6.45			8.46	8.77	9.09	9.43	10.19	●	
SPM200-SN2-0.8-10-V		10			5.65			10.54	10.91	11.30	11.73	12.68	●	
SPM200-SN2-0.8-12-V		12			5.04			12.61	13.05	13.52	14.03	15.16	●	
SPM200-SN2-0.9-6-V	0.9	6	1.35	0.86	50	4	4	7.37	6.37	6.63	6.87	7.13	7.70	●
SPM200-SN2-0.9-8-V		8			6.33			8.46	8.77	9.09	9.43	10.19	●	
SPM200-SN2-0.9-10-V		10			5.54			10.54	10.91	11.30	11.73	12.68	●	
SPM200-SN2-0.9-12-V		12			4.93			12.61	13.05	13.52	14.03	15.16	●	
SPM200-SN2-1-2-V	1	2	1.5	0.96	50	4	4	10.89	2.15	2.29	2.41	2.52	2.73	●
SPM200-SN2-1-3-V		3			9.68			3.21	3.39	3.54	3.68	3.98	●	
SPM200-SN2-1-4-V		4			8.71			4.27	4.48	4.65	4.83	5.22	●	
SPM200-SN2-1-5-V		5			7.91			5.32	5.56	5.76	5.98	6.46	●	
SPM200-SN2-1-6-V		6			7.25			6.37	6.63	6.87	7.13	7.70	●	
SPM200-SN2-1-7-V		7			6.69			7.41	7.7	7.98	8.28	8.95	●	
SPM200-SN2-1-8-V		8			6.21			8.46	8.77	9.09	9.43	10.19	●	
SPM200-SN2-1-9-V		9			5.79			9.50	9.84	10.19	10.58	11.43	●	
SPM200-SN2-1-10-V		10			5.43			10.54	10.91	11.30	11.73	12.68	●	
SPM200-SN2-1-12-V		12			4.82			12.61	13.05	13.52	14.03	15.16	●	
SPM200-SN2-1-14-V		14			4.34			14.67	15.19	15.73	16.32	17.65	●	
SPM200-SN2-1-16-V		16			3.94			16.74	17.33	17.95	18.62	20.14	●	
SPM200-SN2-1-20-V		20			3.33			20.88	21.6	22.38	23.22	25.11	●	
SPM200-SN2-1-25-V		25			2.79			26.05	26.95	27.93	28.97	-	●	
SPM200-SN2-1.2-6-V		1.2			6			1.8	1.15	50	4	4	7.01	6.35

● Stock ○ Available upon Order

D	Tol.
0.1≤D≤0.5	0 -0.007
0.6≤D≤0.9	0 -0.01
1.0≤D≤6.0	0 -0.015

(mm)

Cutting Parameters ※ P470

SPM200-SN2 NEW

2 Flute, Extended Neck-Square End Mill

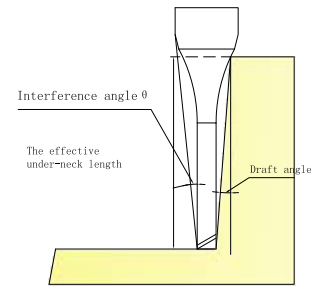
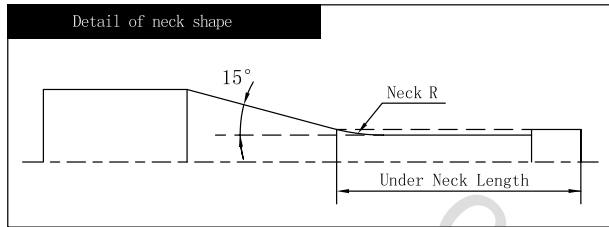

See page 97 for guidelines to icons

» Continue

Ordering Code	Mill Dia. D	Under Neck Length L1	Flute Length Lc	Neck Dia. d2	Overall Length L	Shank Dia. d	Neck R	Interference Angle θ	The effective under-neck length for the various draft angles					Stock					
									0.5°	1°	1.5°	2°	3°						
SPM200-SN2-1.2-8-V	1.2	8	1.8	1.15	50	4	4	5.97	8.43	8.74	9.05	9.39	10.16	●					
SPM200-SN2-1.2-10-V		10			5.20			10.51	10.88	11.27	11.69	12.64	●						
SPM200-SN2-1.2-12-V		12			4.61			12.58	13.02	13.49	13.99	15.13	●						
SPM200-SN2-1.2-16-V		16			3.75			16.71	17.3	17.92	18.59	20.10	●						
SPM200-SN2-1.4-6-V	1.4	6	2.1	1.34	50	4	4	6.74	6.33	6.57	6.81	7.07	7.64	●					
SPM200-SN2-1.4-12-V		12			4.38			12.55	12.99	13.46	13.97	15.10	●						
SPM200-SN2-1.5-4-V	1.5	4	2.25	1.44	50	4	4	8.08	4.24	4.43	4.59	4.77	5.15	●					
SPM200-SN2-1.5-6-V		6			6.60			6.33	6.57	6.81	7.07	7.64	●						
SPM200-SN2-1.5-8-V		8			5.58			8.41	8.71	9.03	9.37	10.13	●						
SPM200-SN2-1.5-10-V		10			4.83			10.48	10.85	11.24	11.67	12.61	●						
SPM200-SN2-1.5-12-V		12			4.26			12.55	12.99	13.46	13.97	15.10	●						
SPM200-SN2-1.5-14-V		14			3.81			14.62	15.13	15.68	16.26	17.58	●						
SPM200-SN2-1.5-16-V		16			3.44			16.69	17.27	17.89	18.56	20.07	●						
SPM200-SN2-1.5-18-V		18			3.14			18.76	19.41	20.11	20.86	22.56	●						
SPM200-SN2-1.5-20-V		20			2.89			20.82	21.55	22.33	23.16	-	●						
SPM200-SN2-1.5-25-V		25			2.41			25.99	26.9	27.87	28.91	-	●						
SPM200-SN2-1.5-30-V		30			2.06			31.16	32.25	33.41	34.66	-	●						
SPM200-SN2-1.5-35-V		35			1.80			36.33	37.59	38.95	-	-	●						
SPM200-SN2-1.5-40-V		40			1.60			41.50	42.94	44.49	-	-	●						
SPM200-SN2-1.6-6-V		1.6			6			2.4	1.54	50	4	4	6.45	6.33	6.57	6.81	7.07	7.64	●
SPM200-SN2-1.6-8-V					8					5.43			8.41	8.71	9.03	9.37	10.13	●	
SPM200-SN2-1.8-6-V		1.8			6			2.7	1.73	50	4	4	6.14	6.31	6.55	6.79	7.04	7.61	●
SPM200-SN2-1.8-8-V	8		5.14	8.39	8.69	9.00	9.34			10.10			●						
SPM200-SN2-2-4-V	2	4	3	1.92	50	4	4	7.27	4.21	4.39	4.55	4.72	5.11	●					

● Stock ○ Available upon Order

D	Tol.
0.1 ≤ D ≤ 0.5	0 -0.007
0.6 ≤ D ≤ 0.9	0 -0.01
1.0 ≤ D ≤ 6.0	0 -0.015

(mm)

Cutting Parameters ※ P470

SPM200-SN2 NEW

2 Flute, Extended Neck-Square End Mill

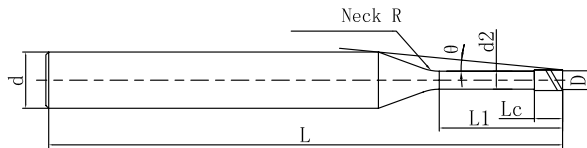

See page 97 for guidelines to icons

» Continue

Ordering Code	Mill Dia. D	Under Neck Length L1	Flute Length Lc	Neck Dia. d2	Overall Length L	Shank Dia. d	Neck R	Interference Angle θ	The effective under-neck length for the various draft angles					Stock
									0.5°	1°	1.5°	2°	3°	
SPM200-SN2-2-6-V	2	6	3	1.92	50	4	4	5.81	6.30	6.53	6.77	7.02	7.59	●
SPM200-SN2-2-8-V		8			4.83			8.38	8.67	8.99	9.32	10.08	●	
SPM200-SN2-2-10-V		10			4.14			10.45	10.81	11.20	11.62	12.57	●	
SPM200-SN2-2-12-V		12			3.62			12.51	12.95	13.42	13.92	15.05	●	
SPM200-SN2-2-14-V		14			3.21			14.58	15.09	15.64	16.22	17.54	●	
SPM200-SN2-2-16-V		16			2.89			16.65	17.23	17.85	18.52	-	●	
SPM200-SN2-2-18-V		18			2.63			18.72	19.37	20.07	20.82	-	●	
SPM200-SN2-2-20-V		20			2.41			20.78	21.51	22.28	23.12	-	●	
SPM200-SN2-2-25-V		25			1.99			25.95	26.86	27.83	-	-	●	
SPM200-SN2-2-30-V		30			1.70			31.12	32.2	33.37	-	-	●	
SPM200-SN2-2-35-V		35			1.48			36.29	37.55	-	-	-	●	
SPM200-SN2-2-40-V		40			1.31			41.46	42.9	-	-	-	●	
SPM200-SN2-2-50-V		50			1.07			51.79	53.6	-	-	-	●	
SPM200-SN2-2.5-8-V	2.5	8	3.75	2.4	50	4	4	3.95	8.35	8.64	8.95	9.29	10.04	●
SPM200-SN2-2.5-12-V		12			2.89			12.48	12.92	13.39	13.89	-	●	
SPM200-SN2-2.5-16-V		16			2.28			16.62	17.2	17.82	18.49	-	●	
SPM200-SN2-2.5-20-V		20			1.88			20.75	21.48	22.25	-	-	●	
SPM200-SN2-2.5-30-V		30			1.31			31.09	32.17	-	-	-	●	
SPM200-SN2-2.5-40-V		40			1.01			41.43	42.87	-	-	-	●	
SPM200-SN2-2.5-50-V	50	0.82	51.76	-	-	-	-	●						
SPM200-SN2-3-8-V	3	8	4.5	2.88	55	6	4	6.27	8.33	8.62	8.93	9.26	10.02	●
SPM200-SN2-3-12-V		12			4.86			12.46	12.9	13.36	13.86	14.99	●	
SPM200-SN2-3-16-V		16			3.97			16.60	17.17	17.79	18.46	19.96	●	
SPM200-SN2-3-20-V		20			3.35			20.73	21.45	22.23	23.06	24.93	●	

● Stock ○ Available upon Order

D	Tol.
0.1 ≤ D ≤ 0.5	0 -0.007
0.6 ≤ D ≤ 0.9	0 -0.01
1.0 ≤ D ≤ 6.0	0 -0.015

(mm)

Cutting Parameters * P470

SPM200-SN2 NEW

2 Flute, Extended Neck-Square End Mill

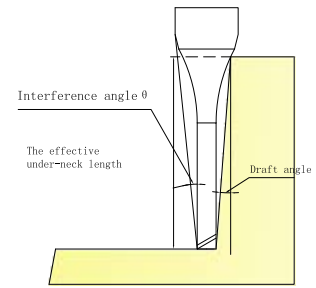
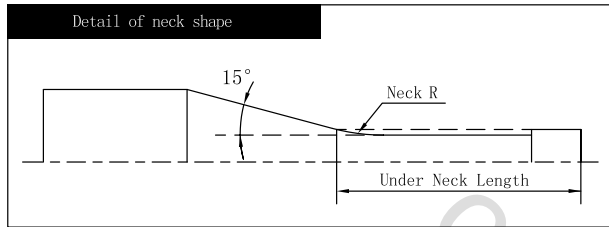

See page 97 for guidelines to icons

» Continue

Ordering Code	Mill Dia. D	Under Neck Length L1	Flute Length Lc	Neck Dia. d2	Overall Length L	Shank Dia. d	Neck R	Interference Angle θ	The effective under-neck length for the various draft angles					Stock
									0.5°	1°	1.5°	2°	3°	
SPM200-SN2-3-25-V	3	25	4.5	2.88	70	6	4	2.81	25.90	26.8	27.77	28.81	-	•
SPM200-SN2-3-30-V		30			75			2.41	31.07	32.15	33.31	34.56	-	•
SPM200-SN2-3-40-V		40			90			1.89	41.40	42.85	44.39	-	-	•
SPM200-SN2-3-50-V		50			100			1.55	51.74	53.54	55.48	-	-	•
SPM200-SN2-4-12-V	4	12	6	3.86	60	6	4	3.63	12.44	12.88	13.34	13.84	14.97	•
SPM200-SN2-4-16-V		16			60			2.90	16.58	17.16	17.78	18.44	-	•
SPM200-SN2-4-20-V		20			70			2.41	20.71	21.43	22.21	23.04	-	•
SPM200-SN2-4-25-V		25			70			2.00	25.88	26.78	27.75	-	-	•
SPM200-SN2-4-30-V		30			80			1.70	31.05	32.13	33.29	-	-	•
SPM200-SN2-4-35-V		35			80			1.48	36.22	37.48	-	-	-	•
SPM200-SN2-4-40-V		40			90			1.31	41.39	42.83	-	-	-	•
SPM200-SN2-4-50-V		50			100			1.07	51.72	53.52	-	-	-	•
SPM200-SN2-5-20-V	5	20	7.5	4.85	70	6	4	1.31	20.71	21.43	-	-	-	•
SPM200-SN2-5-25-V		25			70			1.07	25.87	26.78	-	-	-	•
SPM200-SN2-5-30-V		30			80			0.90	31.04	-	-	-	-	•
SPM200-SN2-5-40-V		40			90			0.69	41.38	-	-	-	-	•
SPM200-SN2-5-50-V		50			100			0.56	51.72	-	-	-	-	•
SPM200-SN2-6-20-V	6	20	9	5.85	70	6	-	-	-	-	-	-	-	•
SPM200-SN2-6-30-V		30			80			-	-	-	-	-	-	•
SPM200-SN2-6-40-V		40			90			-	-	-	-	-	-	•
SPM200-SN2-6-50-V		50			100			-	-	-	-	-	-	•

• Stock ◦ Available upon Order

D	Tol.
0.1 ≤ D ≤ 0.5	0 -0.007
0.6 ≤ D ≤ 0.9	0 -0.01
1.0 ≤ D ≤ 6.0	0 -0.015

(mm)

Cutting Parameters ※ P470

SPM200-RN2 NEW

2 Flute, Extended Neck-Corner Radius End Mill

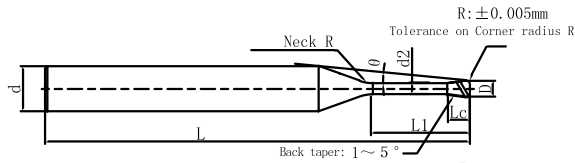

Φ4 or higher does not have backdraft shape



See page 97 for guidelines to icons

Ordering Code	Mill Dia. D	Corner Radius R	Under Neck Length L1	Flute Length Lc	Neck Dia. d2	Overall Length L	Shank Dia. d	Neck R	Interference Angle θ	The effective under-neck length for the various draft angles					Stock
										0.5°	1°	1.5°	2°	3°	
SPM200-RN2-0.2-0.5-0.02-V	0.2	0.02	0.5	0.16	0.17	50	4	1	14.07	0.52	0.54	0.56	0.58	0.63	●
SPM200-RN2-0.2-1-0.02-V			1						13.23	1.04	1.08	1.12	1.16	1.25	●
SPM200-RN2-0.2-2-0.02-V			2						11.82	2.08	2.15	2.23	2.31	2.50	●
SPM200-RN2-0.2-0.5-0.05-V		0.05	0.5						0.5	0.56	0.58	0.62	●		
SPM200-RN2-0.2-1-0.05-V			1						13.28	1.04	1.08	1.11	1.15	1.24	●
SPM200-RN2-0.2-1.5-0.05-V			1.5						12.53	1.56	1.61	1.67	1.73	1.87	●
SPM200-RN2-0.2-2-0.05-V			2						11.85	2.08	2.15	2.22	2.30	2.49	●
SPM200-RN2-0.3-1-0.02-V			0.3						0.02	1	0.24	0.27	50	4	2
SPM200-RN2-0.3-2-0.02-V	2	11.67		2.11	2.21	2.29	2.38	2.57		●					
SPM200-RN2-0.3-3-0.02-V	3	10.53		3.16	3.28	3.40	3.53	3.81		●					
SPM200-RN2-0.3-1-0.05-V	0.05	1		13.14	1.06	1.12	1.17	1.22	1.32	●					
SPM200-RN2-0.3-1.5-0.05-V		1.5		12.38	1.59	1.66	1.73	1.80	1.94	●					
SPM200-RN2-0.3-2-0.05-V		2		11.71	2.11	2.21	2.29	2.37	2.56	●					
SPM200-RN2-0.3-2.5-0.05-V		2.5		11.11	2.64	2.75	2.84	2.95	3.18	●					
SPM200-RN2-0.3-3-0.05-V		3		10.56	3.16	3.28	3.40	3.52	3.81	●					
SPM200-RN2-0.4-1-0.02-V	0.4	0.02	1	0.32	0.37	50	4	2	13.04	1.06	1.12	1.17	1.23	1.33	●
SPM200-RN2-0.4-2-0.02-V			2						11.60	2.11	2.21	2.29	2.38	2.57	●
SPM200-RN2-0.4-3-0.02-V			3						10.44	3.16	3.28	3.40	3.53	3.81	●
SPM200-RN2-0.4-4-0.02-V			4						9.49	4.20	4.35	4.51	4.68	5.06	●
SPM200-RN2-0.4-1-0.05-V		0.05	1						13.09	1.06	1.12	1.17	1.22	1.32	●
SPM200-RN2-0.4-1.5-0.05-V			1.5						12.32	1.59	1.66	1.73	1.80	1.94	●
SPM200-RN2-0.4-2-0.05-V			2						11.64	2.11	2.21	2.29	2.37	2.56	●
SPM200-RN2-0.4-2.5-0.05-V			2.5						11.03	2.64	2.75	2.84	2.95	3.18	●
SPM200-RN2-0.4-3-0.05-V			3						10.47	3.16	3.28	3.40	3.52	3.81	●
SPM200-RN2-0.4-4-0.05-V			4						9.49	4.20	4.35	4.51	4.68	5.06	●

● Stock ○ Available upon Order

R	Tol.
R	±0.005

(mm)

Cutting Parameters ※ P480

SPM200-RN2 NEW

2 Flute, Extended Neck-Corner Radius End Mill

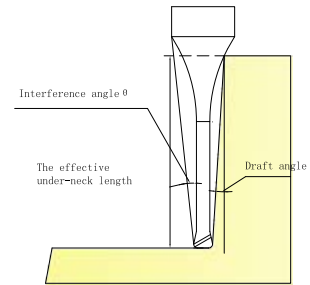
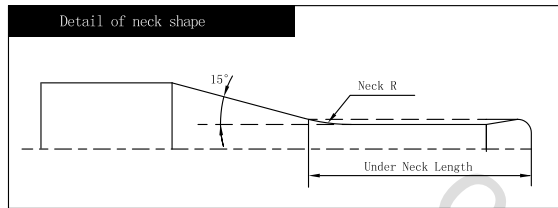

See page 97 for guidelines to icons

» Continue

Ordering Code	Mill Dia. D	Corner Radius R	Under Neck Length L1	Flute Length Lc	Neck Dia. d2	Overall Length L	Shank Dia. d	Neck R	Interference Angle θ	The effective under-neck length for the various draft angles					Stock
										0.5°	1°	1.5°	2°	3°	
SPM200-RN2-0.4-3.5-0.05-V	0.4	0.05	3.5	0.32	0.37	50	4	2	9.97	3.68	3.82	3.95	4.10	4.43	●
SPM200-RN2-0.4-4-0.05-V			4						9.52	4.20	4.35	4.51	4.67	5.05	●
SPM200-RN2-0.4-1-0.1-V		0.1	1						13.17	1.06	1.11	1.16	1.21	1.31	●
SPM200-RN2-0.4-2-0.1-V			2						11.70	2.11	2.20	2.28	2.37	2.55	●
SPM200-RN2-0.4-3-0.1-V			3						10.53	3.16	3.28	3.39	3.52	3.79	●
SPM200-RN2-0.4-4-0.1-V			4						9.56	4.20	4.35	4.50	4.67	5.04	●
SPM200-RN2-0.5-1-0.02-V	0.5	0.02	1	0.4	0.47	50	4	2	13.00	1.06	1.12	1.17	1.23	1.33	●
SPM200-RN2-0.5-2-0.02-V			2						11.53	2.11	2.21	2.29	2.38	2.57	●
SPM200-RN2-0.5-3-0.02-V			3						10.35	3.16	3.28	3.40	3.53	3.81	●
SPM200-RN2-0.5-4-0.02-V			4						9.39	4.20	4.35	4.51	4.68	5.06	●
SPM200-RN2-0.5-6-0.02-V			6						7.92	6.27	6.49	6.73	6.98	7.54	●
SPM200-RN2-0.5-1-0.05-V			0.05						1	13.05	1.06	1.12	1.17	1.22	1.32
SPM200-RN2-0.5-2-0.05-V		2							11.56	2.11	2.21	2.29	2.37	2.56	●
SPM200-RN2-0.5-3-0.05-V		3							10.38	3.16	3.28	3.40	3.52	3.81	●
SPM200-RN2-0.5-4-0.05-V		4							9.42	4.20	4.35	4.51	4.67	5.05	●
SPM200-RN2-0.5-5-0.05-V		5							8.62	5.24	5.42	5.61	5.82	6.29	●
SPM200-RN2-0.5-6-0.05-V		6							7.94	6.27	6.49	6.72	6.97	7.53	●
SPM200-RN2-0.5-1-0.1-V		0.1	1						13.13	1.06	1.11	1.16	1.21	1.31	●
SPM200-RN2-0.5-2-0.1-V			2						11.63	2.11	2.20	2.28	2.37	2.55	●
SPM200-RN2-0.5-3-0.1-V			3						10.44	3.16	3.28	3.39	3.52	3.79	●
SPM200-RN2-0.5-4-0.1-V			4						9.46	4.20	4.35	4.50	4.67	5.04	●
SPM200-RN2-0.5-5-0.1-V			5						8.65	5.24	5.42	5.61	5.82	6.28	●
SPM200-RN2-0.5-6-0.1-V			6						7.97	6.27	6.49	6.72	6.97	7.52	●
SPM200-RN2-0.6-2-0.02-V		0.6	0.02						2	0.48	0.57	50	4	4	11.24

● Stock ○ Available upon Order

R	Tol.
R	±0.005

(mm)

Cutting Parameters ※ P480

SPM200-RN2 NEW

2 Flute, Extended Neck-Corner Radius End Mill

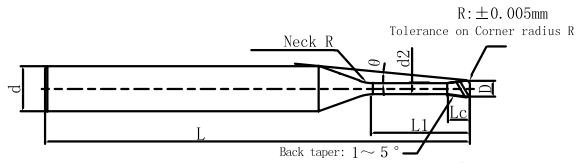

Φ4 or higher does not have backdraft shape



See page 97 for guidelines to icons

» Continue

Ordering Code	Mill Dia. D	Corner Radius R	Under Neck Length L1	Flute Length Lc	Neck Dia. d2	Overall Length L	Shank Dia. d	Neck R	Interference Angle θ	The effective under-neck length for the various draft angles					Stock
										0.5°	1°	1.5°	2°	3°	
SPM200-RN2-0.6-4-0.02-V	0.6	0.02	4	0.48	0.57	50	4	4	9.15	4.29	4.51	4.69	4.86	5.26	●
SPM200-RN2-0.6-6-0.02-V			6						7.71	6.40	6.66	6.90	7.16	7.74	●
SPM200-RN2-0.6-2-0.05-V		0.05	2						11.27	2.17	2.31	2.43	2.55	2.76	●
SPM200-RN2-0.6-4-0.05-V			4						9.18	4.29	4.51	4.68	4.86	5.25	●
SPM200-RN2-0.6-6-0.05-V		6	7.73						6.40	6.66	6.90	7.16	7.74	●	
SPM200-RN2-0.6-8-0.05-V		8	6.68						8.49	8.80	9.12	9.46	10.22	●	
SPM200-RN2-0.6-10-0.05-V		10	5.88						10.57	10.94	11.33	11.76	12.71	●	
SPM200-RN2-0.6-2-0.1-V		0.1	2						11.34	2.16	2.30	2.43	2.54	2.75	●
SPM200-RN2-0.6-4-0.1-V			4						9.22	4.29	4.50	4.68	4.85	5.24	●
SPM200-RN2-0.6-6-0.1-V			6						7.76	6.39	6.66	6.90	7.15	7.72	●
SPM200-RN2-0.6-8-0.1-V			8						6.70	8.48	8.80	9.11	9.45	10.21	●
SPM200-RN2-0.6-10-0.1-V			10						5.89	10.57	10.94	11.33	11.75	12.70	●
SPM200-RN2-0.7-4-0.05-V	0.7		0.05	4	0.56	0.67	50	4	4	9.07	4.29	4.51	4.68	4.86	5.25
SPM200-RN2-0.7-6-0.05-V		6		7.62						6.40	6.66	6.90	7.16	7.74	●
SPM200-RN2-0.7-4-0.1-V		0.1	4	9.11						4.29	4.50	4.68	4.85	5.24	●
SPM200-RN2-0.7-6-0.1-V			6	7.65						6.39	6.66	6.90	7.15	7.72	●
SPM200-RN2-0.8-4-0.02-V	0.8	0.02	4	0.64	0.76	50	4	4	8.96	4.27	4.47	4.65	4.82	5.21	●
SPM200-RN2-0.8-6-0.02-V			6						7.51	6.37	6.63	6.87	7.12	7.70	●
SPM200-RN2-0.8-4-0.05-V		0.05	4						8.99	4.27	4.47	4.65	4.82	5.21	●
SPM200-RN2-0.8-6-0.05-V			6						7.52	6.37	6.63	6.86	7.12	7.69	●
SPM200-RN2-0.8-8-0.05-V		8	6.47						8.45	8.76	9.08	9.42	10.18	●	
SPM200-RN2-0.8-12-0.05-V		12	5.05						12.61	13.04	13.51	14.02	15.15	●	
SPM200-RN2-0.8-4-0.1-V		0.1	4						9.03	4.26	4.47	4.64	4.81	5.19	●
SPM200-RN2-0.8-6-0.1-V			6						7.55	6.37	6.62	6.86	7.11	7.68	●

● Stock ○ Available upon Order

R	Tol.
R	±0.005

(mm)

Cutting Parameters ※ P480

SPM200-RN2 NEW

2 Flute, Extended Neck-Corner Radius End Mill

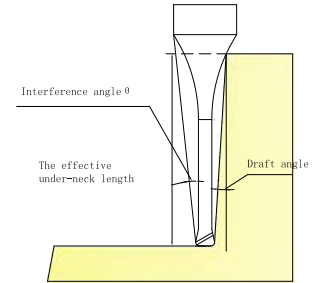
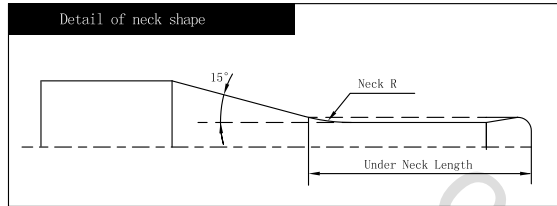

See page 97 for guidelines to icons

» Continue

Ordering Code	Mill Dia. D	Corner Radius R	Under Neck Length L1	Flute Length Lc	Neck Dia. d2	Overall Length L	Shank Dia. d	Neck R	Interference Angle θ	The effective under-neck length for the various draft angles					Stock	
										0.5°	1°	1.5°	2°	3°		
SPM200-RN2-0.8-8-0.1-V	0.8	0.1	8	0.64	0.76	50	4	4	6.49	8.45	8.76	9.07	9.41	10.17	●	
SPM200-RN2-0.8-12-0.1-V			12			55				5.06	12.60	13.04	13.51	14.01	15.14	●
SPM200-RN2-0.8-4-0.2-V		0.2	4			50				9.12	4.26	4.46	4.63	4.80	5.17	●
SPM200-RN2-0.8-6-0.2-V			6			50				7.62	6.36	6.61	6.85	7.10	7.66	●
SPM200-RN2-0.8-8-0.2-V			8			50				6.54	8.45	8.75	9.06	9.40	10.14	●
SPM200-RN2-0.8-12-0.2-V			12			55				5.09	12.60	13.03	13.50	14.00	15.11	●
SPM200-RN2-1-2-0.02-V	1	0.02	2	0.8	0.96	50	4	4	10.92	2.15	2.28	2.40	2.52	2.73	●	
SPM200-RN2-1-4-0.02-V			4			50				8.72	4.27	4.47	4.65	4.82	5.21	●
SPM200-RN2-1-6-0.02-V			6			50				7.26	6.37	6.63	6.87	7.12	7.70	●
SPM200-RN2-1-8-0.02-V			8			50				6.22	8.46	8.77	9.08	9.42	10.19	●
SPM200-RN2-1-10-0.02-V			10			50				5.44	10.53	10.91	11.30	11.72	12.67	●
SPM200-RN2-1-12-0.02-V			12			55				4.83	12.61	13.05	13.52	14.02	15.16	●
SPM200-RN2-1-2-0.05-V		0.05	2			50				10.96	2.15	2.28	2.40	2.51	2.72	●
SPM200-RN2-1-3-0.05-V			3			50				9.73	3.21	3.38	3.53	3.67	3.96	●
SPM200-RN2-1-4-0.05-V			4			50				8.75	4.27	4.47	4.65	4.82	5.21	●
SPM200-RN2-1-5-0.05-V			5			50				7.95	5.32	5.55	5.75	5.97	6.45	●
SPM200-RN2-1-6-0.05-V			6			50				7.28	6.37	6.63	6.86	7.12	7.69	●
SPM200-RN2-1-8-0.05-V			8			50				6.23	8.45	8.76	9.08	9.42	10.18	●
SPM200-RN2-1-10-0.05-V	10		50	5.45	10.53	10.90	11.30	11.72	12.67	●						
SPM200-RN2-1-12-0.05-V	12		55	4.84	12.61	13.04	13.51	14.02	15.15	●						
SPM200-RN2-1-16-0.05-V	16		60	3.95	16.74	17.32	17.95	18.62	20.12	●						
SPM200-RN2-1-20-0.05-V	20		60	3.34	20.88	21.60	22.38	23.22	25.10	●						
SPM200-RN2-1-2-0.1-V	0.1	2	50	11.03	2.14	2.27	2.39	2.50	2.71	●						
SPM200-RN2-1-3-0.1-V		3	50	9.79	3.21	3.38	3.53	3.66	3.95	●						

● Stock ○ Available upon Order

R	Tol.
R	±0.005

(mm)

Cutting Parameters ※ P480

SPM200-RN2 NEW

2 Flute, Extended Neck-Corner Radius End Mill

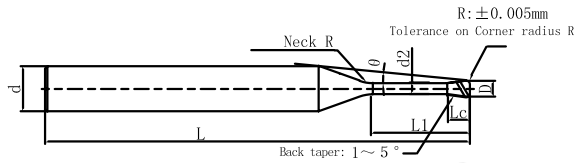

Φ4 or higher does not have backdraft shape



See page 97 for guidelines to icons

» Continue

Ordering Code	Mill Dia. D	Corner Radius R	Under Neck Length L1	Flute Length Lc	Neck Dia. d2	Overall Length L	Shank Dia. d	Neck R	Interference Angle θ	The effective under-neck length for the various draft angles					Stock					
										0.5°	1°	1.5°	2°	3°						
SPM200-RN2-1-4-0.1-V	1	0.1	4	0.8	0.96	50	4	4	8.80	4.26	4.47	4.64	4.81	5.19	●					
SPM200-RN2-1-5-0.1-V			5			50			7.99	5.32	5.55	5.75	5.96	6.44	●					
SPM200-RN2-1-6-0.1-V			6			50			7.31	6.37	6.62	6.86	7.11	7.68	●					
SPM200-RN2-1-8-0.1-V			8			50			6.25	8.45	8.76	9.07	9.41	10.17	●					
SPM200-RN2-1-10-0.1-V			10			50			5.46	10.53	10.90	11.29	11.71	12.65	●					
SPM200-RN2-1-12-0.1-V			12			55			4.85	12.60	13.04	13.51	14.01	15.14	●					
SPM200-RN2-1-16-0.1-V			16			60			3.96	16.74	17.32	17.94	18.61	20.11	●					
SPM200-RN2-1-20-0.1-V			20			60			3.35	20.87	21.60	22.37	23.21	25.08	●					
SPM200-RN2-1-2-0.2-V			0.2			2			0.8	0.96	50	4	4	11.17	2.14	2.26	2.38	2.48	2.68	●
SPM200-RN2-1-3-0.2-V						3					50			9.90	3.20	3.37	3.51	3.65	3.93	●
SPM200-RN2-1-4-0.2-V						4					50			8.89	4.26	4.46	4.63	4.80	5.17	●
SPM200-RN2-1-5-0.2-V						5					50			8.06	5.31	5.54	5.74	5.95	6.41	●
SPM200-RN2-1-6-0.2-V		6		50	7.37	6.36	6.61	6.85			7.10			7.66	●					
SPM200-RN2-1-8-0.2-V		8		50	6.30	8.45	8.75	9.06			9.40			10.14	●					
SPM200-RN2-1-10-0.2-V		10		50	5.50	10.53	10.89	11.28			11.70			12.63	●					
SPM200-RN2-1-12-0.2-V		12		55	4.88	12.60	13.03	13.50			14.00			15.11	●					
SPM200-RN2-1-16-0.2-V		16		60	3.98	16.74	17.31	17.93			18.59			20.09	●					
SPM200-RN2-1-20-0.2-V		20		60	3.36	20.87	21.59	22.36			23.19			25.06	●					
SPM200-RN2-1-2-0.3-V		0.3		2	0.8	0.96	50	4			4			11.32	2.13	2.25	2.36	2.47	2.66	●
SPM200-RN2-1-3-0.3-V				3			50							10.01	3.20	3.36	3.50	3.63	3.90	●
SPM200-RN2-1-4-0.3-V			4	50			8.98		4.25	4.45		4.62	4.78	5.15	●					
SPM200-RN2-1-5-0.3-V			5	50			8.14		5.31	5.53		5.73	5.93	6.39	●					
SPM200-RN2-1-6-0.3-V			6	50			7.44		6.36	6.61		6.84	7.08	7.63	●					
SPM200-RN2-1-8-0.3-V			8	50			6.35		8.44	8.75		9.05	9.38	10.12	●					

● Stock ○ Available upon Order

R	Tol.
R	±0.005

(mm)

Cutting Parameters ※ P480

SPM200-RN2 NEW

2 Flute, Extended Neck-Corner Radius End Mill

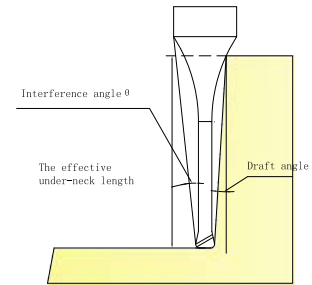
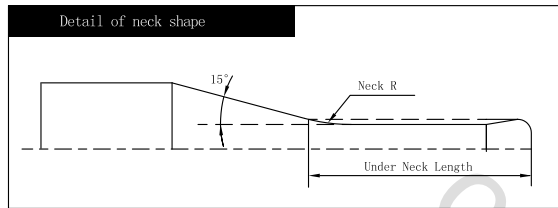

See page 97 for guidelines to icons

» Continue

Ordering Code	Mill Dia. D	Corner Radius R	Under Neck Length L1	Flute Length Lc	Neck Dia. d2	Overall Length L	Shank Dia. d	Neck R	Interference Angle θ	The effective under-neck length for the various draft angles					Stock						
										0.5°	1°	1.5°	2°	3°							
SPM200-RN2-1-10-0.3-V	1	0.3	10	0.8	0.96	50	4	4	5.53	10.52	10.89	11.27	11.68	12.60	●						
SPM200-RN2-1-12-0.3-V			12			12.60				13.03	13.49	13.98	15.09	●							
SPM200-RN2-1-16-0.3-V			16			16.73				17.30	17.92	18.58	20.06	●							
SPM200-RN2-1-20-0.3-V			20			20.87				21.58	22.35	23.18	25.04	●							
SPM200-RN2-1.25-5-0.1-V	1.25	0.1	5	1	1.20	50	4	4	7.68	5.30	5.52	5.72	5.93	6.40	●						
SPM200-RN2-1.25-10-0.1-V			10			10.50				10.87	11.26	11.68	12.62	●							
SPM200-RN2-1.25-15-0.1-V			15			15.68				16.22	16.80	17.43	18.83	●							
SPM200-RN2-1.25-20-0.1-V			20			20.84				21.57	22.34	23.18	25.05	●							
SPM200-RN2-1.25-5-0.2-V		0.2	5			50				7.75	5.29	5.51	5.71	5.91	6.38	●					
SPM200-RN2-1.25-10-0.2-V			10			50				5.21	10.50	10.86	11.25	11.66	12.59	●					
SPM200-RN2-1.25-15-0.2-V			15			55				3.92	15.67	16.21	16.79	17.41	18.81	●					
SPM200-RN2-1.25-20-0.2-V			20			60				3.14	20.84	21.56	22.33	23.16	25.02	●					
SPM200-RN2-1.25-5-0.3-V		0.3	5			50				7.83	5.29	5.50	5.70	5.90	6.35	●					
SPM200-RN2-1.25-10-0.3-V			10			50				5.24	10.50	10.86	11.24	11.65	12.57	●					
SPM200-RN2-1.25-15-0.3-V			15			55				3.94	15.67	16.20	16.78	17.40	18.78	●					
SPM200-RN2-1.25-20-0.3-V			20			60				3.15	20.84	21.55	22.32	23.15	25.00	●					
SPM200-RN2-1.5-4-0.1-V		1.5	0.1			4				1.2	1.44	50	4	4	8.17	4.23	4.42	4.58	4.75	5.13	●
SPM200-RN2-1.5-6-0.1-V						6						6.66				6.32	6.57	6.80	7.05	7.62	●
SPM200-RN2-1.5-8-0.1-V						8						5.62				8.41	8.71	9.02	9.35	10.10	●
SPM200-RN2-1.5-12-0.1-V						12						4.28				12.55	12.98	13.45	13.95	15.07	●
SPM200-RN2-1.5-15-0.1-V	15			3.63	15.65	16.19	16.77	17.40	18.80			●									
SPM200-RN2-1.5-20-0.1-V	20			2.90	20.82	21.54	22.32	23.15	-			●									
SPM200-RN2-1.5-4-0.2-V	0.2		4	50	8.26	4.23	4.41	4.57	4.74			5.10				●					
SPM200-RN2-1.5-6-0.2-V			6	50	6.72	6.32	6.56	6.79	7.04			7.59				●					

● Stock ○ Available upon Order

R	Tol.
R	±0.005

(mm)

Cutting Parameters ※ P480

SPM200-RN2 NEW

2 Flute, Extended Neck-Corner Radius End Mill

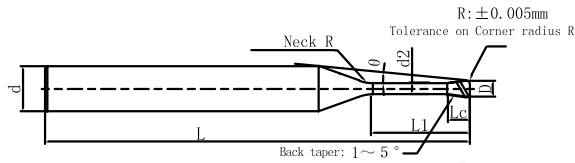

Φ4 or higher does not have backdraft shape



See page 97 for guidelines to icons

» Continue

Ordering Code	Mill Dia. D	Corner Radius R	Under Neck Length L1	Flute Length Lc	Neck Dia. d2	Overall Length L	Shank Dia. d	Neck R	Interference Angle θ	The effective under-neck length for the various draft angles					Stock	
										0.5°	1°	1.5°	2°	3°		
SPM200-RN2-1.5-8-0.2-V	1.5	0.2	8	1.2	1.44	50	4	4	5.66	8.40	8.70	9.01	9.34	10.08	●	
SPM200-RN2-1.5-12-0.2-V			12			55			4.31	12.55	12.98	13.44	13.94	15.05	●	
SPM200-RN2-1.5-15-0.2-V			15			55			3.65	15.65	16.19	16.76	17.38	18.78	●	
SPM200-RN2-1.5-20-0.2-V			20			60			2.91	20.82	21.53	22.31	23.13	-	●	
SPM200-RN2-1.5-4-0.3-V		0.3	4			50			8.36	4.22	4.40	4.56	4.72	5.08	●	
SPM200-RN2-1.5-6-0.3-V			6			50			6.78	6.31	6.55	6.78	7.02	7.57	●	
SPM200-RN2-1.5-8-0.3-V			8			50			5.71	8.40	8.69	8.99	9.32	10.05	●	
SPM200-RN2-1.5-12-0.3-V			12			55			4.33	12.54	12.97	13.43	13.92	15.03	●	
SPM200-RN2-1.5-15-0.3-V			15			55			3.67	15.64	16.18	16.75	17.37	18.76	●	
SPM200-RN2-1.5-20-0.3-V			20			60			2.92	20.81	21.53	22.29	23.12	-	●	
SPM200-RN2-1.5-4-0.5-V			0.5			4			50	8.55	4.21	4.39	4.54	4.69	5.03	●
SPM200-RN2-1.5-6-0.5-V						6			50	6.91	6.31	6.54	6.76	6.99	7.52	●
SPM200-RN2-1.5-8-0.5-V		8				50			5.80	8.39	8.68	8.97	9.29	10.00	●	
SPM200-RN2-1.5-12-0.5-V		12				55			4.39	12.54	12.96	13.41	13.89	14.98	●	
SPM200-RN2-1.5-15-0.5-V		15				55			3.71	15.64	16.17	16.73	17.34	18.71	●	
SPM200-RN2-1.5-20-0.5-V		20				60			2.95	20.81	21.51	22.27	23.09	-	●	
SPM200-RN2-1.75-5-0.1-V	1.75	0.1		5	1.4	1.68	50	4	4	6.96	5.26	5.47	5.67	5.88	6.35	●
SPM200-RN2-1.75-10-0.1-V				10			50			4.53	10.46	10.82	11.21	11.63	12.56	●
SPM200-RN2-1.75-15-0.1-V			15	55			3.35			15.63	16.17	16.75	17.38	18.78	●	
SPM200-RN2-1.75-20-0.1-V			20	60			2.66			20.80	21.52	22.29	23.13	-	●	
SPM200-RN2-1.75-5-0.2-V		0.2	5	50			7.03			5.26	5.47	5.66	5.86	6.32	●	
SPM200-RN2-1.75-10-0.2-V			10	50			4.56			10.46	10.82	11.20	11.61	12.54	●	
SPM200-RN2-1.75-15-0.2-V			15	55			3.37			15.63	16.16	16.74	17.36	18.75	●	
SPM200-RN2-1.75-20-0.2-V			20	60			2.67			20.80	21.51	22.28	23.11	-	●	

● Stock ○ Available upon Order

R	Tol.
R	±0.005

(mm)

Cutting Parameters ※ P480

SPM200-RN2 NEW

2 Flute, Extended Neck-Corner Radius End Mill

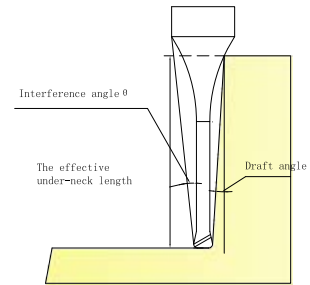
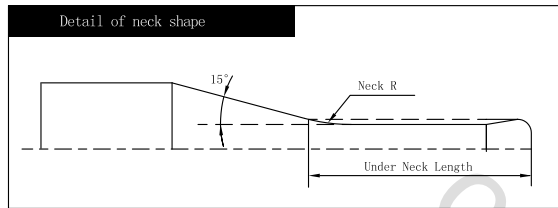

See page 97 for guidelines to icons

» Continue

Ordering Code	Mill Dia. D	Corner Radius R	Under Neck Length L1	Flute Length Lc	Neck Dia. d2	Overall Length L	Shank Dia. d	Neck R	Interference Angle θ	The effective under-neck length for the various draft angles					Stock	
										0.5°	1°	1.5°	2°	3°		
SPM200-RN2-1.75-5-0.3-V	1.75	0.3	5	1.4	1.68	50	4	4	7.11	5.25	5.46	5.65	5.85	6.30	●	
SPM200-RN2-1.75-10-0.3-V			10			4.59			10.45	10.81	11.19	11.60	12.51	●		
SPM200-RN2-1.75-15-0.3-V			15			3.39			15.62	16.16	16.73	17.35	18.73	●		
SPM200-RN2-1.75-20-0.3-V			20			2.69			20.79	21.51	22.27	23.10	-	●		
SPM200-RN2-2-4-0.1-V	2	0.1	4	1.6	1.92	50	4	4	7.36	4.21	4.38	4.54	4.71	5.08	●	
SPM200-RN2-2-6-0.1-V			6			5.86			6.29	6.53	6.76	7.01	7.57	●		
SPM200-RN2-2-8-0.1-V			8			4.87			8.37	8.66	8.97	9.31	10.05	●		
SPM200-RN2-2-12-0.1-V			12			3.64			12.51	12.94	13.41	13.91	15.03	●		
SPM200-RN2-2-16-0.1-V			16			2.90			16.65	17.22	17.84	18.51	-	●		
SPM200-RN2-2-20-0.1-V			20			2.42			20.78	21.50	22.27	23.11	-	●		
SPM200-RN2-2-25-0.1-V			25			2.00			25.95	26.85	27.82	-	-	●		
SPM200-RN2-2-30-0.1-V			30			1.70			31.12	32.20	33.36	-	-	●		
SPM200-RN2-2-4-0.2-V		0.2	4	4	4	4	4	4	4	7.46	4.20	4.37	4.53	4.69	5.06	●
SPM200-RN2-2-6-0.2-V			6	5.93	6.29	6.52	6.75	6.99	7.54	●						
SPM200-RN2-2-8-0.2-V			8	4.91	8.37	8.66	8.96	9.29	10.03	●						
SPM200-RN2-2-12-0.2-V			12	3.66	12.51	12.94	13.40	13.89	15.00	●						
SPM200-RN2-2-16-0.2-V			16	2.92	16.64	17.22	17.83	18.49	-	●						
SPM200-RN2-2-20-0.2-V			20	2.43	20.78	21.49	22.26	23.09	-	●						
SPM200-RN2-2-25-0.2-V			25	2.00	25.95	26.84	27.80	-	-	●						
SPM200-RN2-2-30-0.2-V			30	1.71	31.11	32.19	33.35	-	-	●						
SPM200-RN2-2-4-0.3-V	0.3	4	4	4	4	4	4	4	7.56	4.20	4.37	4.52	4.68	5.03	●	
SPM200-RN2-2-6-0.3-V		6	5.99	6.28	6.51	6.74	6.98	7.52	●							
SPM200-RN2-2-8-0.3-V		8	4.96	8.36	8.65	8.95	9.28	10.01	●							
SPM200-RN2-2-12-0.3-V		12	3.69	12.50	12.93	13.39	13.88	14.98	●							

● Stock ○ Available upon Order

R	Tol.
R	±0.005

(mm)

Cutting Parameters ※ P480

SPM200-RN2 NEW

2 Flute, Extended Neck-Corner Radius End Mill

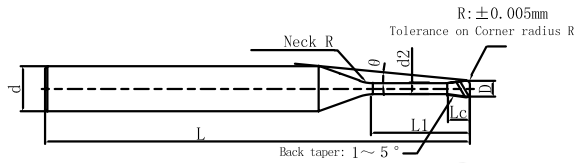

Φ4 or higher does not have backdraft shape



See page 97 for guidelines to icons

» Continue

Ordering Code	Mill Dia. D	Corner Radius R	Under Neck Length L1	Flute Length Lc	Neck Dia. d2	Overall Length L	Shank Dia. d	Neck R	Interference Angle θ	The effective under-neck length for the various draft angles					Stock
										0.5°	1°	1.5°	2°	3°	
SPM200-RN2-2-16-0.3-V	2	0.3	16	1.6	1.92	55	4	4	2.93	16.64	17.21	17.82	18.48	-	●
SPM200-RN2-2-20-0.3-V			20			60			2.44	20.77	21.49	22.25	23.08	-	●
SPM200-RN2-2-25-0.3-V			25			65			2.01	25.94	26.84	27.79	28.82	-	●
SPM200-RN2-2-30-0.3-V			30			70			1.71	31.11	32.18	33.34	-	-	●
SPM200-RN2-2-6-0.5-V		0.5	6			50			6.11	6.28	6.50	6.71	6.95	7.47	●
SPM200-RN2-2-8-0.5-V			8			50			5.04	8.36	8.64	8.93	9.25	9.96	●
SPM200-RN2-2-12-0.5-V			12			55			3.73	12.50	12.92	13.36	13.85	14.93	●
SPM200-RN2-2-16-0.5-V			16			55			2.96	16.63	17.19	17.80	18.45	-	●
SPM200-RN2-2-20-0.5-V			20			60			2.46	20.77	21.47	22.23	23.05	-	●
SPM200-RN2-2-25-0.5-V			25			65			2.03	25.94	26.82	27.77	28.79	-	●
SPM200-RN2-2-30-0.5-V			30			70			1.72	31.10	32.17	33.31	-	-	●
SPM200-RN2-2-6-0.8-V			0.8			6			50	6.31	6.26	6.48	6.68	6.90	7.40
SPM200-RN2-2-8-0.8-V		8				50			5.18	8.35	8.62	8.90	9.20	9.88	●
SPM200-RN2-2-12-0.8-V		12				55			3.81	12.49	12.89	13.33	13.80	14.86	●
SPM200-RN2-2-16-0.8-V		16				55			3.01	16.62	17.17	17.77	18.40	19.83	●
SPM200-RN2-2-20-0.8-V		20				60			2.49	20.76	21.45	22.20	23.00	-	●
SPM200-RN2-2-25-0.8-V	25	65		2.05	25.93	26.80	27.74	28.75	-	●					
SPM200-RN2-2-30-0.8-V	30	70		1.74	31.09	32.15	33.28	-	-	●					
SPM200-RN2-2.5-10-0.1-V	2.5	0.1		10	2	2.40	50	4	4	3.36	10.41	10.77	11.16	11.57	12.50
SPM200-RN2-2.5-20-0.1-V			20	60			1.89			20.75	21.47	22.24	-	-	●
SPM200-RN2-2.5-30-0.1-V			30	70			1.32			31.09	32.17	-	-	-	●
SPM200-RN2-2.5-10-0.2-V		0.2	10	50			3.39			10.41	10.77	11.15	11.56	12.48	●
SPM200-RN2-2.5-20-0.2-V			20	60			1.90			20.75	21.46	22.23	-	-	●
SPM200-RN2-2.5-30-0.2-V			30	70			1.32			31.08	32.16	-	-	-	●

● Stock ○ Available upon Order

R	Tol.
R	±0.005

(mm)

Cutting Parameters ※ P480

SPM200-RN2 NEW

2 Flute, Extended Neck-Corner Radius End Mill

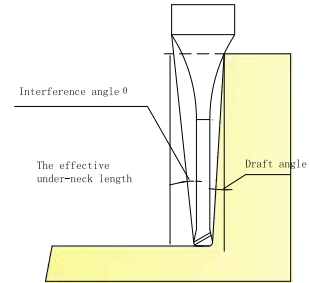
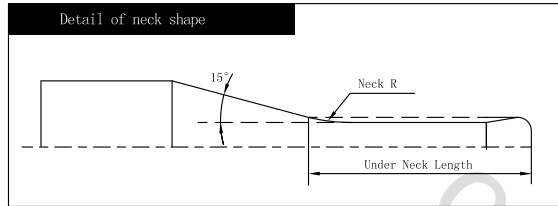

See page 97 for guidelines to icons

» Continue

Ordering Code	Mill Dia. D	Corner Radius R	Under Neck Length L1	Flute Length Lc	Neck Dia. d2	Overall Length L	Shank Dia. d	Neck R	Interference Angle θ	The effective under-neck length for the various draft angles					Stock
										0.5°	1°	1.5°	2°	3°	
SPM200-RN2-2.5-10-0.3-V	2.5	0.3	10	2	2.40	50	4	4	3.42	10.41	10.76	11.14	11.54	12.46	●
SPM200-RN2-2.5-20-0.3-V			20			60			1.91	20.74	21.46	22.22	-	-	●
SPM200-RN2-2.5-30-0.3-V			30			70			1.32	31.08	32.15	-	-	-	●
SPM200-RN2-2.5-10-0.5-V		0.5	10			50			3.47	10.40	10.75	11.12	11.51	12.41	●
SPM200-RN2-2.5-20-0.5-V			20			60			1.92	20.74	21.44	22.20	-	-	●
SPM200-RN2-2.5-30-0.5-V			30			70			1.33	31.07	32.14	-	-	-	●
SPM200-RN2-3-6-0.1-V	3	0.1	6	2.4	2.88	50	6	4	7.40	6.25	6.47	6.70	6.95	7.50	●
SPM200-RN2-3-8-0.1-V			8			55			6.32	8.32	8.61	8.92	9.25	9.99	●
SPM200-RN2-3-12-0.1-V			12			60			4.89	12.46	12.89	13.35	13.85	14.96	●
SPM200-RN2-3-16-0.1-V			16			60			3.99	16.59	17.17	17.78	18.45	19.94	●
SPM200-RN2-3-18-0.1-V			18			65			3.65	18.66	19.31	20.00	20.75	22.42	●
SPM200-RN2-3-20-0.1-V			20			65			3.36	20.73	21.45	22.22	23.05	24.91	●
SPM200-RN2-3-30-0.1-V			30			75			2.42	31.06	32.14	33.30	34.55	-	●
SPM200-RN2-3-35-0.1-V			35			80			2.12	36.23	37.49	38.84	40.29	-	●
SPM200-RN2-3-6-0.2-V			0.2			6			50	7.46	6.25	6.46	6.69	6.93	7.48
SPM200-RN2-3-8-0.2-V		8		55	6.36	8.32	8.60	8.91	9.23	9.97	●				
SPM200-RN2-3-12-0.2-V		12		60	4.92	12.45	12.88	13.34	13.83	14.94	●				
SPM200-RN2-3-16-0.2-V		16		60	4.00	16.59	17.16	17.77	18.43	19.91	●				
SPM200-RN2-3-18-0.2-V		18		65	3.66	18.66	19.30	19.99	20.73	22.40	●				
SPM200-RN2-3-20-0.2-V		20		65	3.38	20.72	21.44	22.21	23.03	24.88	●				
SPM200-RN2-3-30-0.2-V		30		75	2.43	31.06	32.14	33.29	34.53	-	●				
SPM200-RN2-3-35-0.2-V		35		80	2.13	36.23	37.48	38.83	40.28	-	●				
SPM200-RN2-3-6-0.3-V		0.3		6	50	7.53	6.24	6.46	6.68	6.92	7.46	●			
SPM200-RN2-3-8-0.3-V			8	55	6.41	8.32	8.60	8.90	9.22	9.94	●				

● Stock ○ Available upon Order

R	Tol.
R	±0.005

(mm)

Cutting Parameters ※ P480

SPM200-RN2 NEW

2 Flute, Extended Neck-Corner Radius End Mill

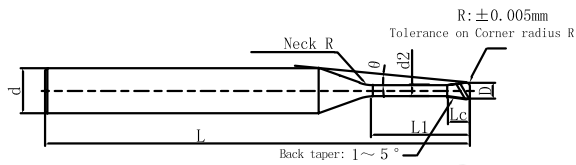

Φ4 or higher does not have backdraft shape



See page 97 for guidelines to icons

» Continue

Ordering Code	Mill Dia. D	Corner Radius R	Under Neck Length L1	Flute Length Lc	Neck Dia. d2	Overall Length L	Shank Dia. d	Neck R	Interference Angle θ	The effective under-neck length for the various draft angles					Stock	
										0.5°	1°	1.5°	2°	3°		
SPM200-RN2-3-12-0.3-V	3	0.3	12	2.4	2.88	60	6	4	4.94	12.45	12.87	13.33	13.82	14.91	●	
SPM200-RN2-3-16-0.3-V			16			60			4.02	16.59	17.15	17.76	18.42	19.89	●	
SPM200-RN2-3-18-0.3-V			18			65			3.68	18.65	19.29	19.98	20.72	22.37	●	
SPM200-RN2-3-20-0.3-V			20			65			3.39	20.72	21.43	22.20	23.02	24.86	●	
SPM200-RN2-3-30-0.3-V			30			75			2.43	31.06	32.13	33.28	34.52	-	●	
SPM200-RN2-3-35-0.3-V			35			80			2.13	36.23	37.48	38.82	40.26	-	●	
SPM200-RN2-3-8-0.5-V		0.5	8			55			6.51	8.31	8.58	8.87	9.19	9.89	●	
SPM200-RN2-3-12-0.5-V			12			60			5.00	12.44	12.86	13.31	13.79	14.87	●	
SPM200-RN2-3-16-0.5-V			16			60			4.06	16.58	17.14	17.74	18.39	19.84	●	
SPM200-RN2-3-18-0.5-V			18			65			3.71	18.65	19.28	19.96	20.69	22.33	●	
SPM200-RN2-3-20-0.5-V			20			65			3.42	20.71	21.42	22.17	22.99	24.81	●	
SPM200-RN2-3-30-0.5-V			30			75			2.45	31.05	32.12	33.26	34.49	-	●	
SPM200-RN2-3-35-0.5-V			35			80			2.14	36.22	37.46	38.80	40.23	-	●	
SPM200-RN2-3-8-1-V			1			8			55	6.76	8.29	8.55	8.82	9.11	9.77	●
SPM200-RN2-3-12-1-V						12			60	5.15	12.43	12.83	13.25	13.71	14.74	●
SPM200-RN2-3-16-1-V						16			60	4.16	16.56	17.10	17.69	18.31	19.72	●
SPM200-RN2-3-18-1-V						18			65	3.79	18.63	19.24	19.90	20.61	22.20	●
SPM200-RN2-3-20-1-V						20			65	3.49	20.70	21.38	22.12	22.91	24.69	●
SPM200-RN2-3-30-1-V						30			75	2.48	31.03	32.08	33.20	34.41	-	●
SPM200-RN2-3-35-1-V						35			80	2.17	36.20	37.43	38.74	40.16	-	●
SPM200-RN2-4-8-0.1-V	4	0.1		8	3.2	3.86	55	6	4	4.90	8.31	8.59	8.90	9.23	9.97	●
SPM200-RN2-4-12-0.1-V			12	60			3.66			12.44	12.87	13.33	13.83	14.94	●	
SPM200-RN2-4-16-0.1-V			16	60			2.91			16.57	17.15	17.76	18.43	-	●	
SPM200-RN2-4-20-0.1-V			20	65			2.42			20.71	21.43	22.20	23.03	-	●	

● Stock ○ Available upon Order

R	Tol.
R	±0.005

(mm)

Cutting Parameters ※ P480

SPM200-RN2 NEW

2 Flute, Extended Neck-Corner Radius End Mill

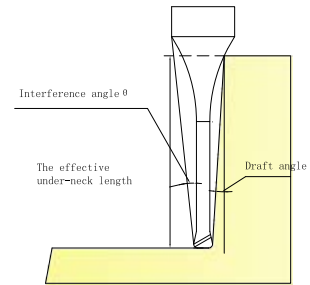
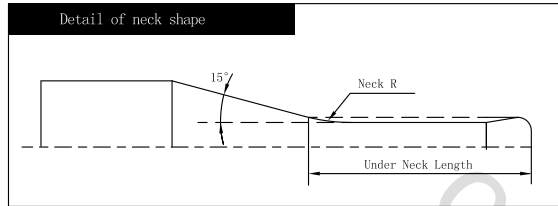

See page 97 for guidelines to icons

» Continue

Ordering Code	Mill Dia. D	Corner Radius R	Under Neck Length L1	Flute Length Lc	Neck Dia. d2	Overall Length L	Shank Dia. d	Neck R	Interference Angle θ	The effective under-neck length for the various draft angles					Stock
										0.5°	1°	1.5°	2°	3°	
SPM200-RN2-4-30-0.1-V	4	0.1	30	3.2	3.86	75	6	4	1.71	31.05	32.12	33.28	-	-	●
SPM200-RN2-4-35-0.1-V			35			80			1.49	36.21	37.47	-	-	-	●
SPM200-RN2-4-45-0.1-V			45			90			1.18	46.55	48.17	-	-	-	●
SPM200-RN2-4-8-0.2-V		0.2	8			55			4.94	8.30	8.58	8.89	9.21	9.94	●
SPM200-RN2-4-12-0.2-V			12			60			3.68	12.44	12.86	13.32	13.81	14.92	●
SPM200-RN2-4-16-0.2-V			16			60			2.93	16.57	17.14	17.75	18.41	-	●
SPM200-RN2-4-20-0.2-V			20			65			2.43	20.71	21.42	22.19	23.01	-	●
SPM200-RN2-4-30-0.2-V			30			75			1.71	31.04	32.12	33.27	-	-	●
SPM200-RN2-4-35-0.2-V			35			80			1.49	36.21	37.47	-	-	-	●
SPM200-RN2-4-45-0.2-V		45	90			1.18			46.55	48.16	-	-	-	●	
SPM200-RN2-4-8-0.3-V		0.3	8			55			4.99	8.30	8.58	8.88	9.20	9.92	●
SPM200-RN2-4-12-0.3-V			12			60			3.70	12.43	12.86	13.31	13.80	14.89	●
SPM200-RN2-4-16-0.3-V			16			60			2.94	16.57	17.13	17.74	18.40	-	●
SPM200-RN2-4-20-0.3-V			20			65			2.44	20.70	21.41	22.18	23.00	-	●
SPM200-RN2-4-30-0.3-V			30			75			1.72	31.04	32.11	33.26	-	-	●
SPM200-RN2-4-35-0.3-V			35			80			1.49	36.21	37.46	-	-	-	●
SPM200-RN2-4-45-0.3-V		45	90			1.19			46.54	48.16	-	-	-	●	
SPM200-RN2-4-12-0.5-V		0.5	12			60			3.75	12.43	12.84	13.29	13.77	14.84	●
SPM200-RN2-4-16-0.5-V			16			60			2.97	16.56	17.12	17.72	18.37	-	●
SPM200-RN2-4-20-0.5-V			20			65			2.47	20.70	21.40	22.15	22.97	-	●
SPM200-RN2-4-30-0.5-V	30		75	1.73	31.03	32.10	33.24	-	-	●					
SPM200-RN2-4-35-0.5-V	35		80	1.50	36.20	37.44	-	-	-	●					
SPM200-RN2-4-45-0.5-V	45		90	1.19	46.54	48.14	-	-	-	●					
SPM200-RN2-4-12-1-V	1	12	60	3.88	12.41	12.81	13.23	13.69	14.72	●					

● Stock ○ Available upon Order

R	Tol.
R	±0.005

(mm)

Cutting Parameters ※ P480

SPM200-RN2 NEW

2 Flute, Extended Neck-Corner Radius End Mill

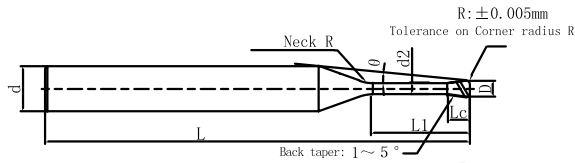

Φ4 or higher does not have backdraft shape



See page 97 for guidelines to icons

» Continue

Ordering Code	Mill Dia. D	Corner Radius R	Under Neck Length L1	Flute Length Lc	Neck Dia. d2	Overall Length L	Shank Dia. d	Neck R	Interference Angle θ	The effective under-neck length for the various draft angles					Stock
										0.5°	1°	1.5°	2°	3°	
SPM200-RN2-4-16-1-V	4	1	16	3.2	3.86	60	6	4	3.05	16.54	17.09	17.67	18.29	19.70	●
SPM200-RN2-4-20-1-V			20			65			2.52	20.68	21.36	22.10	22.89	-	●
SPM200-RN2-4-30-1-V			30			75			1.75	31.02	32.06	33.18	-	-	●
SPM200-RN2-4-35-1-V			35			80			1.52	36.18	37.41	38.73	-	-	●
SPM200-RN2-4-45-1-V			45			90			1.20	46.52	48.11	-	-	-	●
SPM200-RN2-5-20-0.1-V	5	0.1	20	4	4.85	65	6	4	1.32	20.70	21.42	-	-	-	●
SPM200-RN2-5-40-0.1-V			40			85			0.69	41.38	-	-	-	-	●
SPM200-RN2-5-20-0.2-V		0.2	20			65			1.32	20.70	21.41	-	-	-	●
SPM200-RN2-5-40-0.2-V			40			85			0.69	41.37	-	-	-	-	●
SPM200-RN2-5-20-0.3-V		0.3	20			65			1.33	20.69	21.41	-	-	-	●
SPM200-RN2-5-40-0.3-V			40			85			0.69	41.37	-	-	-	-	●
SPM200-RN2-5-20-0.5-V		0.5	20			65			1.34	20.69	21.39	-	-	-	●
SPM200-RN2-5-40-0.5-V			40			85			0.70	41.36	-	-	-	-	●
SPM200-RN2-5-20-1-V		1	20			65			1.38	20.67	21.36	-	-	-	●
SPM200-RN2-5-40-1-V			40			85			0.71	41.34	-	-	-	-	●
SPM200-RN2-6-12-0.1-V	6	0.1	12	4.8	5.85	50	6	-	-	-	-	-	-	-	●
SPM200-RN2-6-18-0.1-V			18			60			-	-	-	-	-	●	
SPM200-RN2-6-24-0.1-V			24			70			-	-	-	-	-	●	
SPM200-RN2-6-35-0.1-V			35			80			-	-	-	-	-	●	
SPM200-RN2-6-55-0.1-V			55			100			-	-	-	-	-	●	
SPM200-RN2-6-12-0.2-V		0.2	12			50			-	-	-	-	-	●	
SPM200-RN2-6-18-0.2-V			18			60			-	-	-	-	-	●	
SPM200-RN2-6-24-0.2-V			24			70			-	-	-	-	-	●	
SPM200-RN2-6-35-0.2-V			35			80			-	-	-	-	-	●	

● Stock ○ Available upon Order

R	Tol.
R	±0.005

(mm)

Cutting Parameters ※ P480

SPM200-RN2 NEW

2 Flute, Extended Neck-Corner Radius End Mill

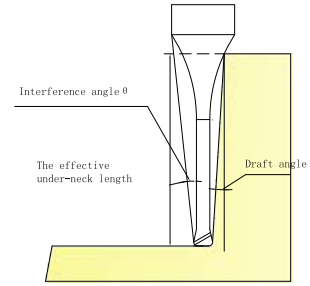
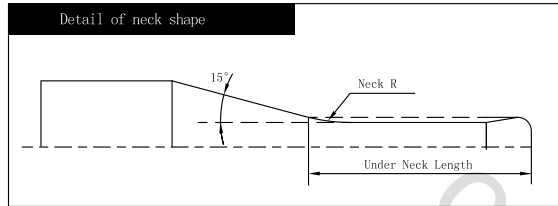

See page 97 for guidelines to icons

» Continue

Ordering Code	Mill Dia. D	Corner Radius R	Under Neck Length L1	Flute Length Lc	Neck Dia. d2	Overall Length L	Shank Dia. d	Neck R	Interference Angle θ	The effective under-neck length for the various draft angles					Stock
										0.5°	1°	1.5°	2°	3°	
SPM200-RN2-6-55-0.2-V	6	0.2	55	4.8	5.85	100	6	-	-	-	-	-	-	-	•
SPM200-RN2-6-12-0.3-V			12			50			-	-	-	-	-	•	
SPM200-RN2-6-18-0.3-V			18			60			-	-	-	-	-	•	
SPM200-RN2-6-24-0.3-V			24			70			-	-	-	-	-	•	
SPM200-RN2-6-35-0.3-V			35			80			-	-	-	-	-	•	
SPM200-RN2-6-55-0.3-V			55			100			-	-	-	-	-	•	
SPM200-RN2-6-18-0.5-V		0.5	18			60			-	-	-	-	-	•	
SPM200-RN2-6-24-0.5-V			24			70			-	-	-	-	-	•	
SPM200-RN2-6-35-0.5-V			35			80			-	-	-	-	-	•	
SPM200-RN2-6-55-0.5-V			55			100			-	-	-	-	-	•	
SPM200-RN2-6-18-1-V		1	18			60			-	-	-	-	-	•	
SPM200-RN2-6-24-1-V			24			70			-	-	-	-	-	•	
SPM200-RN2-6-35-1-V			35			80			-	-	-	-	-	•	
SPM200-RN2-6-55-1-V			55			100			-	-	-	-	-	•	

• Stock ◦ Available upon Order

R	Tol.
R	±0.005

(mm)

Cutting Parameters ※ P480

SPM200-BN2 NEW

2 Flute, Extended Neck-Ball Nose End Mill

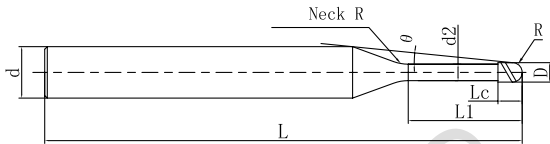

See page 97 for guidelines to icons

Ordering Code	Mill Dia. D	R	Under Neck Length L1	Flute Length Lc	Neck Dia. d2	Overall Length L	Shank Dia. d	Neck R	Interference Angle θ	The effective under-neck length for the various draft angles					Stock
										0.5°	1°	1.5°	2°	3°	
SPM200-BN2-0.1-0.2-V	0.1	0.05	0.2	0.08	0.08	50	4	1	14.66	0.2	0.21	0.22	0.24	0.26	●
SPM200-BN2-0.1-0.3-V			14.48						0.31	0.33	0.34	0.36	0.39	●	
SPM200-BN2-0.1-0.5-V			14.12						0.52	0.55	0.57	0.59	0.64	●	
SPM200-BN2-0.2-0.5-V	0.2	0.1	0.5	0.16	0.17	50	4	1	14.21	0.51	0.53	0.55	0.57	0.61	●
SPM200-BN2-0.2-0.75-V			13.77						0.78	0.8	0.83	0.86	0.92	●	
SPM200-BN2-0.2-1-V			13.36						1.04	1.07	1.11	1.15	1.23	●	
SPM200-BN2-0.2-1.25-V			12.97						1.3	1.34	1.39	1.43	1.54	●	
SPM200-BN2-0.2-1.5-V			12.6						1.56	1.61	1.66	1.72	1.85	●	
SPM200-BN2-0.2-2-V			11.92						2.07	2.14	2.22	2.3	2.48	●	
SPM200-BN2-0.2-2.5-V			11.31						2.59	2.68	2.77	2.87	3.1	●	
SPM200-BN2-0.2-3-V			10.76						3.11	3.21	3.33	3.45	3.72	●	
SPM200-BN2-0.3-0.5-V			0.3						0.15	0.5	0.24	0.27	50	4	2
SPM200-BN2-0.3-0.75-V	13.72	0.79		0.83	0.87	0.91	0.98	●							
SPM200-BN2-0.3-1-V	13.3	1.05		1.11	1.16	1.2	1.29	●							
SPM200-BN2-0.3-1.25-V	12.9	1.32		1.38	1.44	1.5	1.61	●							
SPM200-BN2-0.3-1.5-V	12.53	1.58		1.66	1.72	1.78	1.92	●							
SPM200-BN2-0.3-2-V	11.84	2.11		2.2	2.28	2.36	2.54	●							
SPM200-BN2-0.3-2.5-V	11.22	2.63		2.74	2.83	2.93	3.16	●							
SPM200-BN2-0.3-3-V	10.66	3.15		3.27	3.39	3.51	3.78	●							
SPM200-BN2-0.4-0.75-V	0.4	0.2	0.75	0.32	0.37	50	4	2	13.78	0.78	0.82	0.86	0.9	0.97	●
SPM200-BN2-0.4-1-V			13.34						1.05	1.1	1.15	1.19	1.28	●	
SPM200-BN2-0.4-1.5-V			12.55						1.58	1.65	1.72	1.78	1.9	●	
SPM200-BN2-0.4-2-V			11.84						2.11	2.19	2.27	2.35	2.53	●	
SPM200-BN2-0.4-2.5-V			11.2						2.63	2.73	2.83	2.93	3.15	●	

● Stock ○ Available upon Order

R	Tol.
R ≤ 0.25	±0.003
R > 0.25	±0.005

(mm)

Cutting Parameters * P502

SPM200-BN2 NEW

2 Flute, Extended Neck-Ball Nose End Mill

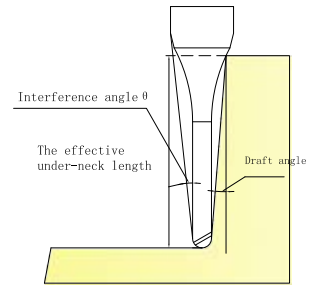
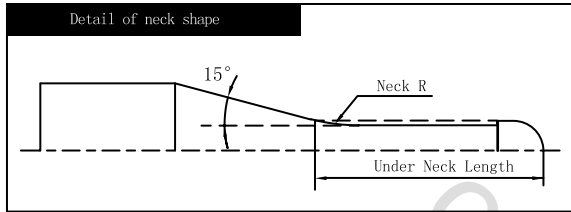

See page 97 for guidelines to icons

» Continue

Ordering Code	Mill Dia. D	R	Under Neck Length L1	Flute Length Lc	Neck Dia. d2	Overall Length L	Shank Dia. d	Neck R	Interference Angle θ	The effective under-neck length for the various draft angles					Stock
										0.5°	1°	1.5°	2°	3°	
SPM200-BN2-0.4-3-V	0.4	0.2	3	0.32	0.37	50	4	2	10.63	3.15	3.27	3.38	3.5	3.77	●
SPM200-BN2-0.4-3.5-V			3.5							3.67	3.8	3.94	4.08	4.39	●
SPM200-BN2-0.4-4-V			4							4.19	4.34	4.49	4.65	5.01	●
SPM200-BN2-0.4-4.5-V			4.5							4.71	4.87	5.04	5.23	5.63	●
SPM200-BN2-0.5-1-V	0.5	0.25	1	0.4	0.47	50	4	2	13.39	1.05	1.09	1.14	1.19	1.27	●
SPM200-BN2-0.5-1.5-V			1.5							1.58	1.65	1.71	1.77	1.89	●
SPM200-BN2-0.5-2-V			2							2.1	2.19	2.27	2.34	2.51	●
SPM200-BN2-0.5-2.5-V			2.5							2.63	2.73	2.82	2.92	3.14	●
SPM200-BN2-0.5-3-V			3							3.15	3.27	3.38	3.49	3.76	●
SPM200-BN2-0.5-4-V			4							4.19	4.34	4.48	4.64	5	●
SPM200-BN2-0.5-5-V			5							5.23	5.41	5.59	5.79	6.24	●
SPM200-BN2-0.5-5.5-V			5.5							6.4	6.59	6.77	6.97	7.49	●
SPM200-BN2-0.5-6-V			6							7.27	7.48	7.67	7.87	8.49	●
SPM200-BN2-0.5-8-V			8							9.23	9.62	10.01	10.4	11.97	●
SPM200-BN2-0.6-1-V	0.6	0.3	1	0.48	0.57	50	4	4	13.15	1.07	1.14	1.2	1.27	1.41	●
SPM200-BN2-0.6-2-V			2							2.15	2.28	2.39	2.5	2.7	●
SPM200-BN2-0.6-2.5-V			2.5							2.68	2.84	2.97	3.09	3.32	●
SPM200-BN2-0.6-3-V			3							3.22	3.39	3.54	3.67	3.95	●
SPM200-BN2-0.6-3.5-V			3.5							3.75	3.94	4.1	4.25	4.57	●
SPM200-BN2-0.6-4-V			4							4.28	4.48	4.66	4.82	5.19	●
SPM200-BN2-0.6-4.5-V			4.5							4.81	5.03	5.21	5.4	5.81	●
SPM200-BN2-0.6-5-V			5							5.33	5.57	5.77	5.97	6.43	●
SPM200-BN2-0.6-5.5-V			5.5							5.86	6.11	6.32	6.55	7.05	●
SPM200-BN2-0.6-6-V			6							6.38	6.64	6.87	7.12	7.67	●

● Stock ○ Available upon Order

R	Tol.
R ≤ 0.25	±0.003
R > 0.25	±0.005

(mm)

Cutting Parameters ※ P502

SPM200-BN2 NEW

2 Flute, Extended Neck-Ball Nose End Mill

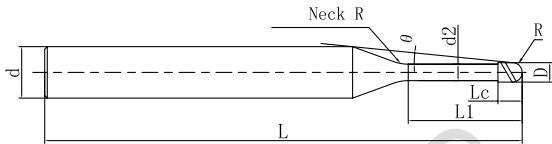

See page 97 for guidelines to icons

» Continue

Ordering Code	Mill Dia. D	R	Under Neck Length L1	Flute Length Lc	Neck Dia. d2	Overall Length L	Shank Dia. d	Neck R	Interference Angle θ	The effective under-neck length for the various draft angles					Stock
										0.5°	1°	1.5°	2°	3°	
SPM200-BN2-0.6-7-V	0.6	0.3	7	0.48	0.57	50	4	4	7.3	7.43	7.71	7.98	8.27	8.92	●
SPM200-BN2-0.6-8-V			6.79						8.48	8.78	9.09	9.42	10.16	●	
SPM200-BN2-0.6-9-V			6.35						9.52	9.85	10.2	10.57	11.4	●	
SPM200-BN2-0.6-10-V			5.97						10.56	10.92	11.31	11.72	12.65	●	
SPM200-BN2-0.6-12-V			5.32						12.63	13.06	13.52	14.02	15.13	●	
SPM200-BN2-0.7-2-V	0.7	0.35	2	0.56	0.67	50	4	4	11.6	2.14	2.27	2.39	2.49	2.69	●
SPM200-BN2-0.7-4-V			9.33						4.27	4.48	4.65	4.81	5.18	●	
SPM200-BN2-0.7-6-V			7.81						6.38	6.64	6.87	7.11	7.66	●	
SPM200-BN2-0.7-8-V			6.71						8.47	8.78	9.09	9.41	10.15	●	
SPM200-BN2-0.8-2-V	0.8	0.4	2	0.64	0.76	50	4	4	11.64	2.12	2.24	2.35	2.45	2.63	●
SPM200-BN2-0.8-4-V			9.3						4.25	4.44	4.61	4.77	5.12	●	
SPM200-BN2-0.8-5-V			8.45						5.3	5.53	5.72	5.92	6.36	●	
SPM200-BN2-0.8-6-V			7.74						6.35	6.6	6.83	7.07	7.61	●	
SPM200-BN2-0.8-8-V			6.63						8.44	8.74	9.04	9.37	10.09	●	
SPM200-BN2-0.8-10-V	5.8	10.52	10.88	11.26	11.67	12.58	●								
SPM200-BN2-0.9-2-V	0.9	0.45	2	0.72	0.86	50	4	4	11.63	2.12	2.23	2.34	2.44	2.62	●
SPM200-BN2-0.9-4-V			9.24						4.25	4.44	4.6	4.76	5.11	●	
SPM200-BN2-0.9-6-V			7.66						6.35	6.6	6.82	7.06	7.6	●	
SPM200-BN2-0.9-8-V			6.54						8.44	8.74	9.04	9.36	10.08	●	
SPM200-BN2-1-2-V	1	0.5	2	0.8	0.96	50	4	4	11.62	2.12	2.23	2.33	2.43	2.61	●
SPM200-BN2-1-3-V			10.25						3.18	3.34	3.48	3.6	3.85	●	
SPM200-BN2-1-4-V			9.17						4.24	4.43	4.6	4.75	5.1	●	
SPM200-BN2-1-5-V			8.29						5.3	5.52	5.71	5.9	6.34	●	
SPM200-BN2-1-6-V			7.57						6.35	6.59	6.81	7.05	7.58	●	

● Stock ○ Available upon Order

R	Tol.
R ≤ 0.25	±0.003
R > 0.25	±0.005

(mm)

Cutting Parameters ※ P502

SPM200-BN2 NEW

2 Flute, Extended Neck-Ball Nose End Mill

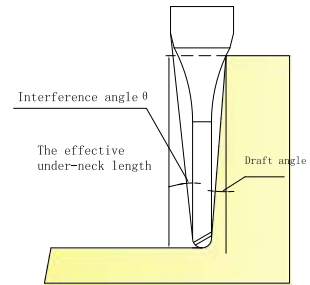
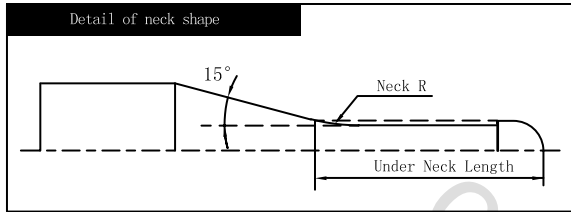

See page 97 for guidelines to icons

» Continue

Ordering Code	Mill Dia. D	R	Under Neck Length L1	Flute Length Lc	Neck Dia. d2	Overall Length L	Shank Dia. d	Neck R	Interference Angle θ	The effective under-neck length for the various draft angles					Stock
										0.5°	1°	1.5°	2°	3°	
SPM200-BN2-1-7-V	1	0.5	7	0.8	0.96	50	4	4	6.96	7.39	7.66	7.92	8.2	8.83	●
SPM200-BN2-1-8-V			8			50			6.44	8.44	8.73	9.03	9.35	10.07	●
SPM200-BN2-1-9-V			9			50			5.99	9.48	9.8	10.14	10.5	11.31	●
SPM200-BN2-1-10-V			10			50			5.6	10.52	10.87	11.25	11.65	12.56	●
SPM200-BN2-1-12-V			12			55			4.96	12.59	13.01	13.46	13.95	15.04	●
SPM200-BN2-1-13-V			13			55			4.69	13.62	14.08	14.57	15.1	16.29	●
SPM200-BN2-1-14-V			14			55			4.45	14.66	15.15	15.68	16.25	17.53	●
SPM200-BN2-1-16-V			16			55			4.03	16.73	17.29	17.9	18.55	20.01	●
SPM200-BN2-1-18-V			18			60			3.69	18.79	19.43	20.11	20.85	22.5	●
SPM200-BN2-1-20-V			20			60			3.4	20.86	21.57	22.33	23.15	24.99	●
SPM200-BN2-1.1-2-V	1.1	0.55	2	0.88	1.06	50	4	4	11.61	2.11	2.22	2.32	2.42	2.6	●
SPM200-BN2-1.1-4-V			4						9.09	4.24	4.43	4.59	4.74	5.08	●
SPM200-BN2-1.1-6-V			6						7.47	6.34	6.59	6.81	7.04	7.57	●
SPM200-BN2-1.1-8-V			8						6.34	8.43	8.73	9.03	9.34	10.06	●
SPM200-BN2-1.1-10-V			10						5.5	10.51	10.87	11.24	11.64	12.54	●
SPM200-BN2-1.2-4-V	1.2	0.6	4	0.96	1.15	50	4	4	9.05	4.22	4.4	4.55	4.7	5.04	●
SPM200-BN2-1.2-8-V			8			6.25			8.41	8.7	8.99	9.3	10.01	●	
SPM200-BN2-1.2-10-V			10			5.41			10.49	10.84	11.21	11.6	12.5	●	
SPM200-BN2-1.2-12-V			12			4.77			12.56	12.97	13.42	13.9	14.98	●	
SPM200-BN2-1.4-8-V	1.4	0.7	8	1.12	1.34	50	4	4	6.04	8.38	8.66	8.95	9.26	9.96	●
SPM200-BN2-1.4-12-V			12			4.56			12.53	12.94	13.38	13.86	14.93	●	
SPM200-BN2-1.4-16-V			16			3.67			16.66	17.22	17.82	18.46	19.9	●	
SPM200-BN2-1.5-4-V	1.5	0.75	4	1.2	1.44	50	4	4	8.82	4.2	4.36	4.51	4.65	4.97	●
SPM200-BN2-1.5-6-V			6						7.08	6.29	6.52	6.73	6.95	7.46	●

● Stock ○ Available upon Order

R	Tol.
R ≤ 0.25	±0.003
R > 0.25	±0.005

(mm)

Cutting Parameters ※ P502

SPM200-BN2 NEW

2 Flute, Extended Neck-Ball Nose End Mill

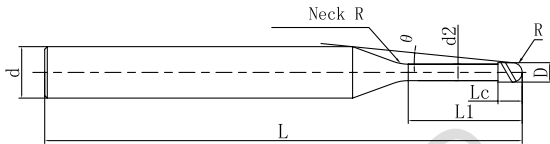

See page 97 for guidelines to icons

» Continue

Ordering Code	Mill Dia. D	R	Under Neck Length L1	Flute Length Lc	Neck Dia. d2	Overall Length L	Shank Dia. d	Neck R	Interference Angle θ	The effective under-neck length for the various draft angles					Stock
										0.5°	1°	1.5°	2°	3°	
SPM200-BN2-1.5-8-V	1.5	0.75	8	1.2	1.44	50	4	4	5.92	8.38	8.66	8.95	9.25	9.94	●
SPM200-BN2-1.5-10-V			10			50			5.08	10.46	10.8	11.16	11.55	12.43	●
SPM200-BN2-1.5-12-V			12			55			4.45	12.53	12.94	13.38	13.85	14.92	●
SPM200-BN2-1.5-14-V			14			55			3.96	14.6	15.08	15.6	16.15	17.4	●
SPM200-BN2-1.5-16-V			16			60			3.57	16.66	17.22	17.81	18.45	19.89	●
SPM200-BN2-1.5-18-V			18			60			3.25	18.73	19.36	20.03	20.75	22.38	●
SPM200-BN2-1.5-20-V			20			60			2.98	20.8	21.5	22.25	23.05	-	●
SPM200-BN2-1.6-8-V	1.6	0.8	8	1.28	1.54	50	4	4	5.8	8.38	8.66	8.94	9.25	9.93	●
SPM200-BN2-1.6-12-V			12			55			4.34	12.53	12.94	13.37	13.85	14.9	●
SPM200-BN2-1.6-16-V			16			55			3.47	16.66	17.21	17.81	18.44	19.88	●
SPM200-BN2-1.6-20-V			20			60			2.89	20.8	21.49	22.24	23.04	-	●
SPM200-BN2-1.8-8-V	1.8	0.9	8	1.44	1.73	50	4	4	5.55	8.36	8.63	8.91	9.21	9.88	●
SPM200-BN2-1.8-12-V			12			55			4.11	12.5	12.91	13.34	13.81	14.85	●
SPM200-BN2-1.8-16-V			16			55			3.26	16.64	17.19	17.77	18.41	19.83	●
SPM200-BN2-1.8-20-V			20			60			2.7	20.77	21.46	22.21	23.01	-	●
SPM200-BN2-2-3-V	2	1	3	1.6	1.92	50	4	4	9.72	3.11	3.22	3.32	3.42	3.62	●
SPM200-BN2-2-4-V			4			50			8.32	4.16	4.31	4.44	4.57	4.86	●
SPM200-BN2-2-6-V			6			50			6.46	6.26	6.46	6.66	6.87	7.35	●
SPM200-BN2-2-8-V			8			50			5.27	8.34	8.6	8.88	9.17	9.84	●
SPM200-BN2-2-10-V			10			50			4.46	10.41	10.74	11.09	11.47	12.32	●
SPM200-BN2-2-12-V			12			55			3.86	12.48	12.88	13.31	13.77	14.81	●
SPM200-BN2-2-13-V			13			55			3.62	13.51	13.95	14.42	14.92	16.05	●
SPM200-BN2-2-14-V			14			55			3.4	14.55	15.02	15.53	16.07	17.29	●
SPM200-BN2-2-16-V			16			55			3.04	16.62	17.16	17.74	18.37	19.78	●

● Stock ○ Available upon Order

R	Tol.
R ≤ 0.25	±0.003
R > 0.25	±0.005

(mm)

Cutting Parameters ※ P502

SPM200-BN2 NEW

2 Flute, Extended Neck-Ball Nose End Mill

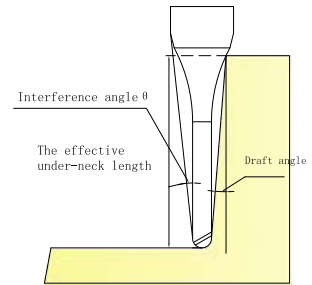
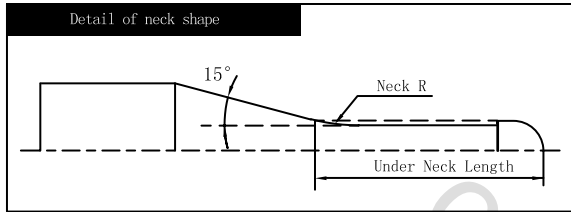

See page 97 for guidelines to icons

» Continue

Ordering Code	Mill Dia. D	R	Under Neck Length L1	Flute Length Lc	Neck Dia. d2	Overall Length L	Shank Dia. d	Neck R	Interference Angle θ	The effective under-neck length for the various draft angles					Stock
										0.5°	1°	1.5°	2°	3°	
SPM200-BN2-2-18-V	2	1	18	1.6	1.92	60	4	4	2.75	18.68	19.3	19.96	20.67	-	•
SPM200-BN2-2-20-V			20			2.51			20.75	21.44	22.18	22.97	-	•	
SPM200-BN2-2-22-V			22			2.31			22.82	23.58	24.39	25.27	-	•	
SPM200-BN2-2-25-V			25			2.06			25.92	26.79	27.72	28.72	-	•	
SPM200-BN2-2-30-V			30			1.75			31.09	32.14	33.26	-	-	•	
SPM200-BN2-2-35-V			35			1.52			36.26	37.48	38.8	-	-	•	
SPM200-BN2-2-40-V			40			1.34			41.42	42.83	-	-	-	•	
SPM200-BN2-2.5-6-V	2.5	1.25	6	2	2.4	50	4	4	5.62	6.22	6.41	6.6	6.8	7.25	•
SPM200-BN2-2.5-10-V			10			3.69			10.37	10.69	11.03	11.4	12.23	•	
SPM200-BN2-2.5-15-V			15			2.59			15.54	16.04	16.58	17.15	-	•	
SPM200-BN2-2.5-20-V			20			1.99			20.71	21.39	22.12	-	-	•	
SPM200-BN2-2.5-25-V			25			1.62			25.88	26.74	27.66	-	-	•	
SPM200-BN2-2.5-30-V			30			1.36			31.05	32.09	-	-	-	•	
SPM200-BN2-3-8-V	3	1.5	8	2.4	2.88	55	6	4	7.04	8.27	8.51	8.77	9.04	9.65	•
SPM200-BN2-3-10-V			10			6.05			10.34	10.65	10.98	11.34	12.14	•	
SPM200-BN2-3-13-V			13			5			13.44	13.86	14.31	14.79	15.87	•	
SPM200-BN2-3-16-V			16			4.26			16.55	17.07	17.63	18.24	19.6	•	
SPM200-BN2-3-20-V			20			3.56			20.68	21.35	22.07	22.84	24.57	•	
SPM200-BN2-3-25-V			25			2.95			25.85	26.7	27.61	28.59	-	•	
SPM200-BN2-3-30-V			30			2.52			31.02	32.05	33.15	34.34	-	•	
SPM200-BN2-3-35-V			35			2.2			36.19	37.39	38.69	40.08	-	•	
SPM200-BN2-3.5-15-V	3.5	1.75	15	2.8	3.36	60	6	4	3.99	15.49	15.96	16.48	17.03	18.27	•
SPM200-BN2-3.5-25-V			25			2.56			25.82	26.66	27.56	28.53	-	•	
SPM200-BN2-3.5-35-V			35			1.89			36.16	37.36	38.64	-	-	•	

• Stock ◦ Available upon Order

R	Tol.
R ≤ 0.25	±0.003
R > 0.25	±0.005

(mm)

Cutting Parameters ※ P502

SPM200-BN2 NEW

2 Flute, Extended Neck-Ball Nose End Mill

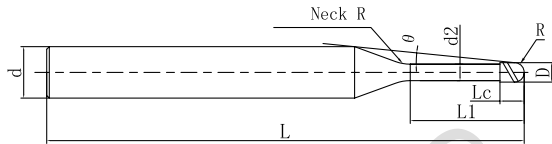

See page 97 for guidelines to icons

» Continue

Ordering Code	Mill Dia. D	R	Under Neck Length L1	Flute Length Lc	Neck Dia. d2	Overall Length L	Shank Dia. d	Neck R	Interference Angle θ	The effective under-neck length for the various draft angles					Stock
										0.5°	1°	1.5°	2°	3°	
SPM200-BN2-3.5-45-V	3.5	1.75	45	2.8	3.36	90	6	4	1.5	46.5	48.05	-	-	-	●
SPM200-BN2-4-10-V	4	2	10	3.2	3.86	55	6	4	4.86	10.31	10.6	10.91	11.24	11.99	●
SPM200-BN2-4-13-V			13			60			3.88	13.41	13.81	14.23	14.69	15.72	●
SPM200-BN2-4-16-V			16			60			3.23	16.51	17.02	17.56	18.14	19.45	●
SPM200-BN2-4-20-V			20			65			2.63	20.65	21.3	21.99	22.74	-	●
SPM200-BN2-4-25-V			25			70			2.14	25.81	26.64	27.53	28.49	-	●
SPM200-BN2-4-30-V			30			75			1.81	30.98	31.99	33.08	-	-	●
SPM200-BN2-4-35-V			35			80			1.56	36.15	37.34	38.62	-	-	●
SPM200-BN2-4-40-V			40			80			1.38	41.32	42.69	-	-	-	●
SPM200-BN2-4-45-V			45			90			1.23	46.49	48.04	-	-	-	●
SPM200-BN2-4-50-V			50			100			1.11	51.66	53.39	-	-	-	●
SPM200-BN2-5-20-V	5	2.5	20	4	4.85	65	6	4	1.48	20.62	21.25	-	-	-	●
SPM200-BN2-5-25-V			25			70			1.18	25.79	26.6	-	-	-	●
SPM200-BN2-5-30-V			30			75			0.98	30.96	-	-	-	-	●
SPM200-BN2-5-40-V			40			80			0.73	41.29	-	-	-	-	●
SPM200-BN2-6-12-V	6	3	12	6	5.85	60	6	-	-	-	-	-	-	-	●
SPM200-BN2-6-20-V			20			65			-	-	-	-	-	●	
SPM200-BN2-6-30-V			30			75			-	-	-	-	-	●	
SPM200-BN2-6-50-V			50			100			-	-	-	-	-	●	

● Stock ○ Available upon Order

R	Tol.
R ≤ 0.25	±0.003
R > 0.25	±0.005

(mm)



Cutting Parameters * P502

Case Studies

Stamping die Machining

Type	UP210-SL4-12045	 <p>Workpiece</p>  <p>Profiling</p>  <p>KY</p>  <p>GESAC</p> <p>Wear Condition of Cutting 1.5H</p>
Size	D12*45*100*d12	
Workpiece	H13 (45HRC)	
Cutting Speed	2600RPM(100m/min)	
Feed Rate	0.15mm/z(1600mm/min)	
Cutting Method	Side Milling	
Cutting Depth	ap=30mm , ae=0.05~0.2mm	
Cooling Method	Air Cooling	

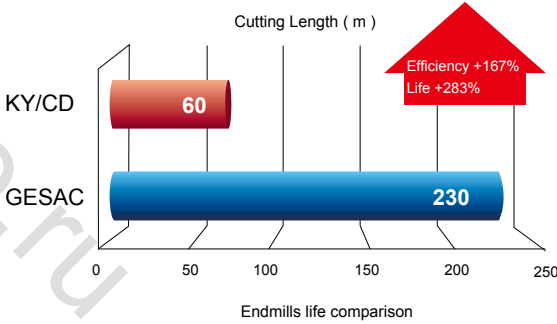
Type Block Contour Finishing

Type	SP210-S4-10025	 <p>Cutting Length (m)</p> <p>KY/CD: 60</p> <p>GESAC: 230</p> <p>Efficiency +167%</p> <p>Life +283%</p> <p>Endmills life comparison</p>
Size	D10*25*75*d10	
Workpiece	Q235A (HB200)	
Cutting Speed	5100RPM(160m/min)	
Feed Rate	0.078mm/z(1600mm/min)	
Cutting Method	Contour Finishing	
Cutting Depth	ap=5-12mm , ae=0.15mm	
Cooling Method	Emulsion	

Case Studies

Side Milling of Auto Parts

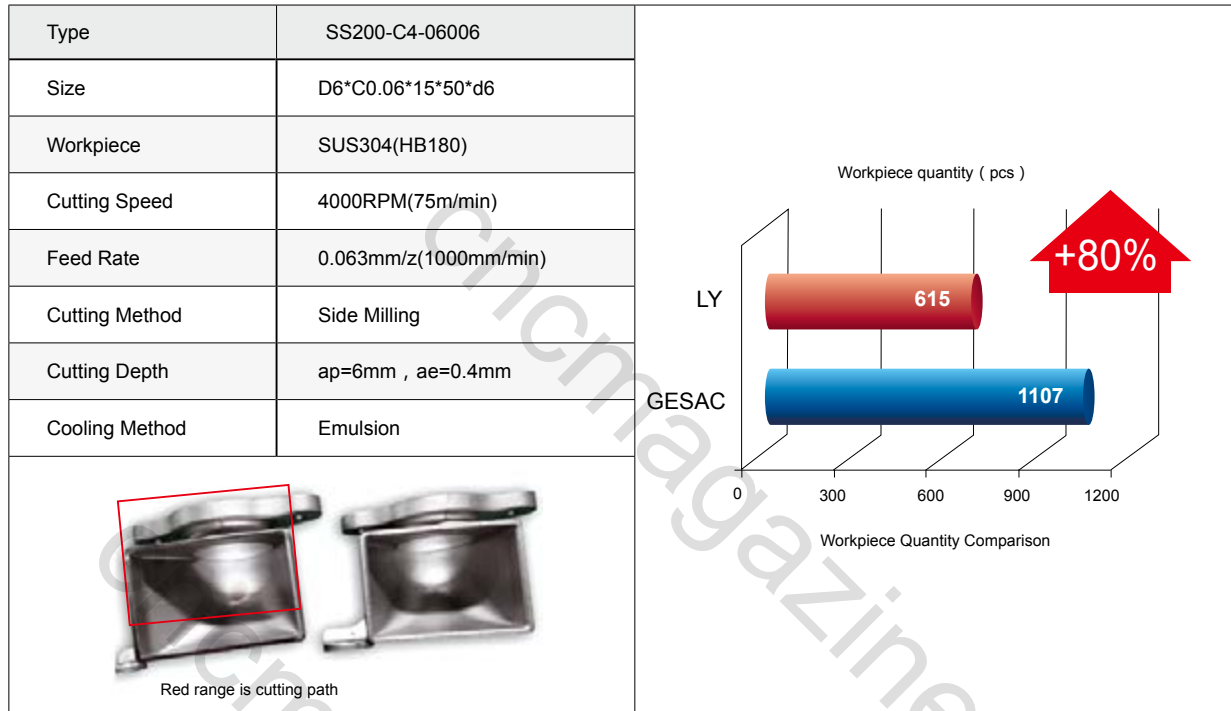

High efficiency milling cell phone cavity

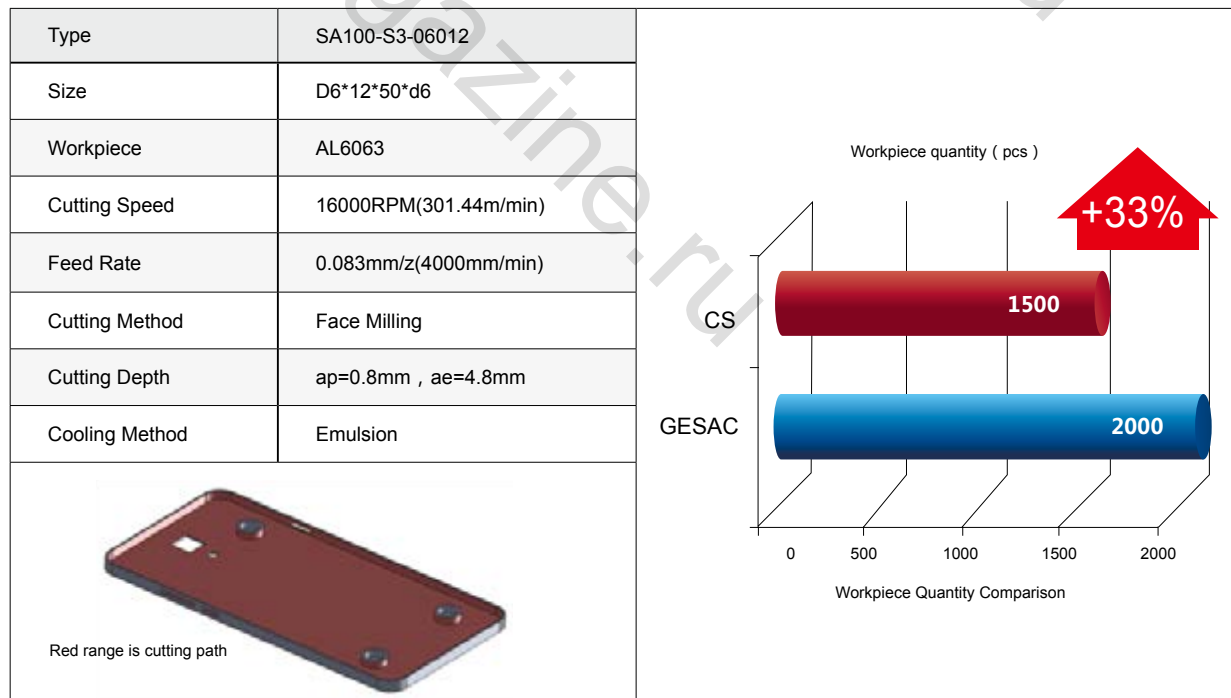

Case Studies

High Speed Cavity Cutting

Tool Name	SA360-RN2-20030	<p>Cutting time (H)</p> <p>CH: 33</p> <p>GESAC: 35</p> <p>+6%</p> <p>Endmills life comparison</p>
Tool Specification	D20*R3*30*60*100*d110*D19	
Material	AL7075(HB105)	
Cutting speed	22000RPM(1380m/min)	
Feed speed	0.15mm/z(6600mm/min)	
Cutting Method	Cavity Processing	
Cutting Area	ap=0.8mm , ae=4.8mm	
Cooling Method	ap=24mm , ae=1mm	
Cooling Method	Emulsion	

Graphite Electrode Machining

Type	SG200-RN4-10005	<p>Cutting time (H)</p> <p>KJ: 12</p> <p>GESAC: 15</p> <p>+25%</p> <p>Endmills life comparison</p>
Size	D10*R0.5*15*45*100*d10*D9.8	
Workpiece	Graphite	
Cutting Speed	9000RPM(280m/min)	
Feed Rate	0.11mm/z(4000mm/min)	
Cutting Method	Side Milling	
Cutting Depth	ap=0.15mm , ae=0.25mm	
Cooling Method	Air Cooling	

Case Studies

Convex plate of Case Clear-up machining

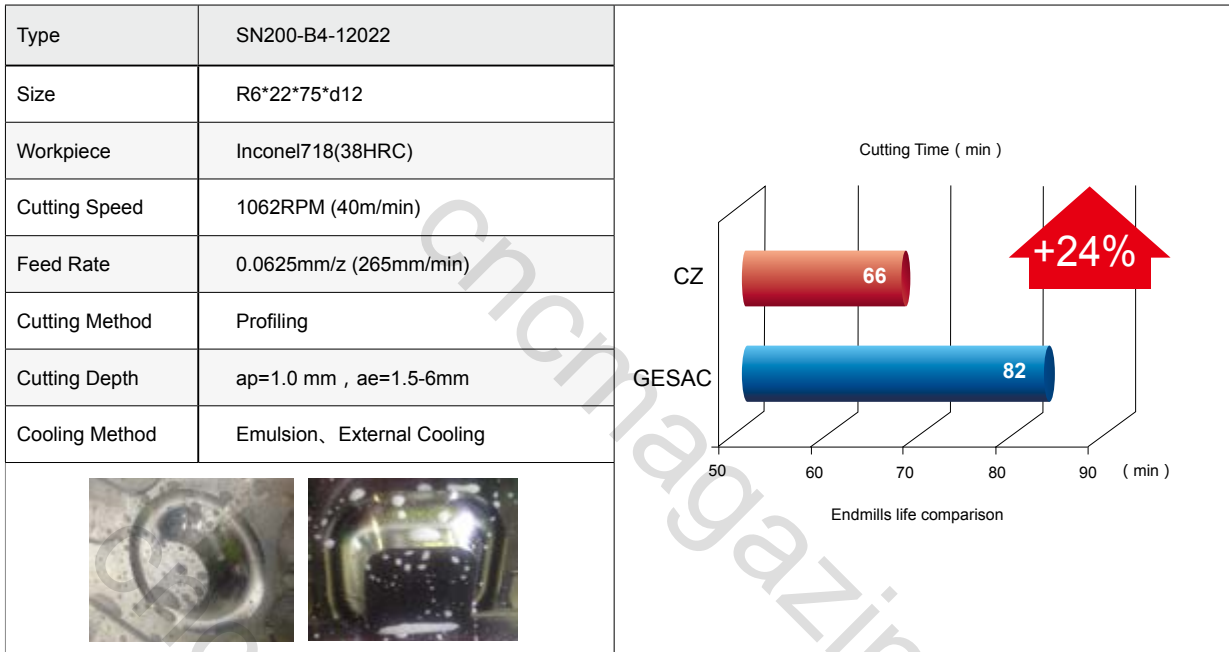

Semi-finishing TC4—ST200

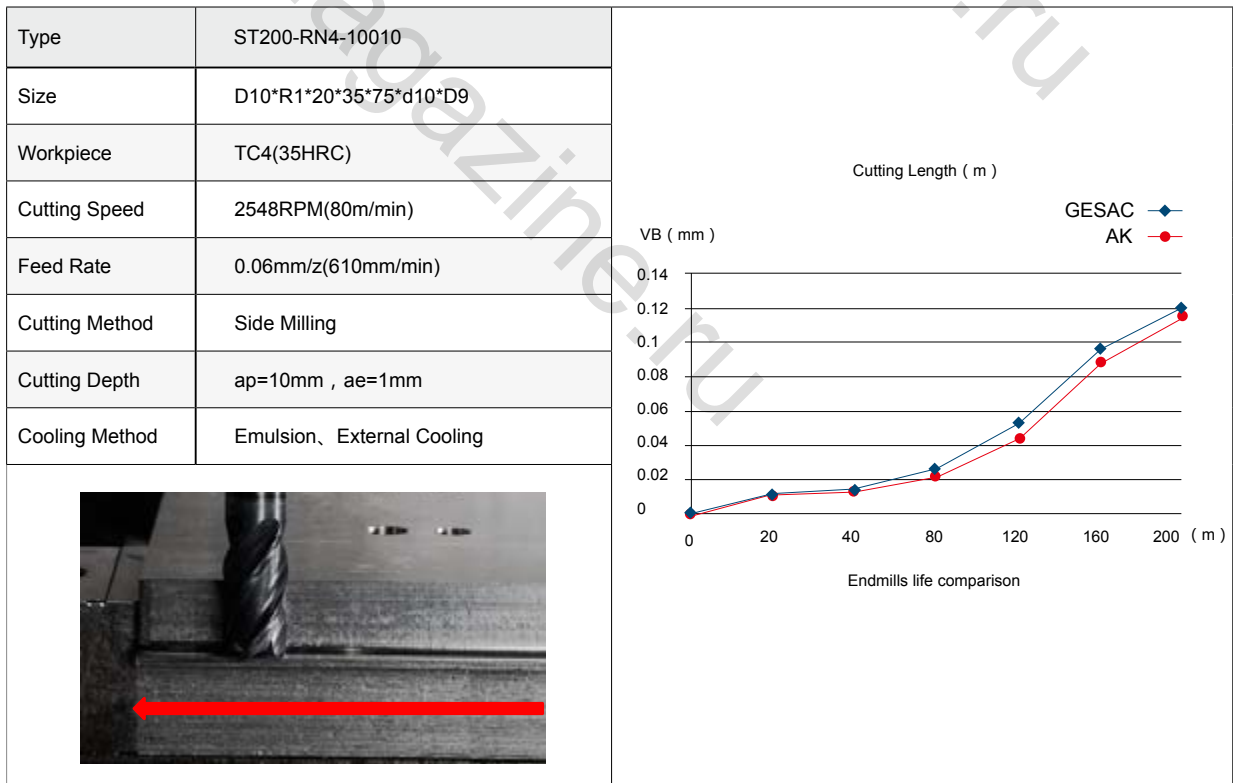

Case Studies

Face/Side Machining

Type	SH300-BH2-06009E-H	
Size	R3*9*75*d6	
Workpiece	SKD11(62HRC)	
Cutting Speed	10000RPM(188.4m/min)	
Feed Rate	0.06mm/z(1200mm/min)	
Cutting Method	Profiling	
Cutting Depth	ap=0.03mm ae=0.05mm	
Cooling Method	Oil Cooling	

Rough Machining

Type	FH200-R6-12008-H	<p>Machining Process</p>	<p>Chip Form</p>
Size	D12*R0.75*10*36*100*d12*D11.5		
Workpiece	SKD11(60HRC)	<p>GESAC</p>	<p>KJ</p>
Cutting Speed	1592RPM(60m/min)		
Feed Rate	0.2mm/z(1911mm/min)		
Cutting Method	Climb & Up Milling		
Cutting Depth	ap=0.25mm , ae=6mm		
Cooling Method	Air Cooling		

Case Studies

Finishing for High Precision Copper-Tungsten Electrode Mold for Inserts

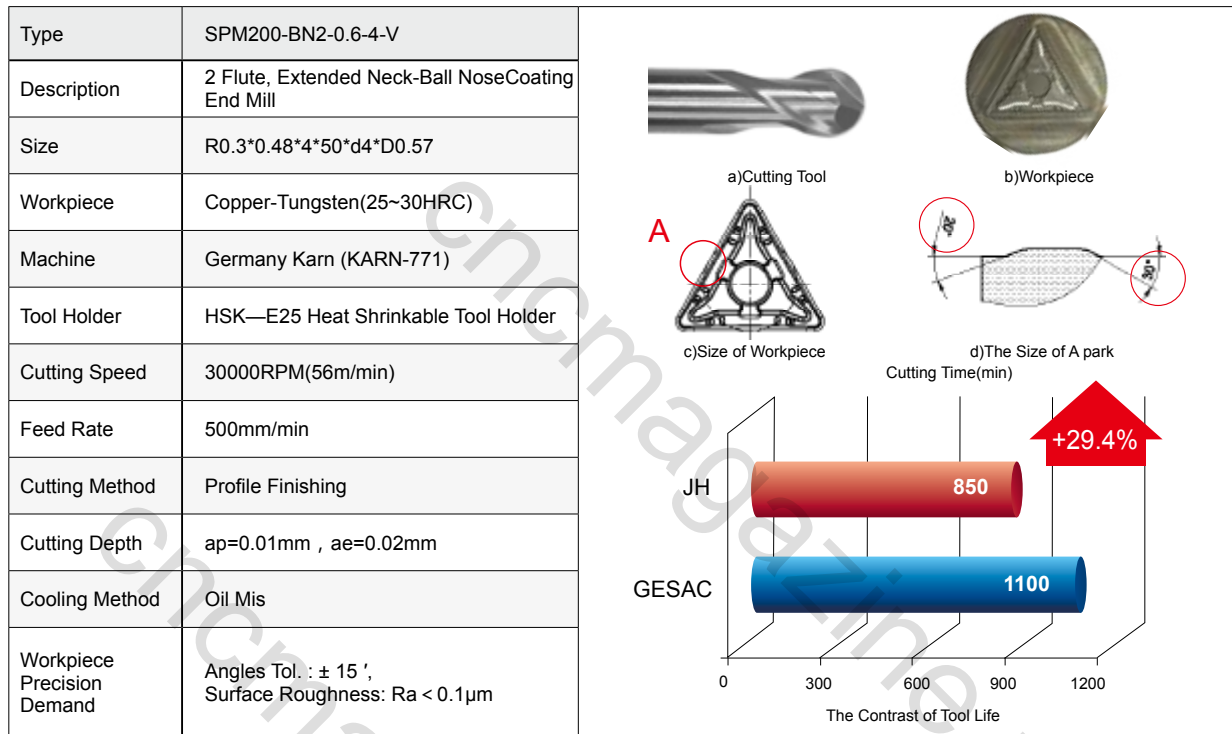

Recommended Cutting Data

UP100-SS2, S2, SL2, SH2, R2, RH2
For Steels, Cast Iron — Side Milling



Workpiece Material		Cutting Depth (mm)	Vc m/min	Tool Diameter (mm)	1	2	4	6	8	10	12	16	20
P	Carbon Steel, Alloy (< 35HRC)	ap 1D	170	n (min-1)	50000	27070	13540	9020	6770	5410	4510	3380	2710
		ae 0.12D		vf (mm/min)	1410	1080	890	810	840	810	770	740	650
	Alloy Steelqq (35-48HRC)	aqzsz	120	n (min-1)	38220	19110	9550	6370	4780	3820	3190	2390	1910
		ae 0.1D		vf (mm/min)	540	460	480	480	550	500	450	360	330
M	Stainless Steel	ap 1D	130	n (min-1)	41400	20700	10350	6900	5180	4140	3450	2590	2070
		ae 0.12D		vf (mm/min)	830	620	620	550	620	580	550	470	410
K	Gray Cast Iron Nodular Cast Iron (< 32HRC)	ap 1D	150	n (min-1)	47770	23890	11940	7960	5970	4780	3980	2990	2390
		ae 0.12D		vf (mm/min)	960	760	720	720	660	620	600	540	480
	High Alloy Cast Iron (35-45HRC)	ap 1D	130	n (min-1)	41400	20700	10350	6900	5180	4140	3450	2590	2070
		ae 0.1D		vf (mm/min)	660	540	500	550	520	500	480	410	370

UP100-S3
For Steels, Cast Iron — Side Milling



Workpiece Material		Cutting Depth (mm)	Vc m/min	Tool Diameter (mm)	1	2	4	6	8	10	12	16	20
P	Carbon Steel, Alloy (< 35HRC)	ap 1D	170	n (min-1)	50000	27070	13540	9020	6770	5410	4510	3380	2710
		ae 0.12D		vf (mm/min)	2110	1620	1340	1220	1260	1220	1150	1120	980
	Alloy Steelqq (35-48HRC)	ap 1D	120	n (min-1)	38220	19110	9550	6370	4780	3820	3190	2390	1910
		ae 0.1D		vf (mm/min)	800	690	720	730	830	750	670	540	490
M	Stainless Steel	ap 1D	130	n (min-1)	41400	20700	10350	6900	5180	4140	3450	2590	2070
		ae 0.12D		vf (mm/min)	1240	930	930	830	930	870	830	700	620
K	Gray Cast Iron Nodular Cast Iron (< 32HRC)	ap 1D	150	n (min-1)	47770	23890	11940	7960	5970	4780	3980	2990	2390
		ae 0.12D		vf (mm/min)	1430	1150	1080	1080	990	930	900	810	720
	High Alloy Cast Iron (35-45HRC)	ap 1D	130	n (min-1)	41400	20700	10350	6900	5180	4140	3450	2590	2070
		ae 0.1D		vf (mm/min)	990	810	750	830	780	750	730	620	560

1. Pls pay attention to use machine and holder with high rigidity .
2. Please adjust the speed, feed and cutting depth according to actual cutting conditons.
3. The milling conditions are for an end mill where the tool overhang length is less than 4*D (mill dia).When the tool overhang length is longer, please adjust the speed, feed and cutting depth.

Recommended Cutting Data

UP100-SS4, S4, SL4, SH4, R4, RH4
For Steels, Cast Iron — Side Milling



Workpiece Material		Cutting Depth (mm)	Vc m/min	Tool Diameter (mm)	1	2	4	6	8	10	12	16	20
P	Carbon Steel, Alloy (< 35HRC)	ap 1D	170	n (min-1)	50000	27070	13540	9020	6770	5410	4510	3380	2710
		ae 0.12D		vf (mm/min)	2820	2170	1790	1620	1680	1620	1530	1490	1300
	Alloy Steelqq (35-48HRC)	ap 1D	120	n (min-1)	38220	19110	9550	6370	4780	3820	3190	2390	1910
		ae 0.1D		vf (mm/min)	1070	920	960	970	1110	990	890	720	650
M	Stainless Steel	ap 1D	130	n (min-1)	41400	20700	10350	6900	5180	4140	3450	2590	2070
		ae 0.12D		vf (mm/min)	1660	1240	1240	1100	1240	1160	1100	930	830
K	Gray Cast Iron Nodular Cast Iron (< 32HRC)	ap 1D	150	n (min-1)	47770	23890	11940	7960	5970	4780	3980	2990	2390
		ae 0.12D		vf (mm/min)	1910	1530	1430	1430	1310	1240	1190	1080	960
	High Alloy Cast Iron (35-45HRC)	ap 1D	130	n (min-1)	41400	20700	10350	6900	5180	4140	3450	2590	2070
		ae 0.1D		vf (mm/min)	1330	1080	990	1100	1040	990	970	830	750

UP100-S6

For Steels, Cast Iron — Side Milling



Workpiece Material		Cutting Depth (mm)	Vc m/min	Tool Diameter (mm)	1	2	4	6	8	10	12	16	20
P	Carbon Steel, Alloy (< 35HRC)	ap 1D	170	n (min-1)	50000	27070	13540	9020	6770	5410	4510	3380	2710
		ae 0.12D		vf (mm/min)	4220	3250	2680	2440	2520	2440	2300	2230	1950
	Alloy Steelqq (35-48HRC)	ap 1D	120	n (min-1)	38220	19110	9550	6370	4780	3820	3190	2390	1910
		ae 0.1D		vf (mm/min)	1610	1380	1430	1450	1660	1490	1340	1080	980
M	Stainless Steel	ap 1D	130	n (min-1)	41400	20700	10350	6900	5180	4140	3450	2590	2070
		ae 0.12D		vf (mm/min)	2480	1860	1860	1660	1860	1740	1660	1400	1240
K	Gray Cast Iron Nodular Cast Iron (< 32HRC)	ap 1D	150	n (min-1)	47770	23890	11940	7960	5970	4780	3980	2990	2390
		ae 0.12D		vf (mm/min)	2870	2290	2150	2150	1970	1860	1790	1610	1430
	High Alloy Cast Iron (35-45HRC)	ap 1D	130	n (min-1)	41400	20700	10350	6900	5180	4140	3450	2590	2070
		ae 0.1D		vf (mm/min)	1990	1620	1490	1660	1550	1490	1450	1240	1120

1. Pls pay attention to use machine and holder with high rigidity .
2. Please adjust the speed,feed and cutting depth according to actual cutting conditons.
3. The milling conditions are for an end mill where the tool overhang length is less than 4*D (mill dia).When the tool overhang length is longer, please adjust the speed,feed and cutting depth.

Recommended Cutting Data

UP100-SS2, S2, SL2, SH2, R2, RH2
For Steels, Cast Iron — Slotting



Workpiece Material		Cutting Depth (mm)	Vc m/min	Tool Diameter (mm)	1	2	4	6	8	10	12	16	20
P	Carbon Steel, Alloy (< 35HRC)	ap 1D	80	n (min-1)	25480	12740	6370	4250	3190	2550	2120	1590	1270
				vf (mm/min)	510	510	510	430	380	360	340	380	380
M	Alloy Steelqq (35-48HRC)	ap 0.5D	60	n (min-1)	19110	9550	4780	3190	2390	1910	1590	1190	960
				vf (mm/min)	230	230	290	260	220	210	210	220	210
K	Stainless Steel	ap 0.3D	55	n (min-1)	17520	8760	4380	2920	2190	1750	1460	1100	880
				vf (mm/min)	250	180	150	190	190	190	190	160	150
K	Gray Cast Iron Nodular Cast Iron (< 32HRC)	ap 0.8D	55	n (min-1)	17520	8760	4380	2920	2190	1750	1460	1100	880
				vf (mm/min)	320	210	180	210	210	200	200	180	160
K	High Alloy Cast Iron (35-45HRC)	ap 0.5D	55	n (min-1)	17520	8760	4380	2920	2190	1750	1460	1100	880
				vf (mm/min)	250	180	150	190	190	190	190	160	150

UP100-S3
For Steels, Cast Iron — Slotting



Workpiece Material		Cutting Depth (mm)	Vc m/min	Tool Diameter (mm)	1	2	4	6	8	10	12	16	20
P	Carbon Steel, Alloy (< 35HRC)	ap 1D	80	n (min-1)	25480	12740	6370	4250	3190	2550	2120	1590	1270
				vf (mm/min)	760	760	760	640	570	540	510	570	570
M	Alloy Steelqq (35-48HRC)	ap 0.5D	60	n (min-1)	19110	9550	4780	3190	2390	1910	1590	1190	960
				vf (mm/min)	340	340	430	380	320	320	310	320	320
M	Stainless Steel	ap 0.3D	55	n (min-1)	17520	8760	4380	2920	2190	1750	1460	1100	880
				vf (mm/min)	370	260	220	290	290	280	280	250	220
K	Gray Cast Iron Nodular Cast Iron (< 32HRC)	ap 0.8D	55	n (min-1)	17520	8760	4380	2920	2190	1750	1460	1100	880
				vf (mm/min)	470	320	260	320	310	310	300	260	240
K	High Alloy Cast Iron (35-45HRC)	ap 0.5D	55	n (min-1)	17520	8760	4380	2920	2190	1750	1460	1100	880
				vf (mm/min)	370	260	220	290	290	280	280	250	220

1. Pls pay attention to use machine and holder with high rigidity .
2. Please adjust the speed, feed and cutting depth according to actual cutting conditons.
3. The milling conditions are for an end mill where the tool overhang length is less than 4*D (mill dia). When the tool overhang length is longer, please adjust the speed, feed and cutting depth.

Recommended Cutting Data

UP100-B2, BH2

For Steels, Cast Iron—Profiling



Workpiece Material		Cutting Depth (mm)	Vc m/min	Tool Diameter (mm)	1	2	4	6	8	10	12	16	20
P	Carbon Steel, Alloy (< 35HRC)	ap 0.2D	160	n (min ⁻¹)	50000	25480	12740	8490	6370	5100	4250	3190	2550
		ae 0.3D		vf (mm/min)	920	920	970	990	970	970	980	960	920
	Alloy Steelqq (35-48HRC)	ap 0.2D	120	n (min ⁻¹)	38220	19110	9550	6370	4780	3820	3190	2390	1910
		ae 0.25D		vf (mm/min)	460	460	540	590	620	610	640	570	570
M	Stainless Steel	ap 0.2D	110	n (min ⁻¹)	35030	17520	8760	5840	4380	3500	2920	2190	1750
		ae 0.2D		vf (mm/min)	490	530	560	610	610	600	610	570	560
K	Gray Cast Iron Nodular Cast Iron (< 32HRC)	ap 0.2D	140	n (min ⁻¹)	44590	22290	11150	7430	5570	4460	3720	2790	2230
		ae 0.2D		vf (mm/min)	620	670	710	770	780	760	780	730	710
	High Alloy Cast Iron (35-45HRC)	ap 0.3D	110	n (min ⁻¹)	35030	17520	8760	5840	4380	3500	2920	2190	1750
		ae 0.4D		vf (mm/min)	1400	1400	1400	1400	1400	1400	1400	1400	1400

UP100-B4

For Steels, Cast Iron—Profiling



Workpiece Material		Cutting Depth (mm)	Vc m/min	Tool Diameter (mm)	1	2	4	6	8	10	12	16	20
P	Carbon Steel, Alloy (< 35HRC)	ap 0.2D	160	n (min ⁻¹)	50000	25480	12740	8490	6370	5100	4250	3190	2550
		ae 0.3D		vf (mm/min)	1830	1830	1940	1970	1940	1940	1950	1910	1830
	Alloy Steelqq (35-48HRC)	ap 0.2D	120	n (min ⁻¹)	38220	19110	9550	6370	4780	3820	3190	2390	1910
		ae 0.25D		vf (mm/min)	920	920	1070	1170	1240	1220	1270	1150	1150
M	Stainless Steel	ap 0.2D	110	n (min ⁻¹)	35030	17520	8760	5840	4380	3500	2920	2190	1750
		ae 0.2D		vf (mm/min)	980	1050	1120	1210	1230	1190	1230	1140	1120
K	Gray Cast Iron Nodular Cast Iron (< 32HRC)	ap 0.2D	140	n (min ⁻¹)	44590	22290	11150	7430	5570	4460	3720	2790	2230
		ae 0.2D		vf (mm/min)	1250	1340	1430	1550	1560	1520	1560	1450	1430
	High Alloy Cast Iron (35-45HRC)	ap 0.3D	110	n (min ⁻¹)	35030	17520	8760	5840	4380	3500	2920	2190	1750
		ae 0.4D		vf (mm/min)	2800	2800	2800	2800	2800	2800	2800	2800	2800

1. Pls pay attention to use machine and holder with high rigidity .
2. Please adjust the speed, feed and cutting depth according to actual cutting conditons.
3. The milling conditions are for an end mill where the tool overhang length is less than 4*D (mill dia).When the tool overhang length is longer, please adjust the speed, feed and cutting depth.

Recommended Cutting Data

UP210-SS2, S2, SL2, SH2, R2, RH2

For Steels, Cast Iron —Side Milling



Workpiece Material		Cutting Depth (mm)	Vc m/min	Tool Diameter (mm)	3	4	6	8	10	12	16	20
P	Carbon Steel, Alloy (< 35HRC)	ap 1.5D	180	n (min-1)	19110	14330	9550	7170	5730	4780	3580	2870
		ae 0.15D		vf (mm/min)	1070	1030	920	930	920	860	860	860
	Alloy Steelqq (35-48HRC)	ap 1D	130	n (min-1)	13800	10350	6900	5180	4140	3450	2590	2070
		ae 0.12D		vf (mm/min)	610	580	550	620	560	500	410	370
M	Stainless Steel	ap 1.5D	130	n (min-1)	13800	10350	6900	5180	4140	3450	2590	2070
		ae 0.15D		vf (mm/min)	690	660	590	650	610	590	490	460
K	Gray Cast Iron Nodular Cast Iron (< 32HRC)	ap 1.5D	160	n (min-1)	16990	12740	8490	6370	5100	4250	3190	2550
		ae 0.15D		vf (mm/min)	850	820	820	750	700	680	610	560
	High Alloy Cast Iron (35-45HRC)	ap 1D	140	n (min-1)	14860	11150	7430	5570	4460	3720	2790	2230
		ae 0.12D		vf (mm/min)	650	670	670	620	580	560	500	460

UP210-S3

For Steels, Cast Iron —Side Milling



Workpiece Material		Cutting Depth (mm)	Vc m/min	Tool Diameter (mm)	3	4	6	8	10	12	16	20
P	Carbon Steel, Alloy (< 35HRC)	ap 1.5D	180	n (min-1)	19110	14330	9550	7170	5730	4780	3580	2870
		ae 0.15D		vf (mm/min)	1610	1550	1380	1400	1380	1290	1290	1290
	Alloy Steelqq (35-48HRC)	ap 1D	130	n (min-1)	13800	10350	6900	5180	4140	3450	2590	2070
		ae 0.12D		vf (mm/min)	910	870	830	930	850	760	620	560
M	Stainless Steel	ap 1.5D	130	n (min-1)	13800	10350	6900	5180	4140	3450	2590	2070
		ae 0.15D		vf (mm/min)	1040	990	890	980	920	880	740	680
K	Gray Cast Iron Nodular Cast Iron (< 32HRC)	ap 1.5D	160	n (min-1)	16990	12740	8490	6370	5100	4250	3190	2550
		ae 0.15D		vf (mm/min)	1270	1220	1220	1130	1060	1020	910	840
	High Alloy Cast Iron (35-45HRC)	ap 1D	140	n (min-1)	14860	11150	7430	5570	4460	3720	2790	2230
		ae 0.12D		vf (mm/min)	980	1000	1000	940	870	840	750	680

1. Pls pay attention to use machine and holder with high rigidity .

2. Please adjust the speed, feed and cutting depth according to actual cutting conditions.

3. The milling conditions are for an end mill where the tool overhang length is less than 4*D (mill dia).When the tool overhang length is longer, please adjust the speed, feed and cutting depth.

Recommended Cutting Data

UP210-SS4, S4, SL4, SH4, R4, RH4

For Steels, Cast Iron —Side Milling



Workpiece Material		Cutting Depth (mm)	Vc m/min	Tool Diameter (mm)	3	4	6	8	10	12	16	20
P	Carbon Steel, Alloy (< 35HRC)	ap 1.5D	180	n (min-1)	19110	14330	9550	7170	5730	4780	3580	2870
		ae 0.15D		vf (mm/min)	2140	2060	1830	1860	1830	1720	1720	1720
	Alloy Steelqq (35-48HRC)	ap 1D	130	n (min-1)	13800	10350	6900	5180	4140	3450	2590	2070
		ae 0.12D		vf (mm/min)	1210	1160	1100	1240	1130	1010	830	750
M	Stainless Steel	ap 1.5D	130	n (min-1)	13800	10350	6900	5180	4140	3450	2590	2070
		ae 0.15D		vf (mm/min)	1380	1330	1190	1300	1230	1170	980	910
K	Gray Cast Iron Nodular Cast Iron (< 32HRC)	ap 1.5D	160	n (min-1)	16990	12740	8490	6370	5100	4250	3190	2550
		ae 0.15D		vf (mm/min)	1700	1630	1630	1500	1410	1360	1210	1120
	High Alloy Cast Iron (35-45HRC)	ap 1D	140	n (min-1)	14860	11150	7430	5570	4460	3720	2790	2230
		ae 0.12D		vf (mm/min)	1310	1340	1340	1250	1160	1120	1000	910

UP210-S6

For Steels, Cast Iron —Side Milling



Workpiece Material		Cutting Depth (mm)	Vc m/min	Tool Diameter (mm)	3	4	6	8	10	12	16	20
P	Carbon Steel, Alloy (< 35HRC)	ap 1.5D	180	n (min-1)	19110	14330	9550	7170	5730	4780	3580	2870
		ae 0.15D		vf (mm/min)	3210	3100	2750	2800	2750	2580	2580	2580
	Alloy Steelqq (35-48HRC)	ap 1D	130	n (min-1)	13800	10350	6900	5180	4140	3450	2590	2070
		ae 0.12D		vf (mm/min)	1820	1740	1660	1860	1690	1510	1240	1120
M	Stainless Steel	ap 1.5D	130	n (min-1)	13800	10350	6900	5180	4140	3450	2590	2070
		ae 0.15D		vf (mm/min)	2070	1990	1780	1960	1840	1760	1480	1370
K	Gray Cast Iron Nodular Cast Iron (< 32HRC)	ap 1.5D	160	n (min-1)	16990	12740	8490	6370	5100	4250	3190	2550
		ae 0.15D		vf (mm/min)	2550	2450	2450	2260	2110	2040	1820	1680
	High Alloy Cast Iron (35-45HRC)	ap 1D	140	n (min-1)	14860	11150	7430	5570	4460	3720	2790	2230
		ae 0.12D		vf (mm/min)	1960	2010	2010	1870	1740	1670	1510	1360

1. Pls pay attention to use machine and holder with high rigidity .
2. Please adjust the speed,feed and cutting depth according to actual cutting conditons.
3. The milling conditions are for an end mill where the tool overhang length is less than 4*D (mill dia).When the tool overhang length is longer, please adjust the speed,feed and cutting depth.

Recommended Cutting Data

UP210-SS2, S2, SL2, SH2, R2, RH2

For Steels, Cast Iron— Slotting



Workpiece Material		Cutting Depth (mm)	Vc m/min	Tool Diameter (mm)	3	4	6	8	10	12	16	20
P	Carbon Steel, Alloy (< 35HRC)	ap 0.8D	80	n (min-1)	8490	6370	4250	3190	2550	2120	1590	1270
				vf (mm/min)	430	540	440	400	370	350	400	410
M	Alloy Steelqq (35-48HRC)	ap 0.3D	60	n (min-1)	6370	4780	3190	2390	1910	1590	1190	960
				vf (mm/min)	260	310	270	230	220	220	230	230
K	Stainless Steel	ap 0.3D	55	n (min-1)	5840	4380	2920	2190	1750	1460	1100	880
				vf (mm/min)	140	160	200	200	200	190	170	160
K	Gray Cast Iron Nodular Cast Iron (< 32HRC)	ap 0.5D	55	n (min-1)	5840	4380	2920	2190	1750	1460	1100	880
				vf (mm/min)	210	250	250	220	210	200	190	170
K	High Alloy Cast Iron (35-45HRC)	ap 0.3D	50	n (min-1)	5310	3980	2650	1990	1590	1330	1000	800
				vf (mm/min)	160	180	210	180	180	170	160	140

UP210-S3

For Steels, Cast Iron— Slotting



Workpiece Material		Cutting Depth (mm)	Vc m/min	Tool Diameter (mm)	3	4	6	8	10	12	16	20
P	Carbon Steel, Alloy (< 35HRC)	ap 0.8D	80	n (min-1)	8490	6370	4250	3190	2550	2120	1590	1270
				vf (mm/min)	640	800	660	590	550	520	600	610
M	Alloy Steelqq (35-48HRC)	ap 0.3D	60	n (min-1)	6370	4780	3190	2390	1910	1590	1190	960
				vf (mm/min)	380	460	400	340	330	330	340	340
K	Stainless Steel	ap 0.3D	55	n (min-1)	5840	4380	2920	2190	1750	1460	1100	880
				vf (mm/min)	210	240	310	300	290	290	260	240
K	Gray Cast Iron Nodular Cast Iron (< 32HRC)	ap 0.5D	55	n (min-1)	5840	4380	2920	2190	1750	1460	1100	880
				vf (mm/min)	320	370	380	330	320	310	280	250
K	High Alloy Cast Iron (35-45HRC)	ap 0.3D	50	n (min-1)	5310	3980	2650	1990	1590	1330	1000	800
				vf (mm/min)	240	280	320	270	260	260	240	220

1. Pls pay attention to use machine and holder with high rigidity .

2. Please adjust the speed, feed and cutting depth according to actual cutting conditons.

3. The milling conditions are for an end mill where the tool overhang length is less than 4*D (mill dia).When the tool overhang length is longer, please adjust the speed, feed and cutting depth.

Recommended Cutting Data

UP210-B2、BH2

For Steels, Cast Iron —Profiling



Workpiece Material		Cutting Depth (mm)	Vc m/min	Tool Diameter (mm)	4	5	6	7	8	9	10	11	12
P	Carbon Steel, Alloy (< 35HRC)	ap 0.2D	160	n (min-1)	12740	10190	8490	7280	6370	5660	5100	4630	4250
		ae 0.3D		vf (mm/min)	1020	1020	1020	1020	1020	1020	1020	1020	1020
	Alloy Steelqq (35-48HRC)	ap 0.15D	120	n (min-1)	9550	7640	6370	5460	4780	4250	3820	3470	3190
		ae 0.15D		vf (mm/min)	610	640	660	630	620	610	610	610	610
M	Stainless Steel	ap 0.2D	110	n (min-1)	8760	7010	5840	5010	4380	3890	3500	3190	2920
		ae 0.2D		vf (mm/min)	610	630	640	630	630	620	630	640	640
K	Gray Cast Iron Nodular Cast Iron (< 32HRC)	ap 0.2D	140	n (min-1)	11150	8920	7430	6370	5570	4950	4460	4050	3720
		ae 0.2D		vf (mm/min)	780	800	820	800	800	790	800	810	820
	High Alloy Cast Iron (35-45HRC)	ap 0.1D	120	n (min-1)	9550	7640	6370	5460	4780	4250	3820	3470	3190
		ae 0.1D		vf (mm/min)	610	640	660	660	670	650	650	660	670

UP210-B4

For Steels, Cast Iron —Profiling



Workpiece Material		Cutting Depth (mm)	Vc m/min	Tool Diameter (mm)	4	5	6	7	8	9	10	11	12
P	Carbon Steel, Alloy (< 35HRC)	ap 0.2D	160	n (min-1)	12740	10190	8490	7280	6370	5660	5100	4630	4250
		ae 0.3D		vf (mm/min)	2040	2040	2040	2040	2040	2040	2040	2040	2040
	Alloy Steelqq (35-48HRC)	ap 0.15D	120	n (min-1)	9550	7640	6370	5460	4780	4250	3820	3470	3190
		ae 0.15D		vf (mm/min)	1220	1280	1330	1270	1240	1220	1220	1210	1210
M	Stainless Steel	ap 0.2D	110	n (min-1)	8760	7010	5840	5010	4380	3890	3500	3190	2920
		ae 0.2D		vf (mm/min)	1230	1260	1290	1260	1260	1250	1260	1270	1290
K	Gray Cast Iron Nodular Cast Iron (< 32HRC)	ap 0.2D	140	n (min-1)	11150	8920	7430	6370	5570	4950	4460	4050	3720
		ae 0.2D		vf (mm/min)	1560	1610	1640	1610	1610	1590	1610	1620	1640
	High Alloy Cast Iron (35-45HRC)	ap 0.1D	120	n (min-1)	9550	7640	6370	5460	4780	4250	3820	3470	3190
		ae 0.1D		vf (mm/min)	1220	1280	1330	1310	1340	1310	1300	1320	1340

1. Pls pay attention to use machine and holder with high rigidity .
2. Please adjust the speed, feed and cutting depth according to actual cutting conditons.
3. The milling conditions are for an end mill where the tool overhang length is less than 4*D (mill dia).When the tool overhang length is longer, please adjust the speed, feed and cutting depth.

Recommended Cutting Data

SP210-S3、C3

For Steels, Cast Iron — Side Milling



Workpiece Material		Cutting Depth (mm)	Vc m/min	Tool Diameter (mm)	3	4	6	8	10	12	16	20
P	Carbon Steel, Alloy (< 35HRC)	ap 1.5D	200	n (min-1)	21230	15920	10620	7960	6370	5310	3980	3190
		ae 0.15D		vf (mm/min)	2040	1960	1690	1670	1620	1590	1490	1480
	Alloy Steelqq (35-48HRC)	ap 1D	150	n (min-1)	15920	11940	7960	5970	4780	3980	2990	2390
		ae 0.12D		vf (mm/min)	1290	1180	1080	1160	1050	930	760	680
M	Stainless Steel	ap 1.5D	150	n (min-1)	15920	11940	7960	5970	4780	3980	2990	2390
		ae 0.15D		vf (mm/min)	1580	1330	1150	1220	1130	1080	900	820
K	Gray Cast Iron Nodular Cast Iron (< 32HRC)	ap 1.5D	170	n (min-1)	18050	13540	9020	6770	5410	4510	3380	2710
		ae 0.15D		vf (mm/min)	1620	1500	1440	1300	1200	1150	1020	930
	High Alloy Cast Iron (35-45HRC)	ap 1D	150	n (min-1)	15920	11940	7960	5970	4780	3980	2990	2390
		ae 0.12D		vf (mm/min)	1290	1250	1190	1090	1000	960	850	770

SP210-C4、CN4、R4、S4

For Steels, Cast Iron — Side Milling



Workpiece Material		Cutting Depth (mm)	Vc m/min	Tool Diameter (mm)	3	4	6	8	10	12	16	20
P	Carbon Steel, Alloy (< 35HRC)	ap 1.5D	200	n (min-1)	21230	15920	10620	7960	6370	5310	3980	3190
		ae 0.15D		vf (mm/min)	2720	2610	2250	2230	2170	2120	1990	1980
	Alloy Steelqq (35-48HRC)	ap 1D	150	n (min-1)	15920	11940	7960	5970	4780	3980	2990	2390
		ae 0.12D		vf (mm/min)	1720	1580	1430	1550	1400	1240	1020	910
M	Stainless Steel	ap 1.5D	150	n (min-1)	15920	11940	7960	5970	4780	3980	2990	2390
		ae 0.15D		vf (mm/min)	2100	1770	1530	1620	1510	1430	1190	1100
K	Gray Cast Iron Nodular Cast Iron (< 32HRC)	ap 1.5D	170	n (min-1)	18050	13540	9020	6770	5410	4510	3380	2710
		ae 0.15D		vf (mm/min)	2170	2000	1910	1730	1600	1530	1350	1250
	High Alloy Cast Iron (35-45HRC)	ap 1D	150	n (min-1)	15920	11940	7960	5970	4780	3980	2990	2390
		ae 0.12D		vf (mm/min)	1720	1670	1590	1460	1340	1270	1140	1020

1、Pls pay attention to use machine and holder with high rigidity .

2、Please adjust the speed, feed and cutting depth according to actual cutting conditions.

3、The milling conditions are for an end mill where the tool overhang length is less than 4*D (mill dia) .When the tool overhang length is longer, please adjust the speed, feed and cutting depth.

Recommended Cutting Data

SP210-S3、C3

For Steels, Cast Iron — Side Milling



Workpiece Material		Cutting Depth (mm)	Vc m/min	Tool Diameter (mm)	3	4	6	8	10	12	16	20
P	Carbon Steel, Alloy (< 35HRC)	ap 1D	80	n (min-1)	8490	6370	4250	3190	2550	2120	1590	1270
				vf (mm/min)	790	920	730	640	590	570	640	650
M	Alloy Steelqq (35-48HRC)	ap 0.5D	60	n (min-1)	6370	4780	3190	2390	1910	1590	1190	960
				vf (mm/min)	500	550	450	370	360	360	370	370
K	Stainless Steel	ap 0.3D	55	n (min-1)	5840	4380	2920	2190	1750	1460	1100	880
				vf (mm/min)	320	320	350	340	320	320	280	260
K	Gray Cast Iron Nodular Cast Iron (< 32HRC)	ap 0.8D	55	n (min-1)	5840	4380	2920	2190	1750	1460	1100	880
				vf (mm/min)	420	450	420	360	340	340	310	280
K	High Alloy Cast Iron (35-45HRC)	ap 0.5D	50	n (min-1)	5310	3980	2650	1990	1590	1330	1000	800
				vf (mm/min)	330	350	360	300	290	290	260	240

SP210-C4、CN4、R4、S4

For Steels, Cast Iron — Side Milling



Workpiece Material		Cutting Depth (mm)	Vc m/min	Tool Diameter (mm)	3	4	6	8	10	12	16	20
P	Carbon Steel, Alloy (< 35HRC)	ap 1D	80	n (min-1)	8490	6370	4250	3190	2550	2120	1590	1270
				vf (mm/min)	1050	1220	970	850	790	760	850	870
M	Alloy Steelqq (35-48HRC)	ap 0.5D	60	n (min-1)	6370	4780	3190	2390	1910	1590	1190	960
				vf (mm/min)	660	730	600	500	470	480	490	500
M	Stainless Steel	ap 0.3D	55	n (min-1)	5840	4380	2920	2190	1750	1460	1100	880
				vf (mm/min)	420	420	470	450	430	430	380	350
K	Gray Cast Iron Nodular Cast Iron (< 32HRC)	ap 0.8D	55	n (min-1)	5840	4380	2920	2190	1750	1460	1100	880
				vf (mm/min)	560	600	560	480	460	450	410	370
K	High Alloy Cast Iron (35-45HRC)	ap 0.5D	50	n (min-1)	5310	3980	2650	1990	1590	1330	1000	800
				vf (mm/min)	450	460	480	400	380	380	350	320

- 1、Pls pay attention to use machine and holder with high rigidity .
- 2、Please adjust the speed,feed and cutting depth according to actual cutting conditons.
- 3、The milling conditions are for an end mill where the tool overhang length is less than 4*D (mill dia).When the tool overhang length is longer, please adjust the speed,feed and cutting depth.

Recommended Cutting Data

SP210-B2、BH2

For Steels, Cast Iron——Profiling



Workpiece Material		Cutting Depth (mm)	Vc m/min	Tool Diameter (mm)	1	2	3	4	6	8	10	12
P	Carbon Steel, Alloy (< 35HRC)	ap 0.04D	220	n (min-1)	50000	35030	23360	17520	11680	8760	7010	5840
		ae 0.04D		vf (mm/min)	2800	2800	2800	2800	2800	2800	2800	2800
	Alloy Steelqq (35-48HRC)	ap 0.02D	180	n (min-1)	50000	28660	19110	14330	9550	7170	5730	4780
		ae 0.02D		vf (mm/min)	1950	2010	1990	2010	2010	2010	2000	2000
M	Stainless Steel	ap 0.04D	220	n (min-1)	50000	35030	23360	17520	11680	8760	7010	5840
		ae 0.04D		vf (mm/min)	2520	2450	2570	2630	2570	2540	2520	2530
K	Gray Cast Iron Nodular Cast Iron (< 32HRC)	ap 0.04D	220	n (min-1)	50000	35030	23360	17520	11680	8760	7010	5840
		ae 0.04D		vf (mm/min)	2520	2450	2570	2630	2570	2540	2520	2530
	High Alloy Cast Iron (35-45HRC)	ap 0.04D	220	n (min-1)	50000	35030	23360	17520	11680	8760	7010	5840
		ae 0.04D		vf (mm/min)	2380	2450	2430	2450	2450	2450	2440	2440

UPR100-S4

For Steels, Cast Iron——Side Milling



Workpiece Material		Cutting Depth (mm)	Vc m/min	Tool Diameter (mm)	6	8	10	12	16	20
P	Carbon Steel, Alloy (< 35HRC)	ap 1D	140	n (min-1)	7430	5570	4460	3720	2790	2230
		ae 0.2D		vf (mm/min)	1250	1250	1250	1190	1120	980
	Alloy Steelqq (35-48HRC)	ap 1D	110	n (min-1)	5840	4380	3500	2920	2190	1750
		ae 0.12D		vf (mm/min)	700	700	700	700	700	630
M	Stainless Steel	ap 1D	130	n (min-1)	6900	5180	4140	3450	2590	2070
		ae 0.2D		vf (mm/min)	990	990	990	990	930	830
K	Gray Cast Iron Nodular Cast Iron (< 32HRC)	ap 1D	140	n (min-1)	7430	5570	4460	3720	2790	2230
		ae 0.2D		vf (mm/min)	1250	1250	1250	1190	1120	980
	High Alloy Cast Iron (35-45HRC)	ap 1D	130	n (min-1)	6900	5180	4140	3450	2590	2070
		ae 0.12D		vf (mm/min)	990	990	990	990	930	830
N	Wrought Aluminum Alloys Cast Aluminum Alloys (Si≤12%)	ap 1.5D	350	n (min-1)	18580	13930	11150	9290	6970	5570
		ae 0.3D		vf (mm/min)	4460	4460	4460	4460	4460	4460
	Copper Alloys (<200HB)	ap 1.5D	300	n (min-1)	15920	11940	9550	7960	5970	4780
		ae 0.3D		vf (mm/min)	3500	3340	3440	3190	3110	3060

- 1、Pls pay attention to use machine and holder with high rigidity .
- 2、Please adjust the speed,feed and cutting depth according to actual cutting conditons.
- 3、The milling conditions are for an end mill where the tool overhang length is less than 4*D (mill dia).When the tool overhang length is longer, please adjust the speed,feed and cutting depth.

Recommended Cutting Data

UPR100-S4

For Steels, Cast Iron—Slotting



Workpiece Material		Cutting Depth (mm)	Vc m/min	Tool Diameter (mm)	6	8	10	12	16	20
P	Carbon Steel, Alloy (< 35HRC)	ap 1D	80	n (min-1)	4250	3190	2550	2120	1590	1270
				vf (mm/min)	760	700	660	640	700	710
M	Alloy Steelqq (35-48HRC)	ap 0.5D	60	n (min-1)	3190	2390	1910	1590	1190	960
				vf (mm/min)	380	380	380	380	330	310
K	Stainless Steel	ap 0.5D	55	n (min-1)	2920	2190	1750	1460	1100	880
				vf (mm/min)	350	350	350	350	310	280
K	Gray Cast Iron Nodular Cast Iron (< 32HRC)	ap 1D	55	n (min-1)	2920	2190	1750	1460	1100	880
				vf (mm/min)	370	370	360	350	310	280
N	High Alloy Cast Iron (35-45HRC)	ap 0.8D	55	n (min-1)	2920	2190	1750	1460	1100	880
				vf (mm/min)	350	350	350	320	290	260
N	Wrought Aluminum Alloys Cast Aluminum Alloys (Si≤12%)	ap 1D	180	n (min-1)	9550	7170	5730	4780	3580	2870
				vf (mm/min)	1910	1720	1610	1530	1860	1830
N	Copper Alloys (<200HB)	ap 1D	160	n (min-1)	8490	6370	5100	4250	3190	2550
				vf (mm/min)	1530	1400	1330	1270	1400	1430

- 1、Pls pay attention to use machine and holder with high rigidity .
- 2、Please adjust the speed,feed and cutting depth according to actual cutting conditons.
- 3、The milling conditions are for an end mill where the tool overhang length is less than 4*D (mill dia).When the tool overhang length is longer, please adjust the speed,feed and cutting depth.

Recommended Cutting Data

UPN210-S4

For Steels, Cast Iron—Side Milling



Workpiece Material		Cutting Depth (mm)	Vc m/min	Tool Diameter (mm)	6	8	10	12	16	20
P	Carbon Steel, Alloy (< 35HRC)	ap 1.5D	130	n (min-1)	6900	5180	4140	3450	2590	2070
		ae 0.3D		vf (mm/min)	990	990	990	990	930	830
	Alloy Steelqq (35-48HRC)	ap 1D	110	n (min-1)	5840	4380	3500	2920	2190	1750
		ae 0.25D		vf (mm/min)	580	610	630	640	525	490
M	Stainless Steel	ap 1.5D	130	n (min-1)	6900	5180	4140	3450	2590	2070
		ae 0.3D		vf (mm/min)	280	310	330	350	310	290
K	Gray Cast Iron Nodular Cast Iron (< 32HRC)	ap 1.5D	130	n (min-1)	6900	5180	4140	3450	2590	2070
		ae 0.3D		vf (mm/min)	990	990	990	990	930	830
	High Alloy Cast Iron (35-45HRC)	ap 1D	110	n (min-1)	5840	4380	3500	2920	2190	1750
		ae 0.25D		vf (mm/min)	580	610	630	640	525	490
H	Alloy Steel Hardened Steel (< 55HRC)	ap 1D	90	n (min-1)	4780	3580	2870	2390	1790	1430
		ae 0.125D		vf (mm/min)	480	430	400	380	360	345

1. Pls pay attention to use machine and holder with high rigidity .
2. Please adjust the speed, feed and cutting depth according to actual cutting conditons.
3. The milling conditions are for an end mill where the tool overhang length is less than 4*D (mill dia).When the tool overhang length is longer, please adjust the speed, feed and cutting depth.

Recommended Cutting Data

UPN210-S4

For Steels, Cast Iron—Slotting



Workpiece Material		Cutting Depth (mm)	Vc m/min	Tool Diameter (mm)	6	8	10	12	16	20
P	Carbon Steel, Alloy (< 35HRC)	ap 0.8D	120	n (min-1)	6370	4780	3820	3190	2390	1910
				vf (mm/min)	640	630	610	640	570	535
M	Alloy Steel qq (35-48HRC)	ap 0.5D	100	n (min-1)	5310	4000	3190	2650	1990	1590
				vf (mm/min)	430	400	450	425	360	320
K	Stainless Steel	ap 0.8D	100	n (min-1)	5310	3980	3190	2655	1990	1600
				vf (mm/min)	150	160	190	210	200	190
K	Gray Cast Iron Nodular Cast Iron (< 32HRC)	ap 0.8D	120	n (min-1)	6370	4780	3820	3190	2390	1910
				vf (mm/min)	640	630	610	640	570	535
K	High Alloy Cast Iron (35-45HRC)	ap 0.5D	100	n (min-1)	5310	4000	3190	2650	1990	1590
				vf (mm/min)	430	400	450	425	360	320

1、Pls pay attention to use machine and holder with high rigidity .

2、Please adjust the speed,feed and cutting depth according to actual cutting conditons.

3、The milling conditions are for an end mill where the tool overhang length is less than 4*D (mill dia).When the tool overhang length is longer, please adjust the speed,feed and cutting depth.

Recommended Cutting Data

UPM100-SN2

For Steels, Cast Iron—Side Milling



Workpiece Material		Cutting Depth (mm)	Vc m/min	Tool Diameter (mm)	0.8	0.9	1	1.2	1.4	1.6	1.8	2
P	Carbon Steel, Alloy (< 35HRC)	ap 0.5D	90	n (min-1)	35830	31850	28660	23890	20470	17910	15920	14330
		ae 0.05D		vf (mm/min)	1150	1150	1150	1100	1110	1070	1110	1150
	Alloy Steelqq (35-48HRC)	ap 0.5D	70	n (min-1)	27870	24770	22290	18580	15920	13930	12380	11150
		ae 0.05D		vf (mm/min)	840	840	850	820	800	780	820	850
M	Stainless Steel	ap 0.5D	60	n (min-1)	23890	21230	19110	15920	13650	11940	10620	9550
		ae 0.03D		vf (mm/min)	760	760	760	730	740	720	740	760
K	Gray Cast Iron Nodular Cast Iron (< 32HRC)	ap 0.5D	90	n (min-1)	35830	31850	28660	23890	20470	17910	15920	14330
		ae 0.05D		vf (mm/min)	1150	1150	1150	1100	1110	1070	1110	1150
	High Alloy Cast Iron (35-45HRC)	ap 0.5D	80	n (min-1)	31850	28310	25480	21230	18200	15920	14150	12740
		ae 0.03D		vf (mm/min)	830	850	820	760	800	860	910	940

UPM100-SN2

For Steels, Cast Iron—Slotting



Workpiece Material		Cutting Depth (mm)	Vc m/min	Tool Diameter (mm)	0.8	0.9	1	1.2	1.4	1.6	1.8	2
P	Carbon Steel, Alloy (< 35HRC)	ap 0.3D	50	n (min-1)	19900	17690	15920	13270	11370	9950	8850	7960
				vf (mm/min)	400	390	380	370	390	400	410	400
	Alloy Steelqq (35-48HRC)	ap 0.1D	40	n (min-1)	15920	14150	12740	10620	9100	7960	7080	6370
				vf (mm/min)	250	250	250	250	270	290	300	290
M	Stainless Steel	ap 0.2D	40	n (min-1)	13930	12380	11150	9290	7960	6970	6190	5570
				vf (mm/min)	250	250	250	240	250	260	270	270
K	Gray Cast Iron Nodular Cast Iron (< 32HRC)	ap 0.3D	40	n (min-1)	15920	14150	12740	10620	9100	7960	7080	6370
				vf (mm/min)	320	310	310	300	310	320	330	320
	High Alloy Cast Iron (35-45HRC)	ap 0.2D	30	n (min-1)	11940	10620	9550	7960	6820	5970	5310	4780
				vf (mm/min)	210	210	210	210	220	230	230	230

1. Maximum T.I.R. in when tool is chucked is 0.01mm(0.01mm maximum recommended).
2. Pls pay attention to use machine and holder with high rigidity .
3. Please adjust the speed,feed and cutting depth according to actual cutting conditons.
4. The milling conditions are for an end mill where the tool overhang length is less than 4*D (mill dia).When the tool overhang length is longer, please adjust the speed,feed and cutting depth.
5. If the rpm of the machine is low,lower the feed rate also to put the rpm and feed rate in the same ratio.

Recommended Cutting Data

UPM100-BN2

For Steels, Cast Iron—Profiling



Workpiece Material		Cutting Depth (mm)	Vc m/min	Tool Diameter (mm)	0.6	0.8	1	1.2	1.6	2
P	Carbon Steel, Alloy (< 35HRC)	ap 0.02D	80	n (min-1)	42460	31850	25480	21230	15920	12740
		ae 0.02D		vf (mm/min)	1440	1460	1430	1490	1430	1400
	Alloy Steelqq (35-48HRC)	ap 0.01D	70	n (min-1)	37150	27870	22290	18580	13930	11150
		ae 0.01D		vf (mm/min)	1190	1170	1160	1190	1170	1160
M	Stainless Steel	ap 0.02D	70	n (min-1)	34500	25880	20700	17250	12940	10350
		ae 0.02D		vf (mm/min)	1170	1190	1160	1210	1160	1140
K	Gray Cast Iron Nodular Cast Iron (< 32HRC)	ap 0.02D	80	n (min-1)	42460	31850	25480	21230	15920	12740
		ae 0.02D		vf (mm/min)	1440	1460	1430	1490	1430	1400
	High Alloy Cast Iron (35-45HRC)	ap 0.02D	70	n (min-1)	37150	27870	22290	18580	13930	11150
		ae 0.02D		vf (mm/min)	1190	1170	1160	1190	1170	1160

- 1、Maximum T.I.R. in when tool is chucked is 0.01mm(0.01mm maximum recommended).
- 2、Pls pay attention to use machine and holder with high rigidity .
- 3、Please adjust the speed,feed and cutting depth according to actual cutting conditons.
- 4、The milling conditions are for an end mill where the tool overhang length is less than 4*D (mill dia).When the tool overhang length is longer, please adjust the speed,feed and cutting depth.
- 5、If the rpm of the machine is low,lower the feed rate also to put the rpm and feed rate in the same ratio.

Recommended Cutting Data

US200-S2、R2

Stainless Steels — Side Milling



Workpiece Material		Cutting Depth (mm)	Vc m/min	Tool Diameter (mm)	1	2	4	6	8	10	12	16	20
M	Stainless Steel	ap 1D	100 (80-120)	n (min-1)	25000	15900	7960	5300	3980	3180	2650	1990	1590
		ae 0.1D		vf (mm/min)	220	254	340	340	365	330	300	245	230

US200-S2、R2

Stainless Steels — Slotting



Workpiece Material		Cutting Depth (mm)	Vc m/min	Tool Diameter (mm)	1	2	4	6	8	10	12	16	20
M	Stainless Steel	ap 0.1D	45 (35-55)	n (min-1)	14330	7165	3580	2390	1790	1430	1195	895	715
		ae 1D		vf (mm/min)	200	140	120	155	155	155	155	135	120

US200-R3

Stainless Steels — Side Milling



Workpiece Material		Cutting Depth (mm)	Vc m/min	Tool Diameter (mm)	1	2	4	6	8	10	12	16	20
M	Stainless Steel	ap 1D	100 (80-120)	n (min-1)	25000	15900	7960	5300	3980	3180	2650	1990	1590
		ae 0.1D		vf (mm/min)	525	480	525	510	550	500	450	370	340

US200-R3

Stainless Steels — Slotting



Workpiece Material		Cutting Depth (mm)	Vc m/min	Tool Diameter (mm)	1	2	4	6	8	10	12	16	20
M	Stainless Steel	ap 0.1D	45 (35-55)	n (min-1)	14330	7165	3580	2390	1790	1430	1195	895	715
		ae 1D		vf (mm/min)	300	215	180	235	235	230	230	200	180

1. Pls pay attention to use machine and holder with high rigidity .
2. Please adjust the speed,feed and cutting depth according to actual cutting conditons.
3. The milling conditions are for an end mill where the tool overhang length is less than 4*D (mill dia).When the tool overhang length is longer, please adjust the speed,feed and cutting depth.

Recommended Cutting Data

US200-SS4、S4、SN4、R4
Stainless Steels — Side Milling



Workpiece Material		Cutting Depth (mm)	Vc m/min	Tool Diameter (mm)	1	2	4	6	8	10	12	16	20
M	Stainless Steels	ap 1D	100 (80-120)	$\frac{n}{(min-1)}$	25000	15900	7960	5300	3980	3180	2650	1990	1590
		ae 0.1D		$\frac{vf}{(mm/min)}$	700	635	700	680	730	660	600	490	460

US200-R4
Stainless Steels — Slotting



Workpiece Material		Cutting Depth (mm)	Vc m/min	Tool Diameter (mm)	1	2	4	6	8	10	12	16	20
M	Stainless Steels	ap 0.1D	45 (35-55)	$\frac{n}{(min-1)}$	14330	7165	3580	2390	1790	1430	1195	895	715
		ae 1D		$\frac{vf}{(mm/min)}$	400	280	240	310	310	310	310	270	240

US200-B2
Stainless Steels — Profiling



Workpiece Material		Cutting Depth (mm)	Vc m/min	Tool Diameter (mm)	1	2	4	6	8	10	12	16	20
M	Stainless Steels	ap 0.2D	100 (80-120)	$\frac{n}{(min-1)}$	25000	15900	7960	5300	3980	3180	2650	1990	1590
		ae 0.2D		$\frac{vf}{(mm/min)}$	525	480	510	550	560	540	560	520	510

US200-B4
Stainless Steels — Profiling



Workpiece Material		Cutting Depth (mm)	Vc m/min	Tool Diameter (mm)	1	2	4	6	8	10	12	16	20
M	Stainless Steels	ap 0.2D	100 (80-120)	$\frac{n}{(min-1)}$	25000	15900	7960	5300	3980	3180	2650	1990	1590
		ae 0.2D		$\frac{vf}{(mm/min)}$	560	955	1020	1100	1110	1080	1115	1030	1020

1. Pls pay attention to use machine and holder with high rigidity .
2. Please adjust the speed,feed and cutting depth according to actual cutting conditons.
3. The milling conditions are for an end mill where the tool overhang length is less than 4*D (mill dia).When the tool overhang length is longer, please adjust the speed,feed and cutting depth.

Recommended Cutting Data

US300-SS4、S4

Stainless Steels — Side Milling



Workpiece Material		Cutting Depth (mm)	Vc m/min	Tool Diameter (mm)	1	2	4	6	8	10	12
M	Stainless Steels	ap 1D	100 (80-120)	n (min-1)	20000	15900	7960	5300	3980	3180	2650
		ae 0.1D		vf (mm/min)	960	950	1110	950	950	890	850

US300-SS4、S4

Stainless Steels — Slotting



Workpiece Material		Cutting Depth (mm)	Vc m/min	Tool Diameter (mm)	1	2	4	6	8	10	12
M	Stainless Steels	ap 0.3D	45 (35-55)	n (min-1)	14300	7160	3580	2390	1790	1400	1200
		ae 1D		vf (mm/min)	340	250	215	300	300	300	300

1、Pls pay attention to use machine and holder with high rigidity .

2、Please adjust the speed,feed and cutting depth according to actual cutting conditons.

3、The milling conditions are for an end mill where the tool overhang length is less than 4*D (mill dia).When the tool overhang length is longer, please adjust the speed,feed and cutting depth.

Recommended Cutting Data

SS200-CS4、C4

For Stainless Steels — Side Milling



Workpiece Material		Cutting Depth (mm)	Vc m/min	Tool Diameter (mm)	2	4	6	8	10	12
M	Stainless Steels	ap 1D	80 (60-100)	n (min-1)	15900	7960	5300	3980	3180	2650
		ae 0.5D		vf (mm/min)	600	480	500	510	490	480

SS200-CS4、C4

For Stainless Steels — Slotting



Workpiece Material		Cutting Depth (mm)	Vc m/min	Tool Diameter (mm)	2	4	6	8	10	12
M	Stainless Steels	ap 1D	60 (50-70)	n (min-1)	9550	4780	3180	2390	1900	1590
		ae 1D		vf (mm/min)	500	350	350	380	350	350

1、Pls pay attention to use machine and holder with high rigidity .

2、Please adjust the speed,feed and cutting depth according to actual cutting conditons.

3、The milling conditions are for an end mill where the tool overhang length is less than 4*D (mill dia).When the tool overhang length is longer, please adjust the speed,feed and cutting depth.

Recommended Cutting Data

UA100-S2、SH2、R2、RH2
Aluminium Alloy —Side Milling



Workpiece Material		Cutting Depth (mm)	Vc m/min	Tool Diameter (mm)	1	2	4	6	8	10	12	16	20
N	Wrought Aluminum Alloys Cast Aluminum Alloys (Si≤12%)	ap 1.5D	150 (60-350)	n (min-1)	16000	12700	12000	10600	10000	9500	9280	7000	5600
		ae 0.2D		vf (mm/min)	580	710	1200	1280	1390	1720	2400	2500	2450
	Copper Alloys (<200HB)	ap 1.5D	150 (60-350)	n (min-1)	16000	12700	12000	10600	10000	9500	9280	7000	5600
		ae 0.2D		vf (mm/min)	520	650	1070	1150	1250	1550	2170	2250	2200

UA100-S2、SH2、R2、RH2
Aluminium Alloy —Slotting



Workpiece Material		Cutting Depth (mm)	Vc m/min	Tool Diameter (mm)	1	2	4	6	8	10	12	16	20
N	Wrought Aluminum Alloys Cast Aluminum Alloys (Si≤12%)	ap 0.5D	150 (60-350)	n (min-1)	16000	10000	9000	8000	7800	8000	6800	5000	4000
		ae=1D		vf (mm/min)	400	500	810	920	1100	1280	1300	1310	1200
	Copper Alloys (<200HB)	ap 0.5D	150 (60-350)	n (min-1)	16000	10000	9000	8000	7800	8000	6800	5000	4000
		ae=1D		vf (mm/min)	380	450	800	830	1000	1150	1130	1000	1080

UA100-SL2
Aluminium Alloy —Side Milling



Workpiece Material		Cutting Depth (mm)	Vc m/min	Tool Diameter (mm)	1	2	4	6	8	10	12	16	20
N	Wrought Aluminum Alloys Cast Aluminum Alloys (Si≤12%)	ap 2.5D	150 (60-350)	n (min-1)	16000	10000	9000	8000	7800	8000	6800	5000	4000
		ae 0.15D		vf (mm/min)	400	500	810	920	1100	1280	1300	1310	1200
	Copper Alloys (<200HB)	ap 2.5D	150 (60-350)	n (min-1)	16000	10000	9000	8000	7800	8000	6800	5000	4000
		ae 0.15D		vf (mm/min)	380	450	800	830	1000	1150	1130	1000	1080

1. Pls pay attention to use machine and holder with high rigidity .
2. Please adjust the speed,feed and cutting depth according to actual cutting conditons.
3. The milling conditions are for an end mill where the tool overhang length is less than 4*D (mill dia).When the tool overhang length is longer, please adjust the speed,feed and cutting depth.

Recommended Cutting Data

UA100-S3, SH3, R3, RH3

For Aluminium Alloy —Side Milling



Workpiece Material		Cutting Depth (mm)	Vc m/min	Tool Diameter (mm)	1	2	4	6	8	10	12	16	20
N	Wrought Aluminum Alloys Cast Aluminum Alloys (Si≤12%)	ap 1.5D	150 (60-350)	n (min-1)	16000	13000	12000	10600	10000	9500	9280	7000	5600
		ae 0.2D		vf (mm/min)	650	850	1430	1530	1670	2050	2800	3000	3150
	Copper Alloys (<200HB)	ap 1.5D	150 (60-350)	n (min-1)	16000	13000	12000	10600	10000	9500	9280	7000	5600
		ae 0.2D		vf (mm/min)	720	900	1200	1200	1500	1800	2225	2500	3000

UA100-S3, SH3, R3, RH3

For Aluminium Alloy —Slotting



Workpiece Material		Cutting Depth (mm)	Vc m/min	Tool Diameter (mm)	1	2	4	6	8	10	12	16	20
N	Wrought Aluminum Alloys Cast Aluminum Alloys (Si≤12%)	ap 0.5D	150 (60-350)	n (min-1)	16000	10000	9000	8000	7800	8000	6800	5000	4000
		ae=1D		vf (mm/min)	450	570	960	1050	1300	1500	1620	1680	1800
	Copper Alloys (<200HB)	ap 0.5D	150 (60-350)	n (min-1)	16000	10000	9000	8000	7800	8000	6800	5000	4000
		ae=1D		vf (mm/min)	450	520	860	830	960	1240	1500	1550	1510

UA100- SL3

For Aluminium Alloy —Side Milling



Workpiece Material		Cutting Depth (mm)	Vc m/min	Tool Diameter (mm)	1	2	4	6	8	10	12	16	20
N	Wrought Aluminum Alloys Cast Aluminum Alloys (Si≤12%)	ap 2.5D	150 (60-350)	n (min-1)	16000	10000	9000	8000	7800	8000	6800	5000	4000
		ae 0.15D		vf (mm/min)	450	570	960	1050	1300	1500	1620	1680	1800
	Copper Alloys (<200HB)	ap 2.5D	150 (60-350)	n (min-1)	16000	10000	9000	8000	7800	8000	6800	5000	4000
		ae 0.15D		vf (mm/min)	450	520	860	830	960	1240	1500	1550	1510

1. Pls pay attention to use machine and holder with high rigidity .
2. Please adjust the speed,feed and cutting depth according to actual cutting conditons.
3. The milling conditions are for an end mill where the tool overhang length is less than 4*D (mill dia).When the tool overhang length is longer, please adjust the speed,feed and cutting depth.

Recommended Cutting Data

UA100-B2

For Aluminium Alloy — Profiling



Workpiece Material		Cutting Depth (mm)	Vc m/min	Tool Diameter (mm)	1	2	4	6	8	10	12	16
N	Wrought Aluminum Alloys Cast Aluminum Alloys (Si≤12%)	ap 0.3D	150 (60-350)	n (min-1)	19000	15900	11900	10600	8000	7950	7950	7000
		ae 0.3D		vf (mm/min)	950	1600	1900	2500	2550	3200	3800	4450
	Copper Alloys (<200HB)	ap 0.3D	150 (60-350)	n (min-1)	19000	15900	11900	10600	8000	7950	7950	7000
		ae 0.3D		vf (mm/min)	860	1430	1720	2300	2300	2850	3450	4010

UA160-S2

For Aluminium Alloy — Side Milling



Workpiece Material		Cutting Depth (mm)	Vc m/min	Tool Diameter (mm)	1	2	4	6	8	10	12
N	Wrought Aluminum Alloys Cast Aluminum Alloys (Si≤12%)	ap 1.5D	150 (60-350)	n (min-1)	19000	16000	12000	10600	10000	9500	9300
		ae 0.2D		vf (mm/min)	760	950	1300	1380	1500	1900	2600
	Copper Alloys (<200HB)	ap 1.5D	150 (60-350)	n (min-1)	19000	16000	12000	10600	10000	9500	9300
		ae 0.2D		vf (mm/min)	690	860	1180	1240	1340	1720	2340

UA160-S2

For Aluminium Alloy — Slotting



Workpiece Material		Cutting Depth (mm)	Vc m/min	Tool Diameter (mm)	1	2	4	6	8	10	12
N	Wrought Aluminum Alloys Cast Aluminum Alloys (Si≤12%)	ap 0.5D	150 (60-350)	n (min-1)	16000	12800	10000	9300	8750	8000	7450
		ae=1D		vf (mm/min)	350	650	900	1100	1230	1280	1410
	Copper Alloys (<200HB)	ap 0.5D	150 (60-350)	n (min-1)	16000	12800	10000	9300	8750	8000	7450
		ae=1D		vf (mm/min)	300	570	800	970	1100	1150	1270

1. Pls pay attention to use machine and holder with high rigidity .
2. Please adjust the speed,feed and cutting depth according to actual cutting conditons.
3. The milling conditions are for an end mill where the tool overhang length is less than 4*D (mill dia).When the tool overhang length is longer, please adjust the speed,feed and cutting depth.

Recommended Cutting Data

UA160-S3

For Aluminium Alloy — Side Milling



Workpiece Material		Cutting Depth (mm)	Vc m/min	Tool Diameter (mm)	2	4	6	8	10	12
N	Wrought Aluminum Alloys Cast Aluminum Alloys (Si≤12%)	ap 1.5D	150 (60-350)	n (min-1)	16000	12000	10600	10000	9500	9300
		ae 0.2D		vf (mm/min)	1150	1570	1650	1800	2300	3100
	Copper Alloys (<200HB)	ap 1.5D	150 (60-350)	n (min-1)	16000	12000	10600	10000	9500	9300
		ae 0.2D		vf (mm/min)	1030	1420	1490	1610	2060	2800

UA160-S3

For Aluminium Alloy — Slotting



Workpiece Material		Cutting Depth (mm)	Vc m/min	Tool Diameter (mm)	2	4	6	8	10	12
N	Wrought Aluminum Alloys Cast Aluminum Alloys (Si≤12%)	ap 0.5D	150 (60-350)	n (min-1)	12800	10000	9300	8750	8000	7450
		ae=1D		vf (mm/min)	760	1080	1300	1470	1530	1700
	Copper Alloys (<200HB)	ap 0.5D	150 (60-350)	n (min-1)	12800	10000	9300	8750	8000	7450
		ae=1D		vf (mm/min)	690	970	1160	1320	1380	1530

UA160-S4

For Aluminium Alloy — Side Milling



Workpiece Material		Cutting Depth (mm)	Vc m/min	Tool Diameter (mm)	4	6	8	10	12
N	Wrought Aluminum Alloys Cast Aluminum Alloys (Si≤12%)	ap 1.5D	200 (120-350)	n (min-1)	16000	12000	10000	8000	6600
		ae 0.1D		vf (mm/min)	1500	1800	2000	2250	2500

1. Pls pay attention to use machine and holder with high rigidity .
2. Please adjust the speed,feed and cutting depth according to actual cutting conditons.
3. The milling conditions are for an end mill where the tool overhang length is less than 4*D (mill dia).When the tool overhang length is longer, please adjust the speed,feed and cutting depth.

Recommended Cutting Data

SA100-S3

For Aluminium Alloy—Side Milling



Workpiece Material		Cutting Depth (mm)	Vc m/min	Tool Diameter (mm)	2	4	6	8	10	12
N	Wrought Aluminum Alloys Cast Aluminum Alloys (Si≤12%)	ap 1.5D	150 (60-350)	n (min-1)	14000	12000	10000	9000	8500	8000
		ae 0.2D		vf (mm/min)	2000	3000	3500	4000	4500	5000
	Copper Alloys (<200HB)	ap 1.5D	150 (60-350)	n (min-1)	14000	12000	10000	9000	8500	8000
		ae 0.2D		vf (mm/min)	2000	3000	3500	4000	4500	5000

SA100-S3

For Aluminium Alloy—Slotting



Workpiece Material		Cutting Depth (mm)	Vc m/min	Tool Diameter (mm)	2	4	6	8	10	12
N	Wrought Aluminum Alloys Cast Aluminum Alloys (Si≤12%)	ap 1D	150 (60-350)	n (min-1)	11500	10000	9300	8750	8000	7450
		azte 1D		vf (mm/min)	1000	1500	2000	2500	3500	4000
	Copper Alloys (<200HB)	ap 1D	150 (60-350)	n (min-1)	11500	10000	9300	8750	8000	7450
		ae 1D		vf (mm/min)	1000	1500	2000	2500	3500	4000

- 1、Pls pay attention to use machine and holder with high rigidity .
- 2、Please adjust the speed,feed and cutting depth according to actual cutting conditons.
- 3、The milling conditions are for an end mill where the tool overhang length is less than 4*D (mill dia).When the tool overhang length is longer, please adjust the speed,feed and cutting depth.

Recommended Cutting Data

SA300-RN2

Aluminium Alloy — Side Milling



Workpiece Material		Cutting Depth (mm)	Vc m/min	Tool Diameter (mm)	10	12	16	20
N	Aluminum Alloy7075 , 7050 (Si < 6%)	ap 0.25D	400 (300-500)	n (min ⁻¹)	12000	10000	8000	7000
		ae 0.5D		vf (mm/min)	3600	3300	3200	3080

SA300-RN2

Aluminium Alloy — Slotting



Workpiece Material		Cutting Depth (mm)	Vc m/min	Tool Diameter (mm)	10	12	16	20
N	Aluminum Alloy7075 , 7050 (Si < 6%)	ap 0.2D	400 (300-500)	n (min ⁻¹)	12000	10000	8000	7000
		ae 1D		vf (mm/min)	3360	3200	3040	2940

- 1、 Pls pay attention to use machine and holder with high rigidity .
- 2、 Please adjust the speed,feed and cutting depth according to actual cutting conditons.
- 3、 The milling conditions are for an end mill where the tool overhang length is less than 4*D (mill dia).When the tool overhang length is longer, please adjust the speed,feed and cutting depth.

Recommended Cutting Data

SA300-RN3

Aluminium Alloy — Side Milling



Workpiece Material	Cutting Depth (mm)	Vc m/min	Tool Diameter (mm)	12	16	20
 Aluminum Alloy7075 , 7050 (Si < 6%)	ap 0.25D	400 (300-500)	n (min-1)	10000	8000	7000
	ae 0.5D		vf (mm/min)	4500	4250	4100

SA300-RN3

Aluminium Alloy — Slotting



Workpiece Material	Cutting Depth (mm)	Vc m/min	Tool Diameter (mm)	12	16	20
 Aluminum Alloy7075 , 7050 (Si < 6%)	ap 0.2D	400 (300-500)	n (min-1)	10000	8000	7000
	ae 1D		vf (mm/min)	4200	3960	3880

SA300-BN2

Aluminium Alloy — Profiling



Workpiece Material	Cutting Depth (mm)	Vc m/min	Tool Diameter (mm)	10	12	16	20
 Aluminum Alloy7075 , 7050 (Si < 6%)	ap 0.1D	400 (300-500)	n (min-1)	12000	12000	8000	8000
	ae 0.2D		vf (mm/min)	3840	4320	3520	4000

- 1、 Pls pay attention to use machine and holder with high rigidity .
- 2、 Please adjust the speed,feed and cutting depth according to actual cutting conditons.
- 3、 The milling conditions are for an end mill where the tool overhang length is less than 4*D (mill dia).When the tool overhang length is longer, please adjust the speed,feed and cutting depth.

Recommended Cutting Data

SA310-RN2

Aluminium Alloy — Side Milling



Workpiece Material		Cutting Depth (mm)	Vc m/min	Tool Diameter (mm)	10	12	16	20	25	32
N	Aluminum Alloy7075 , 7050 (Si < 6%)	ap 0.25D	900 (700-1100)	n (min-1)	20000	20000	20000	20000	18000	18000
		ae 0.5D		vf (mm/min)	5200	6000	6600	6800	7560	7920

SA310-RN3

Aluminium Alloy — Side Milling



Workpiece Material		Cutting Depth (mm)	Vc m/min	Tool Diameter (mm)	12	16	20	25	32
N	Aluminum Alloy7075 , 7050 (Si < 6%)	ap 0.25D	900 (700-1100)	n (min-1)	20000	20000	20000	18000	18000
		ae 0.5D		vf (mm/min)	8400	9000	9000	10000	10800

SA360-RN2

Aluminium Alloy — Side Milling



Workpiece Material		Cutting Depth (mm)	Vc m/min	Tool Diameter (mm)	12	16	20	25
N	Aluminum Alloy7075 , 7050 (Si < 6%)	ap 0.25D	1300 (1100-1500)	n (min-1)	22000	20000	20000	18000
		ae 0.5D		vf (mm/min)	6160	6400	7800	8000

1. Pls pay attention to use machine and holder with high rigidity .
2. Please adjust the speed,feed and cutting depth according to actual cutting conditons.
3. The milling conditions are for an end mill where the tool overhang length is less than 4*D (mill dia).When the tool overhang length is longer, please adjust the speed,feed and cutting depth.

Recommended Cutting Data

SG200- S2、SN2、R2、RN2

For Graphite—Side Milling



Workpiece Material		Cutting Depth (mm)	Vc m/min	Tool Diameter (mm)	2	4	6	8	10	12
N	For High silicon aluminum (Si > 12%)	ap 1D	200	n (min-1)	31850	15920	10620	7960	6370	5310
		ae 0.15D		vf (mm/min)	1910	1590	1270	1120	1080	1380
	For Graphite	ap 1.5D	250	n (min-1)	39810	19900	13270	9950	7960	6640
		ae 0.5D		vf (mm/min)	3980	2790	2390	2190	2390	2390

SG200-S3

For Graphite —Side Milling



Workpiece Material		Cutting Depth (mm)	Vc m/min	Tool Diameter (mm)	2	4	6	8	10	12
N	For High silicon aluminum (Si > 12%)	ap 1D	200	n (min-1)	31850	15920	10620	7960	6370	5310
		ae 0.15D		vf (mm/min)	2870	2390	1910	1670	1620	2070
	For Graphite	ap 1.5D	250	n (min-1)	39810	19900	13270	9950	7960	6640
		ae 0.5D		vf (mm/min)	5970	4180	3580	3280	3580	3580

SG200- S4、R4、RN4

For Graphite—Side Milling



Workpiece Material		Cutting Depth (mm)	Vc m/min	Tool Diameter (mm)	2	4	6	8	10	12
N	For High silicon aluminum (Si > 12%)	ap 1D	200	n (min-1)	31850	15920	10620	7960	6370	5310
		ae 0.15D		vf (mm/min)	3820	3190	2550	2230	2170	2760
	For Graphite	ap 1.5D	250	n (min-1)	39810	19900	13270	9950	7960	6640
		ae 0.5D		vf (mm/min)	7960	5570	4780	4380	4780	4780

1、Pls pay attention to use machine and holder with high rigidity .

2、Please adjust the speed,feed and cutting depth according to actual cutting conditons.

3、The milling conditions are for an end mill where the tool overhang length is less than 4*D (mill dia).When the tool overhang length is longer, please adjust the speed,feed and cutting depth.

Recommended Cutting Data

SG200- S2、SN2、 R2、 RN2 For High silicon aluminum
For Graphite ——Slotting



Workpiece Material		Cutting Depth (mm)	Vc m/min	Tool Diameter (mm)	2	4	6	8	10	12
N	For High silicon aluminum (Si > 12%)	ap 0.5D	180	n (min-1)	28660	14330	9550	7170	5730	4780
				vf (mm/min)	1150	1150	960	860	800	860
	For Graphite	ap 0.5D	200	n (min-1)	31850	15920	10620	7960	6370	5310
				vf (mm/min)	1910	1430	1380	1350	1400	1590

SG200-S3 For High silicon aluminum
For Graphite ——Slotting



Workpiece Material		Cutting Depth (mm)	Vc m/min	Tool Diameter (mm)	2	4	6	8	10	12
N	For High silicon aluminum (Si > 12%)	ap 0.5D	180	n (min-1)	28660	14330	9550	7170	5730	4780
				vf (mm/min)	1720	1720	1430	1290	1200	1290
	For Graphite	ap 0.5D	200	n (min-1)	31850	15920	10620	7960	6370	5310
				vf (mm/min)	2870	2150	2070	2030	2100	2390

SG200-B2、BN2 For High silicon aluminum
For Graphite——Profiling



Workpiece Material		Cutting Depth (mm)	Vc m/min	Tool Diameter (mm)	2	4	6	8	10	12
N	For High silicon aluminum (Si > 12%)	ap 0.3D	200	n (min-1)	31850	15920	10620	7960	6370	5310
		ae 0.3D		vf (mm/min)	2040	1430	1270	1270	1400	1380
	For Graphite	ap 0.5D	250	n (min-1)	39810	19900	13270	9950	7960	6640
		ae 0.4D		vf (mm/min)	2790	1990	1860	1790	1910	1990

- 1、Pls pay attention to use machine and holder with high rigidity .
- 2、Please adjust the speed,feed and cutting depth according to actual cutting conditons.
- 3、The milling conditions are for an end mill where the tool overhang length is less than 4*D (mill dia).When the tool overhang length is longer, please adjust the speed,feed and cutting depth.

Recommended Cutting Data

SD200-KDA

For Composite material—Side Milling



Workpiece Material		Cutting Depth (mm)	Vc m/min	Tool Diameter (mm)	6	8	10	12
N	Carbon Fiber CFRP	ap 2D	140 (80-200)	n (min-1)	7430	5570	4460	3715
		ae 0.2D		vf (mm/min)	445	445	445	370
	Glass Fiber GFRP	ap 2D	150 (100-200)	n (min-1)	7960	5970	4775	3980
		ae 0.2D		vf (mm/min)	475	475	475	400

SD200-KDA

For Composite material—Slotting



Workpiece Material		Cutting Depth (mm)	Vc m/min	Tool Diameter (mm)	6	8	10	12
N	Carbon Fiber CFRP	ap 1D	120 (80-160)	n (min-1)	6370	4775	3820	3185
		ae 1D		vf (mm/min)	255	285	305	320
	Glass Fiber GFRP	ap 1D	150 (100-200)	n (min-1)	7960	5970	4775	3980
		ae 1D		vf (mm/min)	320	360	380	400

SD200-J2

For Composite material—Side Milling



Workpiece Material		Cutting Depth (mm)	Vc m/min	Tool Diameter (mm)	4	6	8	10	12
N	Carbon Fiber CFRP	ap 2D	140 (80-200)	n (min-1)	10350	6900	5175	4140	3450
		ae 0.2D		vf (mm/min)	621	483	414	414	345
	Glass Fiber GFRP	ap 2D	150 (100-200)	n (min-1)	9554	6369	4777	3822	3185
		ae 0.2D		vf (mm/min)	573	445	382	382	318

1. Pls pay attention to use machine and holder with high rigidity .
2. Please adjust the speed,feed and cutting depth according to actual cutting conditons.
3. The milling conditions are for an end mill where the tool overhang length is less than 4*D (mill dia).When the tool overhang length is longer, please adjust the speed,feed and cutting depth.

Recommended Cutting Data

SN200-R4
For HRSA — Side Milling



Workpiece Material		Cutting Depth (mm)	Vc m/min	Tool Diameter (mm)	6	8	10	12	16	20
S	TA Titanium Alloys	ap 1D	25 (15-35)	n (min-1)	1325	995	795	660	495	400
		ae 0.1D		vf (mm/min)	160	160	190	185	160	160
	TC Titanium Alloys	ap 1D	20 (15-30)	n (min-1)	1060	795	635	530	400	320
		ae 0.1D		vf (mm/min)	125	125	150	145	125	125
	TB Titanium Alloys	ap 1D	25 (15-30)	n (min-1)	1325	995	795	660	495	400
		ae 0.1D		vf (mm/min)	160	160	190	185	160	160

SN200-R4
For HRSA — Slotting



Workpiece Material		Cutting Depth (mm)	Vc m/min	Tool Diameter (mm)	6	8	10	12	16	20
S	TA Titanium Alloys	ap 0.5D	20 (10-30)	n (min-1)	1060	795	635	530	400	320
		ae 1D		vf (mm/min)	105	95	90	95	80	70
	TC Titanium Alloys	ap 0.5D	15 (10-25)	n (min-1)	795	600	475	400	300	240
		ae 1D		vf (mm/min)	65	60	60	60	60	50
	TB Titanium Alloys	ap 0.5D	20 (10-30)	n (min-1)	1060	795	635	530	400	320
		ae 1D		vf (mm/min)	105	95	90	95	80	70

1. Maximum T.I.R. in when tool is chucked is 0.01mm(0.01mm maximum recommended).
2. Pls pay attention to use machine and holder with high rigidity .
3. Please adjust the speed,feed and cutting depth according to actual cutting conditons.
4. The milling conditions are for an end mill where the tool overhang length is less than 4*D (mill dia).When the tool overhang length is longer, please adjust the speed,feed and cutting depth.

Recommended Cutting Data

SN200-B4

For HRSA—Profiling



Workpiece Material		Cutting Depth (mm)	Vc m/min	Tool Diameter (mm)	6	8	10	12	16	20
S	TA Titanium Alloys	ap 0.04D	40 (30-50)	n (min-1)	2120	1590	1270	1060	795	635
		ae 0.04D		vf (mm/min)	255	285	305	340	320	305
	TC Titanium Alloys	ap 0.04D	35 (25-45)	n (min-1)	1855	1390	1115	930	695	555
		ae 0.04D		vf (mm/min)	220	220	265	260	280	265
	TB Titanium Alloys	ap 0.03D	40 (30-50)	n (min-1)	2120	1590	1270	1060	795	635
		ae 0.03D		vf (mm/min)	255	285	305	320	320	305

- 1、Maximum T.I.R. in when tool is chucked is 0.01mm(0.01mm maximum recommended).
- 2、Pls pay attention to use machine and holder with high rigidity .
- 3、Please adjust the speed,feed and cutting depth according to actual cutting conditons.
- 4、The milling conditions are for an end mill where the tool overhang length is less than 4*D (mill dia).When the tool overhang length is longer, please adjust the speed,feed and cutting depth.

Recommended Cutting Data

ST200—S4, R4, RN4

Titanium Alloys—Side Milling



Workpiece Material		Cutting Depth (mm)	Vc m/min	Tool Diameter (mm)	6	8	10	12	16	20	25
S	TA Titanium Alloys	ap 1.5D	75 (60-90)	n (min-1)	3980	2985	2390	1990	1490	1195	955
		ae 0.1D		vf (mm/min)	715	655	575	555	480	450	360
	TC Titanium Alloys	ap 1.5D	70 (60-80)	n (min-1)	3715	2785	2230	1855	1390	1115	890
		ae 0.1D		vf (mm/min)	670	610	535	480	445	420	340
	TB Titanium Alloys	ap 1.5D	45 (40-60)	n (min-1)	2390	1790	1430	1195	895	715	570
		ae 0.1D		vf (mm/min)	430	395	340	310	285	270	215

ST200-S4, R4, RN4

Titanium Alloys—Slotting



Workpiece Material		Cutting Depth (mm)	Vc m/min	Tool Diameter (mm)	6	8	10	12	16	20	25
S	TA Titanium Alloys	ap 0.3D	65 (50-80)	n (min-1)	3450	2585	2070	1725	1290	1035	830
		ae 1D		vf (mm/min)	620	570	495	480	415	370	300
	TC Titanium Alloys	ap 0.3D	60 (50-70)	n (min-1)	3185	2390	1910	1590	1195	955	765
		ae 1D		vf (mm/min)	570	525	460	415	380	340	275
	TB Titanium Alloys	ap 0.25D	40 (30-50)	n (min-1)	2120	1590	1270	1060	795	635	510
		ae 1D		vf (mm/min)	380	350	305	275	255	230	180

1. Make sure workpiece and machine are suitable, use high quality collect chucks.
2. Please adjust the speed feed and cutting depth according to actual cutting conditions.
3. The milling condition are for an endmill where the tool overhang length is less than 4D. When the tool overhang length is longer, please adjust the speed, feed and cutting depth.
4. If corner radius is > 15% of D then ap=-30% , fz=-20%.

Recommended Cutting Data

ST200—RN5、RL5

Titanium Alloys —Side Milling



Workpiece Material		Cutting Depth (mm)	Vc m/min	Tool Diameter (mm)	16	20	25
S	TA Titanium Alloys	ap 0.7*Lc	75 (60-90)	n (min-1)	1490	1195	955
		ae 0.1D		vf (mm/min)	600	565	450
	TC Titanium Alloys	ap 0.7*Lc	70 (60-80)	n (min-1)	1390	1115	890
		ae 0.1D		vf (mm/min)	560	530	420
	TB Titanium Alloys	ap 0.7*Lc	45 (40-60)	n (min-1)	895	715	570
		ae 0.1D		vf (mm/min)	360	340	270

If applying ST200-RL5 to the shoulder milling of titanium alloys, The cutting parameter should be decrease to 30%, Lc is tool length.

ST200-RN5

Titanium Alloys —Slotting



Workpiece Material		Cutting Depth (mm)	Vc m/min	Tool Diameter (mm)	16	20	25
S	TA Titanium Alloys	ap 0.3D	65 (50-80)	n (min-1)	1290	1035	830
		ae 1D		vf (mm/min)	515	465	370
	TC Titanium Alloys	ap 0.3D	60 (50-70)	n (min-1)	1195	955	765
		ae 1D		vf (mm/min)	475	430	340
	TB Titanium Alloys	ap 0.25D	40 (30-50)	n (min-1)	795	635	510
		ae 1D		vf (mm/min)	320	285	230

2. Please adjust the speed feed and cutting depth according to actual cutting conditions.

3. The milling condition are for an endmill where the tool overhang length is less than 4D. When the tool overhang length is longer, please adjust the speed, feed and cutting depth.

4. If corner radius is > 15% of D then ap=-30% , fz=-20%.

Recommended Cutting Data

ST200-B4

Titanium Alloys—Profiling



Workpiece Material		Cutting Depth (mm)	Vc m/min	Tool Diameter (mm)	6	8	10	12	16
S	TA Titanium Alloys	ap 0.2D	75 (60-90)	n (min ⁻¹)	3980	2985	2390	1990	1490
		ae 0.3D		vf (mm/min)	795	715	670	600	480
	TC Titanium Alloys	ap 0.2D	70 (60-80)	n (min ⁻¹)	3715	2785	2230	1860	1390
		ae 0.3D		vf (mm/min)	670	610	535	480	445
	TB Titanium Alloys	ap 0.2D	45 (40-60)	n (min ⁻¹)	2390	1790	1430	1195	895
		ae 0.3D		vf (mm/min)	430	395	345	310	285

2. Please adjust the speed feed and cutting depth according to actual cutting conditions.

3. The milling condition are for an endmill where the tool overhang length is less than 4D. When the tool overhang length is longer, please adjust the speed, feed and cutting depth.

4. If corner radius is > 15% of D then ap=-30% , fz=-20%.

Recommended Cutting Data

ST260-RN4

Titanium Alloys — Side Milling



Workpiece Material		Cutting Depth (mm)	Vc m/min	Tool Diameter (mm)	10	12	16	20	25
S	TA Titanium Alloys	ap 1.5D	85 (60-110)	n (min-1)	2705	2255	1690	1350	1080
		ae 0.2D		vf (mm/min)	650	630	540	515	410
	TC Titanium Alloys	ap 1.5D	80 (60-100)	n (min-1)	2550	2120	1590	1275	1020
		ae 0.2D		vf (mm/min)	610	550	510	485	385
	TB Titanium Alloys	ap 1.5D	50 (40-60)	n (min-1)	1590	1325	995	795	635
		ae 0.2D		vf (mm/min)	380	345	320	300	240

ST260-RN4

Titanium Alloys — Slotting



Workpiece Material		Cutting Depth (mm)	Vc m/min	Tool Diameter (mm)	10	12	16	20	25
S	TA Titanium Alloys	ap 0.3D	75 (50-90)	n (min-1)	2390	1990	1490	1195	955
		ae 1D		vf (mm/min)	570	560	475	430	345
	TC Titanium Alloys	ap 0.3D	70 (50-80)	n (min-1)	2230	1860	1390	1115	890
		ae 1D		vf (mm/min)	535	480	445	400	320
	TB Titanium Alloys	ap 0.25D	50 (40-60)	n (min-1)	1590	1325	995	795	635
		ae 1D		vf (mm/min)	380	345	320	285	230

2. Please adjust the speed feed and cutting depth according to actual cutting conditions.

3. The milling condition are for an endmill where the tool overhang length is less than 4D. When the tool overhang length is longer, please adjust the speed, feed and cutting depth.

4. If corner radius is > 15% of D then ap=-30% , fz=-20%.

Recommended Cutting Data

ST300-RN4

Titanium Alloys—Side Milling



Workpiece Material		Cutting Depth (mm)	Vc m/min	Tool Diameter (mm)	12	16	20
S	TA Titanium Alloys	ap 1.5D	100 (80-120)	n (min-1)	2650	1990	1590
		ae 0.2D		vf (mm/min)	740	635	605
	TC Titanium Alloys	ap 1.5D	100 (80-120)	n (min-1)	2650	1990	1590
		ae 0.2D		vf (mm/min)	690	635	570
	TB Titanium Alloys	ap 1.5D	80 (60-100)	n (min-1)	2120	1590	1270
		ae 0.2D		vf (mm/min)	550	510	460

ST300-RN4

Titanium Alloys—Slotting



Workpiece Material		Cutting Depth (mm)	Vc m/min	Tool Diameter (mm)	12	16	20
S	TA Titanium Alloys	ap 1D	80 (60-100)	n (min-1)	2120	1590	1275
		ae 1D		vf (mm/min)	595	510	485
	TC Titanium Alloys	ap 1D	80 (60-100)	n (min-1)	2120	1590	1275
		ae 1D		vf (mm/min)	550	510	460
	TB Titanium Alloys	ap 1D	50 (40-60)	n (min-1)	1460	1095	875
		ae 1D		vf (mm/min)	380	350	315

2. Please adjust the speed feed and cutting depth according to actual cutting conditions.

3. The milling condition are for an endmill where the tool overhang length is less than 4D. When the tool overhang length is longer, please adjust the speed, feed and cutting depth.

4. If corner radius is > 15% of D then ap=-30% , fz=-20%.

Recommended Cutting Data

ST300-RN5

Titanium Alloys — Side Milling



Workpiece Material		Cutting Depth (mm)	Vc m/min	Tool Diameter (mm)	16	20	25
S	TA Titanium Alloys	ap 1.5D	100 (80-120)	n (min ⁻¹)	1990	1590	1270
		ae 0.2D		vf (mm/min)	795	755	605
	TC Titanium Alloys	ap 1.5D	100 (80-120)	n (min ⁻¹)	1990	1590	1270
		ae 0.2D		vf (mm/min)	795	715	570
	TB Titanium Alloys	ap 1.5D	80 (60-100)	n (min ⁻¹)	1590	1270	1020
		ae 0.2D		vf (mm/min)	635	570	460

ST300-RN5

Titanium Alloys — Slotting



Workpiece Material		Cutting Depth (mm)	Vc m/min	Tool Diameter (mm)	16	20	25
S	TA Titanium Alloys	ap 1D	80 (60-100)	n (min ⁻¹)	1590	1275	1020
		ae 1D		vf (mm/min)	635	605	485
	TC Titanium Alloys	ap 1D	80 (60-100)	n (min ⁻¹)	1590	1275	1020
		ae 1D		vf (mm/min)	635	570	460
	TB Titanium Alloys	ap 1D	50 (40-60)	n (min ⁻¹)	1095	875	700
		ae 1D		vf (mm/min)	435	395	315

2. Please adjust the speed feed and cutting depth according to actual cutting conditions.

3. The milling condition are for an endmill where the tool overhang length is less than 4D. When the tool overhang length is longer, please adjust the speed, feed and cutting depth.

4. If corner radius is > 15% of D then ap=-30% , fz=-20%.

Recommended Cutting Data

SH160-S2、R2

For Alloy Steels, Hardened Steel—Side Milling



Workpiece Material		Cutting Depth (mm)	Vc m/min	Tool Diameter (mm)	2	4	6	8	10	12	16	20
H	Alloy Steel Hardened Steel (< 55HRC)	ap 1D	120	n (min-1)	19110	9550	6370	4780	3820	3190	2390	1910
		ae 0.05D		vf (mm/min)	380	380	380	380	370	360	310	290
	Alloy Steel Hardened Steel (55-60HRC)	ap 0.7D	90	n (min-1)	15920	11940	7960	5970	4780	3980	2990	2390
		ae 0.03D		vf (mm/min)	260	360	370	360	360	330	320	290

SH160-S4、SH4、S6、R4、RH4

For Alloy Steels, Hardened Steel—Side Milling



Workpiece Material		Cutting Depth (mm)	Vc m/min	Tool Diameter (mm)	2	4	6	8	10	12	16	20
H	Alloy Steel Hardened Steel (< 55HRC)	ap 1D	120	n (min-1)	19110	9550	6370	4780	3820	3190	2390	1910
		ae 0.05D		vf (mm/min)	760	760	760	760	730	710	620	570
	Alloy Steel Hardened Steel (55-60HRC)	ap 0.7D	90	n (min-1)	15920	11940	7960	5970	4780	3980	2990	2390
		ae 0.03D		vf (mm/min)	510	720	730	720	730	670	630	570

1、 Please attention to use machine and holder with high rigidity .

2、 Please adjust the speed,feed and cutting depth according to actual cutting conditons.

3、 The milling conditions are for an end mill where the tool overhang length is less than 4*D (mill dia).When the tool overhang length is longer, please adjust the speed,feed and cutting depth.

Recommended Cutting Data

SH160-B2、BH2

For Alloy Steels, Hardened Steel——Profiling



Workpiece Material		Cutting Depth (mm)	Vc m/min	Tool Diameter (mm)	2	4	6	8	10	12	14	16
H	Alloy Steel Hardened Steel (< 55HRC)	ap 0.03D	200	n (min-1)	31850	15920	10620	7960	6370	5310	4550	3980
		ae 0.03D		vf (mm/min)	510	570	590	610	570	570	530	490
	Alloy Steel Hardened Steel (55-60HRC)	ap 0.02D	150	n (min-1)	23890	11940	7960	5970	4780	3980	3410	2990
		ae 0.03D		vf (mm/min)	330	310	320	330	330	320	310	300

SH160-B4

For Alloy Steels, Hardened Steel——Profiling



Workpiece Material		Cutting Depth (mm)	Vc m/min	Tool Diameter (mm)	2	4	6	8	10	12	14	16
H	Alloy Steel Hardened Steel (< 55HRC)	ap 0.03D	200	n (min-1)	31850	15920	10620	7960	6370	5310	4550	3980
		ae 0.03D		vf (mm/min)	1020	1150	1190	1210	1150	1150	1060	990
	Alloy Steel Hardened Steel (55-60HRC)	ap 0.02D	150	n (min-1)	23890	11940	7960	5970	4780	3980	3410	2990
		ae 0.03D		vf (mm/min)	670	620	640	670	670	640	610	600

- 1、Please attention to use machine and holder with high rigidity .
- 2、Please adjust the speed,feed and cutting depth according to actual cutting conditons.
- 3、The milling conditions are for an end mill where the tool overhang length is less than 4*D (mill dia).When the tool overhang length is longer, please adjust the speed,feed and cutting depth.

Recommended Cutting Data

SH200-S4, SH4, SL4, SN4, R4, RH4, RN4-H
For Alloy Steels, Hardened Steel—Side Milling



Workpiece Material		Condition Range	Cutting Depth (mm)	Vc (m/min)	Tool Diameter (mm)	2	4	6	8	10	12
H	Alloy Steel Hardened Steel (< 55HRC)	High Speed	ap 0.5D	220	n (min-1)	35000	17500	11600	8700	7000	5800
			ae 0.02D		vf (mm/min)	1400	1400	1400	1400	1300	1300
	Alloy Steel Hardened Steel (55-60HRC)	General	ap 1D	100	n (min-1)	15900	7900	5300	3900	3100	2600
			ae 0.05D		vf (mm/min)	630	630	630	600	590	580
	Alloy Steel Hardened Steel (< 55HRC)	High Speed	ap 0.3D	140	n (min-1)	22000	11000	7400	5500	4400	3700
			ae 0.01D		vf (mm/min)	700	660	680	660	670	620
	Alloy Steel Hardened Steel (55-60HRC)	General	ap 0.7D	80	n (min-1)	12700	6400	4200	3200	2500	2100
			ae 0.03D		vf (mm/min)	400	380	390	380	380	350

SH200-B2, BH2, BN2-H
For Alloy Steels, Hardened Steel—Profiling



Workpiece Material		Condition Range	Cutting Depth (mm)	Vc (m/min)	Tool Diameter (mm)	2	4	6	8	10	12
H	Alloy Steel Hardened Steel (< 55HRC)	High Speed	ap 0.03D	220	n (min-1)	35000	17500	11600	8700	7000	5800
			ae 0.03D		vf (mm/min)	1400	1400	1400	1400	1300	1300
		General	ap 0.08D	150	n (min-1)	24000	12000	7900	5900	4800	4000
			ae 0.03D		vf (mm/min)	960	960	950	950	890	900

1. Please attention to use machine and holder with high rigidity .
2. Please adjust the speed,feed and cutting depth according to actual cutting conditons.
3. The milling conditions are for an end mill where the tool overhang length is less than 4*D (mill dia).When the tool overhang length is longer, please adjust the speed,feed and cutting depth.

Recommended Cutting Data

SH300-S2, SN2, R2, RN2-H

For Alloy Steels, Hardened Steel—Side Milling



Workpiece Material		Cutting Depth (mm)	Vc m/min	Tool Diameter (mm)	1	2	4	6	8	10	12
H	Alloy Steel Hardened Steel (< 55HRC)	ap 1D	100	n (min-1)	25400	15900	7960	5300	3980	3180	2650
		ae 0.02D		vf (mm/min)	500	570	560	530	480	480	430
	Alloy Steel Hardened Steel (55-60HRC)	ap 1D	80	n (min-1)	19100	12700	6370	4250	3180	2550	2120
		ae 0.015D		vf (mm/min)	280	300	320	290	280	260	260
	Alloy Steel Hardened Steel (> 60HRC)	ap 1D	60	n (min-1)	16000	9550	4780	3180	2390	1910	1590
		ae 0.01D		vf (mm/min)	160	190	200	200	180	160	160

SH300-SS4, S4, SH4, SL4, SN4, R4, RH4, RN4-H
For Alloy Steels, Hardened Steel—Side Milling



Workpiece Material		Cutting Depth (mm)	Vc m/min	Tool Diameter (mm)	1	2	4	6	8	10	12	14	16	20
H	Alloy Steel Hardened Steel (< 55HRC)	ap≤1D	150	n (min-1)	40000	24000	12000	8000	6000	4800	4000	3400	3000	2400
		ae≤0.02D		vf (mm/min)	1350	1440	2400	1760	1440	1248	1200	1088	1080	960
	Alloy Steel Hardened Steel (55-60HRC)	ap≤1D	120	n (min-1)	30000	18000	10350	6900	5175	4140	3450	3000	2500	2000
		ae≤0.015D		vf (mm/min)	1000	1080	2070	1518	1242	1076.4	1035	960	900	800
	Alloy Steel Hardened Steel (> 60HRC)	ap≤1D	100	n (min-1)	20000	14000	7960	5300	4000	3280	2600	2300	2000	1600
		ae≤0.01D		vf (mm/min)	800	840	1592	1166	960	852.8	780	736	720	640

- 1、 Please attention to use machine and holder with high rigidity .
- 2、 Please adjust the speed,feed and cutting depth according to actual cutting conditons.
- 3、 The milling conditions are for an end mill where the tool overhang length is less than 4*D (mill dia).When the tool overhang length is longer, please adjust the speed,feed and cutting depth.

Recommended Cutting Data

SH300-S6, SH6, SL6, R6, RH6, RL6-H

For Alloy Steels, Hardened Steel—Side Milling



Workpiece Material		Cutting Depth (mm)	Vc (m/min)	Tool Diameter (mm)	6	8	10	12	14	16	20
H	Alloy Steel Hardened Steel (< 55HRC)	ap 1.5D	120	n (min-1)	6200	4800	4000	3200	2800	2400	1600
		ae 0.03D		vf (mm/min)	1674	1584	1560	1440	1344	1296	960
	Alloy Steel Hardened Steel (55-60HRC)	ap 1.5D	100	n (min-1)	4500	3600	3000	2400	2100	1800	1200
		ae 0.025D		vf (mm/min)	1215	1188	1170	1080	1020	972	720
	Alloy Steel Hardened Steel (> 60HRC)	ap 1.5D	70	n (min-1)	3100	2400	2000	1600	1400	1200	800
		ae 0.02D		vf (mm/min)	744	720	720	627	600	576	432

SH300-B2, BH2, BN2-H

For Alloy Steels, Hardened Steel—Profiling



Workpiece Material		Cutting Depth (mm)	Vc (m/min)	Tool Diameter (mm)	0.6	1	2	4	6	8	10	12
H	Alloy Steel Hardened Steel (< 55HRC)	ap 0.01D	150	n (min-1)	44000	23000	16000	10000	7400	5700	4500	3800
		ae 0.02D		vf (mm/min)	1100	1200	1770	1680	1500	1300	1100	1000
	Alloy Steel Hardened Steel (55-60HRC)	ap 0.015D	120	n (min-1)	41000	21000	14000	9500	5100	4100	3500	2600
		ae 0.015D		vf (mm/min)	1000	1200	1480	1390	1300	1170	1000	800
	Alloy Steel Hardened Steel (> 60HRC)	ap 0.01D	90	n (min-1)	40000	20000	13000	7000	5100	3900	3100	2600
		ae 0.01D		vf (mm/min)	700	800	1300	1100	960	800	700	600

1. Please attention to use machine and holder with high rigidity .
2. Please adjust the speed,feed and cutting depth according to actual cutting conditons.
3. The milling conditions are for an end mill where the tool overhang length is less than 4*D (mill dia).When the tool overhang length is longer, please adjust the speed,feed and cutting depth.

Recommended Cutting Data

SH300-B4, BH4, BN4-H

For Alloy Steels, Hardened Steel—Profiling Roughing



Workpiece Material		Cutting Depth (mm)	Vc (m/min)	Tool Diameter (mm)	2	4	6	8	10	12
H	Alloy Steel Hardened Steel (< 55HRC)	ap 0.08D	130	n (min-1)	21000	10350	6900	5175	4140	3450
		ae 0.18D		vf (mm/min)	2520	2484	2484	2270	2150	2070
	Alloy Steel Hardened Steel (55-60HRC)	ap 0.06D	100	n (min-1)	15120	7560	5040	3780	3020	2520
		ae 0.13D		vf (mm/min)	1210	1210	1310	1280	1200	1210
	Alloy Steel Hardened Steel (> 60HRC)	ap 0.04D	80	n (min-1)	12740	6370	4250	3180	2550	2120
		ae 0.08D		vf (mm/min)	920	1020	980	890	920	850

SH300-B4, BH4, BN4-H

For Alloy Steels, Hardened Steel—Profiling Finishing



Workpiece Material		Cutting Depth (mm)	Vc (m/min)	Tool Diameter (mm)	2	4	6	8	10	12
H	Alloy Steel Hardened Steel (< 55HRC)	ap 0.03D	180	n (min-1)	29460	14700	9800	7360	5890	4900
		ae 0.02D		vf (mm/min)	2360	2640	2660	2650	2590	2700
	Alloy Steel Hardened Steel (55-60HRC)	ap 0.02D	150	n (min-1)	23880	11940	7960	5970	4780	3980
		ae 0.02D		vf (mm/min)	1720	1760	1850	1860	1870	1910
	Alloy Steel Hardened Steel (> 60HRC)	ap 0.01D	130	n (min-1)	20700	10350	6900	5180	4140	3450
		ae 0.01D		vf (mm/min)	1160	1240	1240	1300	1320	1240

1. Please attention to use machine and holder with high rigidity .
2. Please adjust the speed,feed and cutting depth according to actual cutting conditons.
3. The milling conditions are for an end mill where the tool overhang length is less than 4*D (mill dia).When the tool overhang length is longer, please adjust the speed,feed and cutting depth.

Recommended Cutting Data

FH200-R4、RN4-H

For Alloy Steels, Hardened Steel—Face Milling



Workpiece Material		Cutting Depth (mm)	Vc (m/min)	Tool Diameter (mm)	1	2	4	6	8	10	12
P	Alloy Steel (< 48HRC)	ap 0.03D	150	n (min ⁻¹)	40000	24000	12000	8000	6500	5000	4500
		ae 0.5D		vf (mm/min)	2640	3120	3840	5760	5760	5800	5200
H	Hardened Steel (45-55HRC)	ap 0.025D	125	n (min ⁻¹)	33000	20000	10000	7000	5500	4000	3500
		ae 0.5D		vf (mm/min)	2200	2600	3200	4800	4800	4400	3800
	Hardened Steel (55-65HRC)	ap 0.02D	90	n (min ⁻¹)	23000	14000	7200	5000	3600	3000	2500
		ae 0.5D		vf (mm/min)	2000	2500	2800	3500	3300	3000	2600

Remarks :

- Turning red is a normal phenomenon in the process of processing. As long as the machine does not have obvious vibration or cutting tool without obvious damage, you can continue to use.
- The knife type is not suitable for large depth and side milling.
- Please adjust the speed, feed and cutting depth according to actual cutting conditions.
- Air blow or oil mist is recommended for good chip evacuation.

Recommended Cutting Data

FH200-R6、RN6、RH6-H

For Alloy Steels, Hardened Steel—Face Milling



Workpiece Material		Cutting Depth (mm)	Vc (m/min)	Tool Diameter (mm)	6	8	10	12	16	20
P	Alloy Steel (35-48 HRC)	ap 0.035D	60-90	n (min ⁻¹)	3200-4800	2400-3600	1900-2900	1600-2400	1200-1800	950-1450
		ae 0.5D		vf (mm/min)	2200-3000	2200-3000	2200-3000	2200-3000	2500-3500	2500-3500
H	Hardened Steel (35-63HRC)	ap 0.035D	60-90	n (min ⁻¹)	3200-4800	2400-3600	1900-2900	1600-2400	1200-1800	950-1450
		ae 0.5D		vf (mm/min)	1920-2880	1950-2920	1950-2950	1920-2880	2160-3240	2280-3480

Remarks :

- 1、Turning red is a normal phenomenon in the process of processing, As long as the machine does not have obvious vibration or cutting tool without obvious damage, you can continue to use.
- 2、The knife type is not suitable for large depth and side milling.
- 3、Please adjust the speed, feed and cutting depth according to actual cutting conditions.
- 4、Air blow or oil mist is recommended for good chip evacuation.

Programming Data

FH200-R6, RN6, RH6-H



Geometrical Parameters						Ramping Guide For Circular and Linear Ramping						
						Circular Interpolation		Linear Ramping				
diameter	Ap1 max	R	R _c	YRC	CRN	Optimal Range of Circle Diameter for A Single Pass		Calculated Length Per Ramp Angle (mm)				
[mm]	[mm]	[mm]	[mm]	[mm]	[mm]	Smallest	largest	Ramp Angle(degree)				
								1°	2°	3°	4°	5°
6	0.20	9	0.375	0.75	1.26	8.52	12.00	11.51	5.75	3.83	2.87	2.30
8	0.27	12	0.500	1.00	1.68	11.36	16.00	15.34	7.67	5.11	3.83	3.06
10	0.33	15	0.625	1.25	2.10	14.20	20.00	19.18	9.58	6.39	4.79	3.83
12	0.40	18	0.750	1.50	2.52	17.04	24.00	23.01	11.50	7.66	5.74	4.59
16	0.54	24	1.000	2.00	3.36	22.72	32.00	30.68	15.34	10.22	7.66	6.12
20	0.67	30	1.250	2.00	4.2	28.40	40.00	38.35	19.17	12.77	9.57	7.65
Recommended Percentage of Programmed Feed Rate To Use While Ramping								100%	70%	50%	30%	10%

R=the head radius size.
 YRC=distance from centreline to the crown of the R radius.
 CRN=distance from centreline to the start of the cutting edge. This dimension can also help determine the minimum circle size when helical ramping.
 R_c=the shoulder radius or radius at the corner of the cutter.

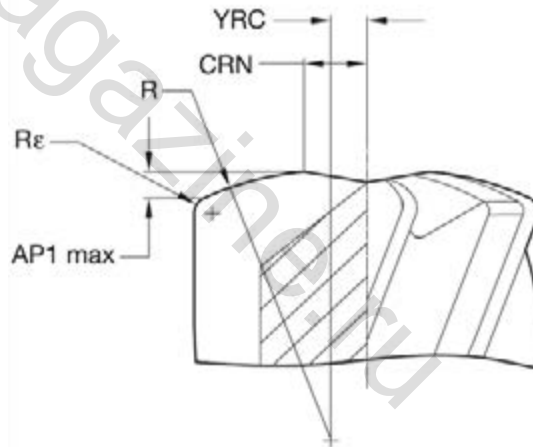

FH200-H schematic diagram of 6 flute endmill sheaar blade

Recommended Cutting Data

SHM100-SN2

For Steels, Cast Iron—Side Milling



Workpiece Material		Cutting Depth (mm)	Vc m/min	Tool Diameter (mm)	0.4	0.6	0.8	1	1.5	2
H	Alloy Steel Hardened Steel (< 55HRC)	ap≤0.7D	60	n (min-1)	47770	31850	23890	19110	12740	9550
		ae≤0.08D		vf (mm/min)	1050	890	810	880	710	630
	Alloy Steel Hardened Steel (55-60HRC)	ap≤0.5D	50	n (min-1)	39810	26540	19900	15920	10620	7960
		ae≤0.05D		vf (mm/min)	960	800	760	800	640	560

SHM100-SN2

For Steels, Cast Iron—Slotting



Workpiece Material		Cutting Depth (mm)	Vc m/min	Tool Diameter (mm)	0.4	0.6	0.8	1	1.5	2
H	Alloy Steel Hardened Steel (< 55HRC)	ap 0.1D	35	n (min-1)	27870	18580	13930	11150	7430	5570
				vf (mm/min)	450	410	390	450	370	330
	Alloy Steel Hardened Steel (55-60HRC)	ap 0.05D	30	n (min-1)	23890	15920	11940	9550	6370	4780
				vf (mm/min)	430	380	380	420	340	310

SHM100-BN2

For Steels, Cast Iron—Profiling



Workpiece Material		Cutting Depth (mm)	Vc m/min	Tool Diameter (mm)	0.4	0.6	0.8	1	1.2	1.5	2
H	Alloy Steel Hardened Steel (< 55HRC)	ap 0.03D	40	n (min-1)	31850	21230	15920	12740	10620	8490	6370
		ae 0.03D		vf (mm/min)	1150	890	760	660	640	590	570
	Alloy Steel Hardened Steel (55-60HRC)	ap 0.02D	35	n (min-1)	27870	18580	13930	11150	9290	7430	5570
		ae 0.02D		vf (mm/min)	1170	890	730	620	630	590	560

1、Maximum T.I.R. in when tool is chucked is 0.01mm(0.01mm maximum recommended).

2、Please attention to use machine and holder with high rigidity .

3、Please adjust the speed,feed and cutting depth according to actual cutting conditons.

4、The milling conditions are for an end mill where the tool overhang length is less than 4*D (mill dia).When the tool overhang length is longer, please adjust the speed,feed and cutting depth.

5、If the rpm of the machine is low,lower the feed rate also to put the rpm and feed rate in the same ratio.

Recommended Cutting Datas to General Machining

SPM200-SN2

2 Flute, Extended Neck-Square End Mill

Workpiece Materials			P						N		H			
			Carbon Steel, Alloy Steel (180 ~ 250HB)		Alloy Steels, Tool Steels (25 ~ 35HRC)		PH, Ferrite, Martensite Steels (35 ~ 45HRC)		Copper, Copper Alloys		Hardened Steels (45 ~ 55HRC)		Hardened Steels (55 ~ 65HRC)	
Ratio to standard depth of cut (ap)			1.00		0.90		0.70		1.20		0.50		0.45	
Mill Dia. (mm)	Under Neck Length (mm)	ap	n r/min	Vf mm/min	n r/min	Vf mm/min	n r/min	Vf mm/min	n r/min	Vf mm/min	n r/min	Vf mm/min	n r/min	Vf mm/min
0.1	0.3	0.006	45,000	450	45,000	428	43,740	313	50,000	500	38,475	230	36,045	187
	0.5	0.004	45,000	450	45,000	428	43,740	313	50,000	500	38,475	230	36,045	187
	1	0.003	45,000	410	43,740	387	39,330	284	50,000	455	34,650	209	32,445	168
0.2	0.5	0.02	40,500	574	36,450	517	34,425	363	45,000	637	30,375	271	28,350	218
	1	0.014	40,500	574	36,450	517	34,425	363	45,000	637	30,375	271	28,350	218
	1.5	0.008	36,450	473	32,805	425	30,983	326	43,740	567	27,338	244	25,515	196
	2	0.005	32,400	378	29,160	340	27,540	257	38,880	454	24,300	193	22,680	155
0.3	3	0.003	32,400	340	29,160	306	27,540	231	38,880	409	24,300	174	22,680	140
	1	0.021	36,000	510	32,400	459	30,600	322	43,200	612	27,000	240	25,200	194
	1.5	0.021	36,000	510	32,400	459	30,600	322	43,200	612	27,000	240	25,200	194
	2	0.012	32,400	420	29,160	378	27,540	290	38,880	504	24,300	217	22,680	175
	2.5	0.01	32,400	420	29,160	378	27,540	290	38,880	504	24,300	217	22,680	175
0.4	3	0.008	32,400	420	29,160	378	27,540	290	38,880	504	24,300	217	22,680	175
	1	0.04	28,800	635	25,920	572	24,480	401	34,560	762	21,600	300	20,160	241
	1.5	0.028	28,800	635	25,920	572	24,480	401	34,560	762	21,600	300	20,160	241
	2	0.028	28,800	635	25,920	572	24,480	401	34,560	762	21,600	300	20,160	241
	2.5	0.022	25,920	523	23,328	471	22,032	361	31,104	627	19,440	269	18,144	217
	3	0.016	25,920	523	23,328	471	22,032	361	31,104	627	19,440	269	18,144	217
	3.5	0.012	25,920	523	23,328	471	22,032	361	31,104	627	19,440	269	18,144	217
	4	0.01	25,920	523	23,328	471	22,032	361	31,104	627	19,440	269	18,144	217
	5	0.01	23,040	407	20,736	365	19,584	234	27,648	488	17,280	207	16,128	163
	6	0.006	23,040	407	20,736	365	19,584	234	27,648	488	17,280	207	16,128	163
0.5	8	0.003	20,160	310	18,144	279	17,136	180	24,192	372	15,120	155	14,112	118
	10	0.002	17,280	228	15,552	205	14,688	132	20,736	274	12,960	114	12,096	86
	1	0.05	28,800	635	25,920	572	24,480	482	34,560	762	21,600	300	20,160	241
	1.5	0.05	28,800	635	25,920	572	24,480	482	34,560	762	21,600	300	20,160	241
	2	0.035	28,800	635	25,920	572	24,480	482	34,560	762	21,600	300	20,160	241
	2.5	0.03	25,920	523	23,328	471	22,032	397	31,104	627	19,440	269	18,144	217
	3	0.02	25,920	523	23,328	471	22,032	397	31,104	627	19,440	269	18,144	217
	4	0.02	25,920	523	23,328	471	22,032	361	31,104	627	19,440	269	18,144	217
5	0.013	25,920	523	23,328	471	22,032	361	31,104	627	19,440	269	18,144	217	
6	0.013	23,040	407	20,736	365	19,584	234	27,648	488	17,280	207	16,128	163	

[Note] Please refer to P.474

Recommended Cutting Datas to General Machining

SPM200-SN2

2 Flute, Extended Neck-Square End Mill

» continue

Workpiece Materials			P						N		H			
			Carbon Steel, Alloy Steel (180 ~ 250HB)		Alloy Steels, Tool Steels (25 ~ 35HRC)		PH, Ferrite, Martensite Steels (35 ~ 45HRC)		Copper, Copper Alloys		Hardened Steels (45 ~ 55HRC)		Hardened Steels (55 ~ 65HRC)	
Ratio to standard depth of cut (ap)			1.00		0.90		0.70		1.20		0.50		0.45	
Mill Dia. (mm)	Under Neck Length (mm)	ap	n r/min	Vf mm/min	n r/min	Vf mm/min	n r/min	Vf mm/min	n r/min	Vf mm/min	n r/min	Vf mm/min	n r/min	Vf mm/min
0.5	8	0.008	23,040	348	20,736	313	19,584	222	27,648	418	17,280	175	16,128	132
	10	0.004	20,160	270	18,144	243	17,136	157	24,192	324	15,120	135	14,112	103
0.6	2	0.042	28,800	907	25,920	816	24,480	572	34,560	1,089	21,600	428	20,160	345
	3	0.035	25,920	746	23,328	671	22,032	516	31,104	896	19,440	385	18,144	311
	4	0.024	25,920	746	23,328	671	22,032	516	31,104	896	19,440	385	18,144	311
	5	0.02	25,920	746	23,328	671	22,032	516	31,104	896	19,440	385	18,144	311
	6	0.015	25,920	746	23,328	671	22,032	516	31,104	896	19,440	385	18,144	311
	7	0.015	23,040	644	20,736	580	19,584	445	27,648	773	17,280	332	16,128	268
	8	0.015	23,040	581	20,736	523	19,584	335	27,648	697	17,280	295	16,128	232
	10	0.009	23,040	581	20,736	523	19,584	335	27,648	697	17,280	295	16,128	232
0.7	2	0.07	28,800	907	25,920	816	24,480	572	34,560	1,089	21,600	428	20,160	346
	4	0.049	25,920	746	23,328	671	22,032	516	31,104	896	19,440	385	18,144	311
	6	0.018	25,920	746	23,328	671	22,032	516	31,104	896	19,440	385	18,144	311
	8	0.018	23,040	581	20,736	523	19,584	335	27,648	697	17,280	295	16,128	232
0.8	10	0.018	23,040	581	20,736	523	19,584	335	27,648	697	17,280	295	16,128	232
	4	0.056	28,800	907	25,920	816	24,480	702	34,560	1,089	21,600	619	20,160	380
	6	0.032	25,920	746	23,328	671	22,032	610	31,104	896	21,600	599	18,144	341
	8	0.02	25,920	746	23,328	671	22,032	516	31,104	896	19,440	385	18,144	311
0.9	10	0.02	23,040	581	20,736	523	19,584	335	27,648	697	17,280	295	16,128	232
	12	0.012	23,040	581	20,736	523	19,584	335	27,648	697	17,280	295	16,128	232
	6	0.036	25,920	895	23,328	806	22,032	618	31,104	985	19,440	500	18,144	373
	8	0.023	25,920	820	23,328	738	22,032	567	31,104	985	19,440	462	18,144	341
1	10	0.023	23,040	581	20,736	523	19,584	335	27,648	697	17,280	295	16,128	232
	12	0.023	23,040	581	20,736	523	19,584	335	27,648	697	17,280	295	16,128	232
	2	0.1	25,920	1,220	23,328	1,098	22,032	1,035	31,104	1,465	20,637	907	18,144	761
	3	0.085	25,920	1,220	23,328	1,098	22,032	1,035	31,104	1,465	20,637	907	18,144	761
	4	0.07	25,920	1,220	23,328	1,098	22,032	969	31,104	1,465	20,637	867	18,144	689
	5	0.055	25,920	1,220	23,328	1,098	22,032	925	31,104	1,465	20,637	784	18,144	617
1	6	0.04	23,328	1,008	20,995	907	19,829	813	27,994	1,210	18,630	671	16,330	419
	7	0.04	23,328	1,008	20,995	907	19,829	753	27,994	1,210	18,630	633	16,330	419
8	0.04	23,328	1,008	20,995	907	19,829	753	27,994	1,210	18,630	560	16,330	419	

【Note】 Please refer to P.474

Recommended Cutting Datas to General Machining

SPM200-SN2

2 Flute, Extended Neck-Square End Mill

» continue

Workpiece Materials			P						N		H			
			Carbon Steel, Alloy Steel (180 ~ 250HB)		Alloy Steels, Tool Steels (25 ~ 35HRC)		PH, Ferrite, Martensite Steels (35 ~ 45HRC)		Copper, Copper Alloys		Hardened Steels (45 ~ 55HRC)		Hardened Steels (55 ~ 65HRC)	
Ratio to standard depth of cut (ap)			1.00		0.90		0.70		1.20		0.50		0.45	
Mill Dia. (mm)	Under Neck Length (mm)	ap	n r/min	Vf mm/min	n r/min	Vf mm/min	n r/min	Vf mm/min	n r/min	Vf mm/min	n r/min	Vf mm/min	n r/min	Vf mm/min
1	9	0.033	23,328	1,008	20,995	907	19,829	696	27,994	1,210	17,496	519	16,330	419
	10	0.025	23,328	1,008	20,995	907	19,829	696	27,994	1,210	17,496	519	16,330	419
	12	0.025	20,736	784	18,662	706	17,626	452	24,883	941	15,552	399	14,515	313
	14	0.025	20,736	784	18,662	706	17,626	452	24,883	941	15,552	399	14,515	313
	16	0.015	20,736	671	18,662	605	17,626	428	24,883	806	15,552	336	14,515	255
	20	0.01	18,621	549	20,111	494	15,828	313	22,345	659	13,966	275	13,035	203
	25	0.005	15,750	427	17,010	384	13,388	243	18,900	512	11,813	213	11,025	158
1.2	6	0.084	23,040	1,089	20,736	980	19,584	783	27,648	1,307	17,280	513	16,128	414
	8	0.048	20,736	896	18,662	806	17,626	705	24,883	1,075	15,552	462	14,515	373
	10	0.03	20,736	896	18,662	806	17,626	670	24,883	1,075	15,552	462	14,515	373
	12	0.03	20,736	896	18,662	806	17,626	618	24,883	1,075	15,552	462	14,515	373
	16	0.02	18,432	796	16,589	716	15,667	550	22,118	955	13,824	410	12,902	331
1.4	6	0.1	20,160	952	18,144	858	17,136	601	24,192	1,143	15,120	449	14,112	363
	12	0.035	18,144	784	16,330	706	15,422	541	21,773	941	13,608	404	12,701	326
1.5	4	0.11	20,160	1,047	18,144	943	17,136	721	24,192	1,257	15,120	583	14,112	434
	6	0.11	20,160	1,047	18,144	943	17,136	721	24,192	1,257	15,120	561	14,112	434
	8	0.08	18,144	862	16,330	846	15,422	649	21,773	1,034	13,608	484	12,701	374
	10	0.06	18,144	784	16,330	776	15,422	649	21,773	1,034	13,608	484	12,701	374
	12	0.06	18,144	784	16,330	706	15,422	649	21,773	941	13,608	404	12,701	326
	14	0.038	18,144	784	16,330	706	15,422	649	21,773	941	13,608	404	12,701	326
	16	0.038	16,128	609	14,515	549	13,709	352	19,354	732	12,096	311	11,290	244
	18	0.038	16,128	609	14,515	549	13,709	352	19,354	732	12,096	311	11,290	244
	20	0.038	16,128	609	14,515	549	13,709	352	19,354	732	12,096	311	11,290	244
	25	0.023	12,096	392	10,886	353	10,282	250	14,515	471	9,072	196	8,467	149
	30	0.015	10,080	266	10,886	239	8,568	160	12,096	320	7,560	125	7,056	101
	35	0.01	10,080	266	10,886	239	8,568	160	12,096	320	7,560	125	7,056	101
40	0.005	8,064	142	7,258	128	6,854	86	9,677	171	6,048	67	5,645	54	
1.6	6	0.11	18,720	1,081	16,848	1,017	15,912	683	22,464	1,179	14,040	509	13,104	410
	8	0.11	18,720	1,081	16,848	885	15,912	621	22,464	1,179	14,040	509	13,104	410
1.8	6	0.13	18,720	1,081	16,848	1,061	15,912	683	22,464	1,179	14,040	556	13,104	448
	8	0.13	18,720	1,081	16,848	973	15,912	621	22,464	1,179	14,040	556	13,104	448
2	4	0.2	15,120	1,057	13,608	943	12,852	661	18,144	1,257	11,340	493	10,584	399

【Note】 Please refer to P.474

Recommended Cutting Datas to General Machining

SPM200-SN2

2 Flute, Extended Neck-Square End Mill

» continue

Workpiece Materials			P						N		H			
			Carbon Steel, Alloy Steel(180 ~ 250HB)		Alloy Steels, Tool Steels(25 ~ 35HRC)		PH, Ferrite, Martensite Steels(35 ~ 45HRC)		Copper, Copper Alloys		Hardened Steels (45 ~ 55HRC)		Hardened Steels (55 ~ 65HRC)	
Ratio to standard depth of cut(ap)			1.00		0.90		0.70		1.20		0.50		0.45	
Mill Dia. (mm)	Under Neck Length (mm)	ap	n r/min	Vf mm/min	n r/min	Vf mm/min	n r/min	Vf mm/min	n r/min	Vf mm/min	n r/min	Vf mm/min	n r/min	Vf mm/min
2	6	0.2	15,120	1,057	13,608	943	12,852	661	18,144	1,257	11,340	493	10,584	399
	8	0.14	15,120	1,057	13,608	943	12,852	661	18,144	1,257	11,340	493	10,584	399
	10	0.14	15,120	1,057	13,608	943	12,852	661	18,144	1,257	11,340	493	10,584	399
	12	0.1	13,608	862	12,247	776	11,567	595	16,330	1,034	10,206	444	9,526	358
	14	0.08	13,608	862	12,247	776	11,567	595	16,330	1,034	10,206	444	9,526	326
	16	0.08	13,608	823	12,247	776	11,567	541	16,330	941	10,206	404	9,526	326
	18	0.05	13,608	823	12,247	776	11,567	541	16,330	941	10,206	404	9,526	326
	20	0.05	13,608	784	12,247	706	11,567	541	16,330	941	10,206	404	9,526	326
	25	0.05	12,096	609	10,886	549	10,282	352	14,515	732	9,072	311	8,467	244
	30	0.03	12,096	609	10,886	549	10,282	352	14,515	732	9,072	311	8,467	244
	35	0.02	10,584	437	9,526	393	8,996	254	12,701	525	7,938	205	7,409	167
40	0.01	10,584	437	9,526	393	8,996	254	12,701	525	7,938	205	7,409	167	
50	0.005	9,072	266	8,165	239	7,711	155	10,886	320	6,804	125	6,350	101	
2.5	8	0.18	12,960	1,122	11,664	1,011	11,016	708	15,552	1,347	9,720	578	9,072	427
	12	0.18	12,960	1,122	11,664	1,011	11,016	644	15,552	1,134	9,720	529	9,072	388
	16	0.1	11,664	966	10,498	869	9,914	580	13,997	1,008	8,748	476	8,165	349
	20	0.1	11,664	840	10,498	756	9,914	580	13,997	1,008	8,748	476	8,165	349
	30	0.06	10,368	653	9,331	588	8,813	392	12,442	783	7,776	307	7,258	248
	40	0.03	9,072	469	8,165	422	7,711	282	10,886	563	6,804	221	6,350	178
50	0.01	9,072	469	8,165	422	7,711	282	10,886	563	6,804	221	6,350	178	
3	8	0.3	11,520	997	10,368	897	9,792	629	13,824	1,198	9,540	513	8,064	380
	12	0.21	11,520	997	10,368	897	9,792	629	13,824	1,198	9,540	513	8,064	380
	16	0.15	10,368	895	9,331	738	8,813	567	12,442	1,030	8,505	462	7,258	341
	20	0.12	10,368	820	9,331	738	8,813	567	12,442	896	8,505	462	7,258	341
	25	0.08	10,368	820	9,331	738	8,813	567	12,442	896	8,505	462	7,258	341
	30	0.08	10,368	746	9,331	671	8,813	567	12,442	896	8,505	462	7,258	312
	40	0.05	9,216	663	8,294	597	7,834	458	11,059	796	6,912	342	6,451	276
50	0.02	8,064	417	7,258	375	6,854	250	9,677	500	6,048	196	5,645	158	
4	12	0.4	8,460	1,692	7,614	1,372	7,191	1,222	10,350	2,070	6,345	812	5,922	655
	16	0.28	8,460	1,692	7,614	1,372	7,191	1,222	10,350	2,070	6,345	812	5,922	655
	20	0.28	7,614	1,523	6,853	1,234	6,472	1,100	9,315	1,863	5,711	731	5,330	590
	25	0.16	7,614	1,372	6,853	1,110	6,472	990	9,315	1,677	5,711	731	5,330	590

[Note] Please refer to P.474

Recommended Cutting Datas to General Machining

SPM200-SN2

2 Flute, Extended Neck-Square End Mill

» continue

Workpiece Materials			P						N		H			
			Carbon Steel, Alloy Steel (180 ~ 250HB)		Alloy Steels, Tool Steels (25 ~ 35HRC)		PH, Ferrite, Martensite Steels (35 ~ 45HRC)		Copper, Copper Alloys		Hardened Steels (45 ~ 55HRC)		Hardened Steels (55 ~ 65HRC)	
Ratio to standard depth of cut (ap)			1.00		0.90		0.70		1.20		0.50		0.45	
Mill Dia. (mm)	Under Neck Length (mm)	ap	n r/min	Vf mm/min	n r/min	Vf mm/min	n r/min	Vf mm/min	n r/min	Vf mm/min	n r/min	Vf mm/min	n r/min	Vf mm/min
4	30	0.16	7,614	1,372	6,853	1,110	6,472	990	9,315	1,677	5,711	731	5,330	590
	35	0.1	6,853	1,234	6,168	999	5,825	891	8,223	1,481	5,140	658	4,797	530
	40	0.1	6,853	1,234	6,168	999	5,825	891	8,223	1,481	5,140	658	4,797	530
	50	0.06	5,922	846	5,330	761	5,034	592	7,106	1,015	4,442	398	4,145	321
5	20	0.3	6,761	1,487	6,085	1,338	5,747	946	8,113	1,622	5,071	635	4,732	514
	25	0.3	6,084	1,216	5,476	1,094	5,171	851	7,301	1,459	4,563	572	4,259	462
	30	0.2	6,084	1,095	5,476	985	5,171	766	7,301	1,315	4,563	516	4,259	416
	40	0.15	5,476	986	4,928	887	4,654	690	6,571	1,184	4,107	464	3,833	374
	50	0.1	5,476	986	4,928	887	4,654	690	6,571	1,184	4,107	464	3,833	374
6	20	0.5	5,564	1,333	5,008	1,200	4,730	932	6,676	1,466	4,173	689	3,894	506
	30	0.4	5,058	1,211	4,552	1,091	4,299	848	6,070	1,332	3,794	626	3,541	460
	40	0.3	5,058	998	4,552	898	4,299	762	6,070	1,199	3,794	563	3,541	413
	50	0.2	4,500	887	4,050	798	3,825	621	5,400	981	3,375	464	3,150	341

【Note】

1. For different materials, adjust the cutting depth (ap) according to the cutting depth factors in the above table. E.g. for hardened steels (45 ~ 55HRC), $ap \times 0.5$.
2. Use the appropriate coolant such as air cooling or emulsion for the work material and machining shape.
3. In actual machining, the condition should be adjusted according to the machining shape, purpose and the machine type.
4. If the rpm of the machine is low, lower the feed rate also to put the rpm and feed rate in the same ratio.

Recommended Cutting Datas to High Accuracy Machining

SPM200-SN2

2 Flute, Extended Neck-Square End Mill

Workpiece Materials			P						N		H			
			Carbon Steel, Alloy Steel(180 ~ 250HB)		Alloy Steels, Tool Steels(25 ~ 35HRC)		PH, Ferrite, Martensite Steels(35 ~ 45HRC)		Copper, Copper Alloys		Hardened Steels (45 ~ 55HRC)		Hardened Steels (55 ~ 65HRC)	
Ratio to standard depth of cut(ap)			1.00		0.90		0.70		1.20		0.50		0.45	
Mill Dia. (mm)	Under Neck Length (mm)	ap	n r/min	Vf mm/min	n r/min	Vf mm/min	n r/min	Vf mm/min	n r/min	Vf mm/min	n r/min	Vf mm/min	n r/min	Vf mm/min
0.1	0.3	0.006	50,000	350	45,000	299	43,740	218	50,000	350	38,475	160	36,045	130
	0.5	0.004	50,000	350	45,000	299	43,740	218	50,000	350	38,475	160	36,045	130
	1	0.003	50,000	318	43,740	271	39,330	198	50,000	318	34,650	146	32,445	116
0.2	0.5	0.015	40,500	401	36,450	361	34,425	254	45,000	446	30,375	189	28,350	152
	1	0.011	40,500	401	36,450	361	34,425	254	45,000	446	30,375	189	28,350	152
	1.5	0.006	36,450	330	32,805	297	30,983	228	43,740	397	27,338	170	25,515	137
	2	0.004	32,400	265	29,160	238	27,540	180	38,880	317	24,300	149	22,680	132
0.3	3	0.002	32,400	238	29,160	214	27,540	161	38,880	285	24,300	149	22,680	120
	1	0.021	36,000	408	32,400	367	30,600	257	43,200	490	27,000	216	25,200	174
	1.5	0.021	36,000	408	32,400	367	30,600	257	43,200	490	27,000	216	25,200	174
	2	0.012	32,400	336	29,160	302	27,540	231	38,880	403	24,300	173	22,680	140
	2.5	0.01	32,400	336	29,160	302	27,540	231	38,880	403	24,300	173	22,680	140
0.4	3	0.008	32,400	336	29,160	302	27,540	231	38,880	403	24,300	162	22,680	131
	1	0.04	28,800	572	25,920	514	24,480	361	34,560	686	21,600	267	20,160	217
	1.5	0.028	28,800	572	25,920	514	24,480	361	34,560	686	21,600	267	20,160	217
	2	0.028	28,800	572	25,920	514	24,480	361	34,560	686	21,600	267	20,160	217
	2.5	0.022	25,920	418	23,328	376	22,032	288	31,104	501	19,440	215	18,144	173
	3	0.016	25,920	418	23,328	376	22,032	288	31,104	501	19,440	215	18,144	173
	3.5	0.012	25,920	418	23,328	376	22,032	288	31,104	501	19,440	215	18,144	173
	4	0.01	25,920	418	23,328	376	22,032	288	31,104	501	19,440	215	18,144	173
	5	0.01	23,040	284	20,736	256	19,584	187	27,648	365	17,280	166	16,128	130
0.5	6	0.006	23,040	284	20,736	256	19,584	187	27,648	365	17,280	166	16,128	130
	8	0.003	20,160	216	18,144	195	17,136	144	24,192	260	15,120	127	14,112	115
	10	0.002	17,280	159	15,552	143	14,688	105	20,736	191	12,960	93	12,096	85
	1	0.05	28,800	572	25,920	514	24,480	401	34,560	686	21,600	269	20,160	217
	1.5	0.05	28,800	572	25,920	514	24,480	401	34,560	686	21,600	269	20,160	217
	2	0.035	28,800	572	25,920	514	24,480	401	34,560	686	21,600	269	20,160	217
	2.5	0.03	25,920	418	23,328	376	22,032	319	31,104	501	19,440	215	18,144	173
	3	0.02	25,920	418	23,328	376	22,032	319	31,104	501	19,440	215	18,144	173
4	0.02	25,920	418	23,328	376	22,032	288	31,104	501	19,440	215	18,144	173	
5	0.013	25,920	418	23,328	376	22,032	288	31,104	501	19,440	215	18,144	173	
6	0.013	23,040	325	20,736	292	19,584	187	27,648	390	17,280	166	16,128	130	

【Note】 Please refer to P.479

Recommended Cutting Datas to High Accuracy Machining

SPM200-SN2

2 Flute, Extended Neck-Square End Mill

» continue

Workpiece Materials			P						N		H			
			Carbon Steel, Alloy Steel (180 ~ 250HB)		Alloy Steels, Tool Steels (25 ~ 35HRC)		PH, Ferrite, Martensite Steels (35 ~ 45HRC)		Copper, Copper Alloys		Hardened Steels (45 ~ 55HRC)		Hardened Steels (55 ~ 65HRC)	
Ratio to standard depth of cut (ap)			1.00		0.90		0.70		1.20		0.50		0.45	
Mill Dia. (mm)	Under Neck Length (mm)	ap	n r/min	Vf mm/min	n r/min	Vf mm/min	n r/min	Vf mm/min	n r/min	Vf mm/min	n r/min	Vf mm/min	n r/min	Vf mm/min
0.5	8	0.008	23,040	278	20,736	250	19,584	155	27,648	334	17,280	140	16,128	105
	10	0.004	20,160	216	18,144	194	17,136	109	24,192	259	15,120	95	14,112	71
0.6	2	0.042	28,800	816	25,920	734	24,480	515	34,560	980	21,600	384	20,160	310
	3	0.035	25,920	671	23,328	604	22,032	464	31,104	806	19,440	347	18,144	279
	4	0.024	25,920	671	23,328	604	22,032	464	31,104	806	19,440	347	18,144	279
	5	0.02	25,920	597	23,328	536	22,032	412	31,104	716	19,440	308	18,144	248
	6	0.015	25,920	597	23,328	536	22,032	412	31,104	716	19,440	308	18,144	248
	7	0.015	23,040	515	20,736	464	19,584	356	27,648	618	17,280	266	16,128	214
	8	0.015	23,040	464	20,736	418	19,584	267	27,648	536	17,280	236	16,128	185
	10	0.009	23,040	464	20,736	418	19,584	267	27,648	536	17,280	236	16,128	185
0.7	2	0.07	28,800	816	25,920	734	24,480	515	34,560	980	21,600	384	20,160	310
	4	0.049	25,920	597	23,328	536	22,032	412	31,104	716	19,440	308	18,144	248
	6	0.018	25,920	597	23,328	536	22,032	412	31,104	716	19,440	308	18,144	248
	8	0.018	23,040	406	20,736	365	19,584	234	27,648	487	17,280	206	16,128	162
	10	0.018	23,040	406	20,736	365	19,584	234	27,648	487	17,280	206	16,128	162
0.8	4	0.056	28,800	816	25,920	734	24,480	572	34,560	980	21,600	428	20,160	345
	6	0.032	25,920	597	23,328	536	22,032	516	31,104	716	19,440	385	18,144	311
	8	0.02	25,920	597	23,328	536	22,032	412	31,104	716	19,440	308	18,144	248
	10	0.02	23,040	406	20,736	365	19,584	234	27,648	487	17,280	206	16,128	162
	12	0.012	23,040	406	20,736	365	19,584	234	27,648	487	17,280	206	16,128	162
0.9	6	0.036	25,920	746	23,328	671	22,032	516	31,104	896	19,440	385	18,144	311
	8	0.023	25,920	671	23,328	671	22,032	516	31,104	896	19,440	385	18,144	311
	10	0.023	23,040	464	20,736	418	19,584	267	27,648	557	17,280	236	16,128	185
	12	0.023	23,040	406	20,736	373	19,584	267	27,648	487	17,280	236	16,128	185
1	2	0.09	25,920	1,098	23,328	988	22,032	842	31,104	1,319	19,440	629	18,144	507
	3	0.07	25,920	1,098	23,328	988	22,032	842	31,104	1,319	19,440	629	18,144	507
	4	0.065	25,920	1,098	23,328	988	22,032	842	31,104	1,319	19,440	629	18,144	507
	5	0.05	25,920	1,098	23,328	988	22,032	842	31,104	1,319	19,440	629	18,144	507
	6	0.035	23,328	907	20,995	816	19,829	696	27,994	1,148	17,496	519	16,330	376
	7	0.035	23,328	907	20,995	816	19,829	696	27,994	1,148	17,496	519	16,330	376
	8	0.035	23,328	907	20,995	816	19,829	696	27,994	1,088	17,496	519	16,330	376

【Note】 Please refer to P.479

Recommended Cutting Datas to High Accuracy Machining

SPM200-SN2

2 Flute, Extended Neck-Square End Mill

» continue

Workpiece Materials			P						N		H			
			Carbon Steel, Alloy Steel (180 ~ 250HB)		Alloy Steels, Tool Steels (25 ~ 35HRC)		PH, Ferrite, Martensite Steels (35 ~ 45HRC)		Copper, Copper Alloys		Hardened Steels (45 ~ 55HRC)		Hardened Steels (55 ~ 65HRC)	
Ratio to standard depth of cut (ap)			1.00		0.90		0.70		1.20		0.50		0.45	
Mill Dia. (mm)	Under Neck Length (mm)	ap	n r/min	Vf mm/min	n r/min	Vf mm/min	n r/min	Vf mm/min	n r/min	Vf mm/min	n r/min	Vf mm/min	n r/min	Vf mm/min
1	9	0.03	23,328	907	20,995	816	19,829	626	27,994	1,088	17,496	415	16,330	335
	10	0.022	23,328	806	20,995	734	19,829	626	27,994	1,088	17,496	415	16,330	335
	12	0.022	20,736	626	18,662	564	17,626	361	24,883	752	15,552	319	14,515	250
	14	0.022	20,736	626	18,662	564	17,626	361	24,883	752	15,552	319	14,515	250
	16	0.012	20,736	536	18,662	483	17,626	342	24,883	644	15,552	268	14,515	203
	20	0.008	18,621	439	16,759	395	15,828	250	22,345	527	13,966	192	13,035	142
	25	0.005	15,750	341	14,175	307	13,388	194	18,900	410	11,813	149	11,025	110
1.2	6	0.084	23,040	980	20,736	882	19,584	684	27,648	1,175	17,280	462	16,128	373
	8	0.048	20,736	806	18,662	725	17,626	616	24,883	967	15,552	415	14,515	335
	10	0.03	20,736	806	18,662	725	17,626	616	24,883	967	15,552	415	14,515	335
	12	0.03	20,736	644	18,662	578	17,626	494	24,883	860	15,552	369	14,515	298
	16	0.02	18,432	636	16,589	501	15,667	439	22,118	763	13,824	328	12,902	265
1.4	6	0.1	20,160	857	18,144	771	17,136	541	24,192	1,029	15,120	404	14,112	325
	12	0.035	18,144	705	16,330	635	15,422	486	21,773	846	13,608	364	12,701	293
1.5	4	0.11	20,160	952	18,144	858	17,136	601	24,192	1,143	15,120	449	14,112	362
	6	0.11	20,160	857	18,144	779	17,136	601	24,192	1,029	15,120	449	14,112	362
	8	0.06	18,144	784	16,330	706	15,422	541	21,773	941	13,608	404	12,701	326
	10	0.06	18,144	705	16,330	635	15,422	541	21,773	941	13,608	404	12,701	326
	12	0.06	18,144	705	16,330	635	15,422	541	21,773	846	13,608	364	12,701	293
	14	0.038	18,144	705	16,330	635	15,422	541	21,773	846	13,608	364	12,701	293
	16	0.038	16,128	548	14,515	494	13,709	316	19,354	658	12,096	279	11,290	219
	18	0.038	16,128	548	14,515	494	13,709	316	19,354	658	12,096	279	11,290	219
	20	0.038	16,128	548	14,515	439	13,709	281	19,354	658	12,096	248	11,290	194
	25	0.023	12,096	352	10,886	282	10,282	200	14,515	423	9,072	157	8,467	119
	30	0.015	10,080	239	10,886	191	8,568	134	12,096	287	7,560	100	7,056	80
1.6	6	0.11	18,720	879	16,848	796	15,912	621	22,464	1,061	14,040	464	13,104	374
	8	0.11	18,720	879	16,848	796	15,912	559	22,464	1,061	14,040	464	13,104	374
1.8	6	0.13	18,720	897	16,848	796	15,912	621	22,464	1,061	14,040	464	13,104	374
	8	0.13	18,720	897	16,848	796	15,912	559	22,464	1,061	14,040	464	13,104	374
2	4	0.2	15,120	857	13,608	775	12,852	590	18,144	1,143	11,340	449	10,584	362

【Note】 Please refer to P.479

Recommended Cutting Datas to High Accuracy Machining

SPM200-SN2

2 Flute, Extended Neck-Square End Mill

» continue

Workpiece Materials			P						N		H			
			Carbon Steel, Alloy Steel (180 ~ 250HB)		Alloy Steels, Tool Steels (25 ~ 35HRC)		PH, Ferrite, Martensite Steels (35 ~ 45HRC)		Copper, Copper Alloys		Hardened Steels (45 ~ 55HRC)		Hardened Steels (55 ~ 65HRC)	
Ratio to standard depth of cut (ap)			1.00		0.90		0.70		1.20		0.50		0.45	
Mill Dia. (mm)	Under Neck Length (mm)	ap	n r/min	Vf mm/min	n r/min	Vf mm/min	n r/min	Vf mm/min	n r/min	Vf mm/min	n r/min	Vf mm/min	n r/min	Vf mm/min
2	6	0.2	15,120	857	13,608	775	12,852	590	18,144	1,143	11,340	449	10,584	362
	8	0.14	15,120	857	13,608	775	12,852	590	18,144	1,143	11,340	449	10,584	362
	10	0.14	15,120	857	13,608	775	12,852	590	18,144	1,143	11,340	449	10,584	362
	12	0.08	13,608	784	12,247	706	11,567	531	16,330	941	10,206	404	9,526	326
	14	0.08	13,608	784	12,247	706	11,567	531	16,330	941	10,206	404	9,526	293
	16	0.08	13,608	705	12,247	636	11,567	486	16,330	846	10,206	383	9,526	293
	18	0.05	13,608	705	12,247	636	11,567	486	16,330	846	10,206	364	9,526	260
	20	0.05	13,608	626	12,247	564	11,567	432	16,330	799	10,206	323	9,526	260
	25	0.05	12,096	548	10,886	494	10,282	281	14,515	658	9,072	279	8,467	209
	30	0.03	12,096	487	10,886	439	10,282	246	14,515	585	9,072	248	8,467	194
	35	0.02	10,584	349	9,526	314	8,996	203	12,701	419	7,938	164	7,409	133
	40	0.01	10,584	306	9,527	275	8,996	177	12,701	367	7,938	143	7,409	116
2.5	8	0.18	12,960	1,021	11,664	919	11,016	644	15,552	1,225	9,720	482	9,072	388
	12	0.18	12,960	918	11,664	840	11,016	580	15,552	1,021	9,720	468	9,072	348
	16	0.1	11,664	755	10,498	682	9,914	521	13,997	907	8,748	405	8,165	314
	20	0.1	11,664	715	10,498	640	9,914	464	13,997	756	8,748	405	8,165	279
	30	0.06	10,368	522	9,331	411	8,813	313	12,442	626	7,776	245	7,258	198
	40	0.03	9,072	328	8,165	295	7,711	225	10,886	393	6,804	176	6,350	142
3	50	0.01	9,072	304	8,165	274	7,711	183	10,886	338	6,804	154	6,350	124
	8	0.3	11,520	907	10,368	816	9,792	572	13,824	1,089	8,640	428	8,064	345
	12	0.21	11,520	907	10,368	816	9,792	572	13,824	1,089	8,640	428	8,064	345
	16	0.12	10,368	746	9,331	671	8,813	516	12,442	896	7,776	385	7,258	310
	20	0.12	10,368	708	9,331	635	8,813	516	12,442	806	7,776	385	7,258	310
	25	0.08	10,368	708	9,331	635	8,813	516	12,442	806	7,776	385	7,258	310
	30	0.08	10,368	597	9,331	541	8,813	516	12,442	716	7,776	385	7,258	279
	40	0.05	9,216	464	8,294	418	7,834	320	11,059	556	6,912	274	6,451	221
4	50	0.02	8,064	312	7,258	262	6,854	175	9,677	350	6,048	137	5,645	111
	12	0.4	8,460	1,523	7,614	1,233	7,191	1,100	10,350	1,863	6,345	730	5,922	589
	16	0.28	8,460	1,523	7,614	1,233	7,191	1,100	10,350	1,863	6,345	730	5,922	589
	20	0.28	7,614	1,370	6,853	1,110	6,472	989	9,315	1,677	5,711	657	5,330	529
	25	0.16	7,614	1,233	6,853	998	6,472	891	9,315	1,508	5,711	657	5,330	529

[Note] Please refer to P.479

Recommended Cutting Datas to High Accuracy Machining

SPM200-SN2

2 Flute, Extended Neck-Square End Mill

» continue

Workpiece Materials			P						N		H			
			Carbon Steel, Alloy Steel (180 ~ 250HB)		Alloy Steels, Tool Steels (25 ~ 35HRC)		PH, Ferrite, Martensite Steels (35 ~ 45HRC)		Copper, Copper Alloys		Hardened Steels (45 ~ 55HRC)		Hardened Steels (55 ~ 65HRC)	
Ratio to standard depth of cut (ap)			1.00		0.90		0.70		1.20		0.50		0.45	
Mill Dia. (mm)	Under Neck Length (mm)	ap	n r/min	Vf mm/min	n r/min	Vf mm/min	n r/min	Vf mm/min	n r/min	Vf mm/min	n r/min	Vf mm/min	n r/min	Vf mm/min
4	30	0.16	7,614	1,233	6,853	998	6,472	792	9,315	1,508	5,711	584	5,330	529
	35	0.1	6,853	986	6,168	799	5,825	713	8,223	1,184	5,140	526	4,797	424
	40	0.1	6,853	863	6,168	699	5,825	624	8,223	1,036	5,140	460	4,797	371
	50	0.06	5,922	592	6,395	533	5,034	414	7,106	710	4,442	278	4,145	224
5	20	0.3	6,761	1,216	6,085	1,094	5,747	851	8,113	1,459	5,071	572	4,732	462
	25	0.3	6,084	1,094	5,476	985	5,171	765	7,301	1,312	4,563	514	4,259	415
	30	0.2	6,084	985	5,476	886	5,171	689	7,301	1,182	4,563	463	4,259	374
	40	0.15	5,476	788	4,928	709	4,654	552	6,571	947	4,107	371	3,833	299
	50	0.1	5,476	788	4,928	621	4,654	518	6,571	887	4,107	324	3,833	262
6	20	0.5	5,564	1,111	5,008	1,000	4,730	778	6,676	1,333	4,173	522	3,894	422
	30	0.4	5,058	1,010	4,552	909	4,299	707	6,070	1,211	3,794	474	3,541	383
	40	0.3	5,058	908	4,552	817	4,299	635	6,070	1,090	3,794	427	3,541	345
	50	0.2	4,500	735	4,050	662	3,825	572	5,400	883	3,375	384	3,150	311

【Note】

- For different materials, adjust the cutting depth (ap) according to the cutting depth factors in the above table. E.g. for hardened steels (45 ~ 55HRC), ap*0.5.
- Use the appropriate coolant such as air cooling or emulsion for the work material and machining shape.
- In actual machining, the condition should be adjusted according to the machining shape, purpose and the machine type.
- If the rpm of the machine is low, lower the feed rate also to put the rpm and feed rate in the same ratio.

Recommended Cutting Datas to General Machining

SPM200-RN2

2 Flute, Extended Neck-Corner Radius End Mill

Workpiece Materials				P						N		H			
				Carbon Steel, Alloy Steel (180 ~ 250HB)		Alloy Steels, Tool Steels (25 ~ 35HRC)		PH, Ferrite, Martensite Steels (35 ~ 45HRC)		Copper, Copper Alloys		Hardened Steels (45 ~ 55HRC)		Hardened Steels (55 ~ 65HRC)	
Ratio to standard depth of cut (ap)				1.00		0.90		0.70		1.20		0.50		0.45	
Mill Dia. (mm)	r (mm)	Under Neck Length (mm)	ap	n r/min	Vf mm/min	n r/min	Vf mm/min	n r/min	Vf mm/min	n r/min	Vf mm/min	n r/min	Vf mm/min	n r/min	Vf mm/min
0.2	0.02	0.5	0.016	45,000	830	40,500	746	38,250	635	45,000	830	33,750	498	31,500	407
		1	0.011	45,000	830	40,500	746	38,250	635	45,000	830	33,750	498	31,500	407
		2	0.007	37,800	697	36,450	671	34,425	572	45,000	728	30,375	448	28,350	365
	0.05	0.5	0.02	45,000	830	40,500	746	38,250	635	45,000	830	33,750	498	31,500	407
		1	0.014	45,000	830	40,500	746	38,250	635	45,000	830	33,750	498	31,500	407
		1.5	0.008	42,300	779	38,475	709	36,338	603	45,000	728	32,063	473	29,925	386
	2	0.008	37,800	697	36,450	671	34,425	572	45,000	728	30,375	448	28,350	365	
0.3	0.02	1	0.016	43,200	1,045	38,880	941	36,720	660	45,000	1,087	32,400	492	30,240	397
		2	0.011	34,992	774	31,493	697	29,743	535	40,500	898	26,244	399	24,494	321
		3	0.007	33,242	684	29,918	616	28,256	473	38,475	793	24,932	353	23,270	284
	0.05	1	0.021	43,200	1,045	38,880	941	36,720	660	45,000	1,087	32,400	492	30,240	397
		1.5	0.016	41,040	993	36,936	894	34,884	627	42,750	1,032	30,780	468	28,728	377
		2	0.012	34,992	774	31,493	697	29,743	535	40,500	898	26,244	399	24,494	321
		2.5	0.01	34,992	774	31,493	697	29,743	535	40,500	898	26,244	399	24,494	321
		3	0.008	33,242	684	29,918	616	28,256	473	38,475	793	24,932	353	23,270	284
0.4	0.02	1	0.016	34,470	929	31,104	836	29,030	714	41,472	1,115	25,920	558	24,053	457
		2	0.013	34,470	836	31,104	752	29,030	643	41,472	1,004	25,920	501	24,053	411
		3	0.01	26,393	584	23,793	527	22,208	449	31,725	702	19,828	351	18,401	288
		4	0.007	21,735	482	19,595	433	18,288	370	26,126	578	16,329	289	15,153	237
	0.05	1	0.025	34,470	929	31,104	836	29,030	714	41,472	1,115	25,920	558	24,053	457
		1.5	0.02	34,470	929	31,104	836	29,030	714	41,472	1,115	25,920	558	24,053	457
		2	0.016	34,470	836	31,104	752	29,030	643	41,472	1,004	25,920	501	24,053	411
		2.5	0.015	32,400	797	29,160	716	27,540	609	38,880	956	24,300	478	22,680	391
		3	0.014	26,393	584	23,793	527	22,208	449	31,725	702	19,828	351	18,401	288
		3.5	0.012	24,786	548	22,307	493	21,068	420	29,743	658	18,590	329	17,350	269
	0.1	4	0.008	21,735	482	19,595	433	18,288	370	26,126	578	16,329	289	15,153	237
		1	0.033	34,470	929	31,104	836	29,030	714	41,472	1,115	25,920	558	24,053	457
2		0.028	34,470	836	31,104	752	29,030	643	41,472	1,004	25,920	501	24,053	411	
3		0.016	26,393	584	23,793	527	22,208	449	31,725	702	19,828	351	18,401	288	
0.5	0.02	4	0.01	21,735	482	19,595	433	18,288	370	26,126	578	16,329	289	15,153	237
		1	0.016	34,470	929	31,104	836	29,030	714	41,472	1,115	25,920	558	24,053	457
		2	0.013	34,470	929	31,104	836	29,030	714	41,472	1,115	25,920	558	24,053	457

[Note] Please refer to P.490

Recommended Cutting Datas to General Machining

SPM200-RN2

2 Flute, Extended Neck-Corner Radius End Mill

» continue

Workpiece Materials				P						N		H				
				Carbon Steel, Alloy Steel (180 ~ 250HB)		Alloy Steels, Tool Steels (25 ~ 35HRC)		PH, Ferrite, Martensite Steels (35 ~ 45HRC)		Copper, Copper Alloys		Hardened Steels (45 ~ 55HRC)		Hardened Steels (55 ~ 65HRC)		
Ratio to standard depth of cut (ap)				1.00		0.90		0.70		1.20		0.50		0.45		
Mill Dia. (mm)	r (mm)	Under Neck Length (mm)	ap	n r/min	Vf mm/min	n r/min	Vf mm/min	n r/min	Vf mm/min	n r/min	Vf mm/min	n r/min	Vf mm/min	n r/min	Vf mm/min	
0.5	0.02	3	0.01	27,994	755	25,195	675	23,794	571	33,593	900	20,995	426	19,596	343	
		4	0.008	24,883	671	22,395	599	21,151	507	29,860	800	18,662	378	17,419	305	
		6	0.006	19,354	500	17,419	449	16,450	288	23,225	599	14,515	254	13,548	200	
	0.05	1	0.03	34,470	929	31,104	836	29,030	714	41,472	1,115	25,920	558	24,053	457	
		2	0.023	34,470	929	31,104	836	29,030	714	41,472	1,115	25,920	558	24,053	457	
		3	0.017	27,994	755	25,195	675	23,794	571	33,593	900	20,995	426	19,596	343	
		4	0.017	24,883	671	22,395	599	21,151	507	29,860	800	18,662	378	17,419	305	
		5	0.011	21,773	588	19,596	525	18,507	444	26,127	700	16,330	331	15,241	267	
		6	0.008	19,354	500	17,419	449	16,450	288	23,225	599	14,515	254	13,548	200	
	0.1	1	0.035	34,470	929	31,104	836	29,030	714	41,472	1,115	25,920	558	24,053	457	
		2	0.03	34,470	929	31,104	836	29,030	714	41,472	1,115	25,920	558	24,053	457	
		3	0.02	27,994	755	25,195	675	23,794	571	33,593	900	20,995	426	19,596	343	
		4	0.02	24,883	671	22,395	599	21,151	507	29,860	800	18,662	378	17,419	305	
		5	0.013	21,773	588	19,596	525	18,507	444	26,127	700	16,330	331	15,241	267	
		6	0.013	19,354	500	17,419	449	16,450	288	23,225	599	14,515	254	13,548	200	
	0.6	0.02	2	0.016	34,470	1,310	31,104	1,182	29,030	892	41,472	1,576	25,920	697	24,053	572
			4	0.013	27,994	1,032	25,195	929	23,794	713	33,593	1,238	20,995	532	19,596	429
			6	0.01	21,773	803	19,596	723	18,507	554	26,127	963	16,330	414	15,241	334
0.05		2	0.028	34,470	1,310	31,104	1,182	29,030	892	41,472	1,576	25,920	697	24,053	572	
		4	0.019	27,994	1,032	25,195	929	23,794	713	33,593	1,238	20,995	532	19,596	429	
		6	0.012	21,773	803	19,596	723	18,507	554	26,127	963	16,330	414	15,241	334	
		8	0.01	20,684	762	18,616	687	17,582	527	24,821	915	15,513	393	14,479	317	
		10	0.007	18,507	610	16,656	549	15,731	440	22,208	733	13,880	320	12,955	258	
		10	0.009	18,507	610	16,656	549	15,731	440	22,208	733	13,880	320	12,955	258	
0.1		2	0.035	34,470	1,310	31,104	1,182	29,030	892	41,472	1,576	25,920	697	24,053	572	
		4	0.024	27,994	1,032	25,195	929	23,794	713	33,593	1,238	20,995	532	19,596	429	
		6	0.015	21,773	803	19,596	723	18,507	554	26,127	963	16,330	414	15,241	334	
		8	0.013	20,684	762	18,616	687	17,582	527	24,821	915	15,513	393	14,479	317	
		10	0.009	18,507	610	16,656	549	15,731	440	22,208	733	13,880	320	12,955	258	
		10	0.009	18,507	610	16,656	549	15,731	440	22,208	733	13,880	320	12,955	258	
0.7	0.05	4	0.024	27,994	1,032	25,195	929	23,794	713	33,593	1,238	20,995	532	19,596	429	
		6	0.015	21,773	803	19,596	723	18,507	554	26,127	963	16,330	414	15,241	334	
	0.1	4	0.029	27,994	1,032	25,195	929	23,794	713	33,593	1,238	20,995	532	19,596	429	
		6	0.018	21,773	803	19,596	723	18,507	554	26,127	963	16,330	414	15,241	334	

[Note] Please refer to P.490

Recommended Cutting Datas to General Machining

SPM200-RN2

2 Flute, Extended Neck-Corner Radius End Mill

» continue

Workpiece Materials				P						N		H			
				Carbon Steel, Alloy Steel (180 ~ 250HB)		Alloy Steels, Tool Steels (25 ~ 35HRC)		PH, Ferrite, Martensite Steels (35 ~ 45HRC)		Copper, Copper Alloys		Hardened Steels (45 ~ 55HRC)		Hardened Steels (55 ~ 65HRC)	
Ratio to standard depth of cut (ap)				1.00		0.90		0.70		1.20		0.50		0.45	
Mill Dia. (mm)	r (mm)	Under Neck Length (mm)	ap	n r/min	Vf mm/min	n r/min	Vf mm/min	n r/min	Vf mm/min	n r/min	Vf mm/min	n r/min	Vf mm/min	n r/min	Vf mm/min
0.8	0.02	4	0.016	36,000	1,328	32,400	1,194	30,600	1,015	43,200	1,592	27,000	797	25,200	651
		6	0.013	27,540	914	24,786	823	23,409	777	33,048	1,096	20,655	609	19,278	498
	0.05	4	0.026	36,000	1,328	32,400	1,194	30,600	1,015	43,200	1,592	27,000	797	25,200	651
		6	0.015	27,540	914	24,786	823	23,409	777	33,048	1,096	20,655	609	19,278	498
		8	0.012	22,032	680	19,829	612	18,727	578	26,438	815	16,524	454	15,422	370
		12	0.01	19,829	569	17,846	512	16,854	483	23,794	683	14,872	379	13,880	310
	0.1	4	0.032	36,000	1,328	32,400	1,194	30,600	1,015	43,200	1,592	27,000	797	25,200	651
		6	0.019	27,540	914	24,786	823	23,409	777	33,048	1,096	20,655	609	19,278	498
		8	0.015	22,032	680	19,829	612	18,727	578	26,438	815	16,524	454	15,422	370
		12	0.012	19,829	569	17,846	512	16,854	483	23,794	683	14,872	379	13,880	310
	0.2	4	0.056	36,000	1,328	32,400	1,194	30,600	1,015	43,200	1,592	27,000	797	25,200	651
		6	0.032	27,540	914	24,786	823	23,409	777	33,048	1,096	20,655	609	19,278	498
8		0.018	22,032	680	19,829	612	18,727	578	26,438	815	16,524	454	15,422	370	
12		0.015	19,829	569	17,846	512	16,854	483	23,794	683	14,872	379	13,880	310	
1	0.02	2	0.016	35,541	2,132	32,101	1,926	30,095	1,625	42,993	2,579	26,655	1,279	24,936	1,047
		4	0.013	32,400	1,941	29,160	1,747	27,540	1,485	38,880	2,329	24,300	1,165	22,680	951
		6	0.01	26,244	1,415	26,369	1,581	22,307	1,202	31,493	1,698	19,683	943	18,371	770
		8	0.008	23,328	1,257	23,620	1,274	19,829	1,069	27,994	1,509	17,496	839	16,330	685
		10	0.006	20,412	1,101	20,995	1,132	17,350	935	24,494	1,320	15,309	734	14,288	599
		12	0.005	18,144	869	18,371	990	15,422	647	21,773	1,043	13,608	571	12,701	456
	0.05	2	0.046	35,541	2,132	32,101	1,926	30,095	1,625	42,993	2,579	26,655	1,279	24,936	1,047
		3	0.035	35,541	2,132	32,101	1,926	30,095	1,625	42,993	2,579	26,655	1,279	24,936	1,047
		4	0.027	32,400	1,941	29,160	1,747	27,540	1,485	38,880	2,329	24,300	1,165	22,680	951
		5	0.021	28,662	1,719	26,369	1,581	24,936	1,346	35,827	2,149	22,070	1,059	20,636	867
		6	0.017	26,244	1,415	23,620	1,274	22,307	1,202	31,493	1,698	19,683	943	18,371	770
		8	0.016	23,328	1,257	20,995	1,132	19,829	1,069	27,994	1,509	17,496	839	16,330	685
10		0.011	20,412	1,101	18,371	990	17,350	935	24,494	1,320	15,309	734	14,288	599	
12		0.01	18,144	869	16,330	783	15,422	647	21,773	1,043	13,608	571	12,701	456	
0.1	2	0.065	35,541	2,132	32,101	1,926	30,095	1,625	42,993	2,579	26,655	1,279	24,936	1,047	
	3	0.05	35,541	2,132	32,101	1,926	30,095	1,625	42,993	2,579	26,655	1,279	24,936	1,047	

[Note] Please refer to P.490

Recommended Cutting Datas to General Machining

SPM200-RN2

2 Flute, Extended Neck-Corner Radius End Mill

» continue

Workpiece Materials				P						N		H				
				Carbon Steel, Alloy Steel(180 ~ 250HB)		Alloy Steels, Tool Steels(25 ~ 35HRC)		PH, Ferrite, Martensite Steels(35 ~ 45HRC)		Copper, Copper Alloys		Hardened Steels (45 ~ 55HRC)		Hardened Steels (55 ~ 65HRC)		
Ratio to standard depth of cut(ap)				1.00		0.90		0.70		1.20		0.50		0.45		
Mill Dia. (mm)	r (mm)	Under Neck Length (mm)	ap	n r/min	Vf mm/min	n r/min	Vf mm/min	n r/min	Vf mm/min	n r/min	Vf mm/min	n r/min	Vf mm/min	n r/min	Vf mm/min	
1	0.1	4	0.038	32,400	1,941	29,160	1,747	27,540	1,485	38,880	2,329	24,300	1,165	22,680	951	
		5	0.03	28,662	1,719	26,369	1,581	24,936	1,346	35,827	2,149	22,070	1,059	20,636	867	
		6	0.024	26,244	1,415	23,620	1,274	22,307	1,202	31,493	1,698	19,683	943	18,371	770	
		8	0.024	23,328	1,257	20,995	1,132	19,829	1,069	27,994	1,509	17,496	839	16,330	685	
		10	0.015	20,412	1,101	18,371	990	17,350	935	24,494	1,320	15,309	734	14,288	599	
		12	0.015	18,144	869	16,330	783	15,422	647	21,773	1,043	13,608	571	12,701	456	
		16	0.009	18,144	761	16,330	685	15,422	600	21,773	913	13,608	489	12,701	381	
		20	0.006	13,608	571	12,247	514	11,567	450	16,330	685	10,206	367	9,526	285	
	0.2	2	0.11	35,541	2,132	32,101	1,926	30,095	1,625	42,993	2,579	26,655	1,279	24,936	1,047	
		3	0.09	35,541	2,132	32,101	1,926	30,095	1,625	42,993	2,579	26,655	1,279	24,936	1,047	
		4	0.07	32,400	1,941	29,160	1,747	27,540	1,485	38,880	2,329	24,300	1,165	22,680	951	
		5	0.05	28,662	1,719	26,369	1,581	24,936	1,346	35,827	2,149	22,070	1,059	20,636	867	
		6	0.04	26,244	1,415	23,620	1,274	22,307	1,202	31,493	1,698	19,683	943	18,371	770	
		8	0.04	23,328	1,257	20,995	1,132	19,829	1,069	27,994	1,509	17,496	839	16,330	685	
		10	0.025	20,412	1,101	18,371	990	17,350	935	24,494	1,320	15,309	734	14,288	599	
		12	0.025	18,144	869	16,330	783	15,422	647	21,773	1,043	13,608	571	12,701	456	
	0.3	16	0.015	18,144	761	16,330	685	15,422	600	21,773	913	13,608	489	12,701	381	
		20	0.01	13,608	571	12,247	514	11,567	450	16,330	685	10,206	367	9,526	285	
		2	0.11	35,541	2,132	32,101	1,926	30,095	1,625	42,993	2,579	26,655	1,279	24,936	1,047	
		3	0.09	35,541	2,132	32,101	1,926	30,095	1,625	42,993	2,579	26,655	1,279	24,936	1,047	
		4	0.07	32,400	1,941	29,160	1,747	27,540	1,485	38,880	2,329	24,300	1,165	22,680	951	
		5	0.05	28,662	1,719	26,369	1,581	24,936	1,346	35,827	2,149	22,070	1,059	20,636	867	
		6	0.04	26,244	1,415	23,620	1,274	22,307	1,202	31,493	1,698	19,683	943	18,371	770	
		8	0.04	23,328	1,257	20,995	1,132	19,829	1,069	27,994	1,509	17,496	839	16,330	685	
	1.25	0.1	5	0.03	28,662	1,719	26,369	1,581	24,936	1,346	35,827	2,149	22,070	1,059	20,636	867
			10	0.015	23,328	1,257	18,371	990	17,350	935	24,494	1,320	15,309	734	14,288	599
			15	0.01	18,144	761	16,330	685	15,422	600	21,773	913	13,608	489	12,701	381
			20	0.006	13,608	571	12,247	514	11,567	450	16,330	685	10,206	367	9,526	285

【Note】 Please refer to P.490

Recommended Cutting Datas to General Machining

SPM200-RN2

2 Flute, Extended Neck-Corner Radius End Mill

» continue

Workpiece Materials				P						N		H			
				Carbon Steel, Alloy Steel (180 ~ 250HB)		Alloy Steels, Tool Steels (25 ~ 35HRC)		PH, Ferrite, Martensite Steels (35 ~ 45HRC)		Copper, Copper Alloys		Hardened Steels (45 ~ 55HRC)		Hardened Steels (55 ~ 65HRC)	
Ratio to standard depth of cut (ap)				1.00		0.90		0.70		1.20		0.50		0.45	
Mill Dia. (mm)	r (mm)	Under Neck Length (mm)	ap	n r/min	Vf mm/min	n r/min	Vf mm/min	n r/min	Vf mm/min	n r/min	Vf mm/min	n r/min	Vf mm/min	n r/min	Vf mm/min
1.25	0.2	5	0.05	28,662	1,719	26,369	1,581	24,936	1,346	35,827	2,149	22,070	1,059	20,636	867
		10	0.025	23,328	1,257	18,371	990	17,350	935	24,494	1,320	15,309	734	14,288	599
		15	0.016	18,144	761	16,330	685	15,422	600	21,773	913	13,608	489	12,701	381
		20	0.01	13,608	571	12,247	514	11,567	450	16,330	685	10,206	367	9,526	285
	0.3	5	0.05	28,662	1,719	26,369	1,581	24,936	1,346	35,827	2,149	22,070	1,059	20,636	867
		10	0.025	23,328	1,257	18,371	990	17,350	935	24,494	1,320	15,309	734	14,288	599
		15	0.016	18,144	761	16,330	685	15,422	600	21,773	913	13,608	489	12,701	381
		20	0.01	13,608	571	12,247	514	11,567	450	16,330	685	10,206	367	9,526	285
1.5	0.1	4	0.042	24,930	1,614	22,453	1,453	20,957	1,240	29,938	1,938	18,711	968	17,364	795
		6	0.04	23,885	1,543	21,401	1,382	20,255	1,199	28,662	1,851	17,961	930	16,624	761
		8	0.036	22,680	1,467	20,412	1,320	19,278	1,141	27,216	1,760	17,010	881	15,876	726
		12	0.036	18,144	1,174	16,330	1,057	15,422	913	21,773	1,409	13,608	705	12,701	581
		15	0.023	14,112	812	12,701	731	11,995	604	16,934	974	10,584	533	9,878	426
		20	0.018	14,112	734	12,701	660	11,995	552	16,934	880	10,584	486	9,878	385
	0.2	4	0.07	24,930	1,614	22,453	1,453	20,957	1,240	29,938	1,938	18,711	968	17,364	795
		6	0.065	23,885	1,543	21,401	1,382	20,255	1,199	28,662	1,851	17,961	930	16,624	761
		8	0.06	22,680	1,467	20,412	1,320	19,278	1,141	27,216	1,760	17,010	881	15,876	726
		12	0.06	18,144	1,174	16,330	1,057	15,422	913	21,773	1,409	13,608	705	12,701	581
		15	0.038	14,112	812	12,701	731	11,995	604	16,934	974	10,584	533	9,878	426
		20	0.03	14,112	734	12,701	660	11,995	552	16,934	880	10,584	486	9,878	385
	0.3	4	0.07	24,930	1,614	22,453	1,453	20,957	1,240	29,938	1,938	18,711	968	17,364	795
		6	0.065	23,885	1,543	21,401	1,382	20,255	1,199	28,662	1,851	17,961	930	16,624	761
		8	0.06	22,680	1,467	20,412	1,320	19,278	1,141	27,216	1,760	17,010	881	15,876	726
		12	0.06	18,144	1,174	16,330	1,057	15,422	913	21,773	1,409	13,608	705	12,701	581
		15	0.038	14,112	812	12,701	731	11,995	604	16,934	974	10,584	533	9,878	426
		20	0.03	14,112	734	12,701	660	11,995	552	16,934	880	10,584	486	9,878	385
	0.5	4	0.085	24,930	1,614	22,453	1,453	20,957	1,240	29,938	1,938	18,711	968	17,364	795
		6	0.08	23,885	1,543	21,401	1,382	20,255	1,199	28,662	1,851	17,961	930	16,624	761
		8	0.07	22,680	1,467	20,412	1,320	19,278	1,141	27,216	1,760	17,010	881	15,876	726
		12	0.065	18,144	1,174	16,330	1,057	15,422	913	21,773	1,409	13,608	705	12,701	581
		15	0.045	14,112	812	12,701	731	11,995	604	16,934	974	10,584	533	9,878	426
		20	0.035	14,112	734	12,701	660	11,995	552	16,934	880	10,584	486	9,878	385

[Note] Please refer to P.490

Recommended Cutting Datas to General Machining

SPM200-RN2

2 Flute, Extended Neck-Corner Radius End Mill

» continue

Workpiece Materials				P						N		H			
				Carbon Steel, Alloy Steel (180 ~ 250HB)		Alloy Steels, Tool Steels (25 ~ 35HRC)		PH, Ferrite, Martensite Steels (35 ~ 45HRC)		Copper, Copper Alloys		Hardened Steels (45 ~ 55HRC)		Hardened Steels (55 ~ 65HRC)	
Ratio to standard depth of cut (ap)				1.00		0.90		0.70		1.20		0.50		0.45	
Mill Dia. (mm)	r (mm)	Under Neck Length (mm)	ap	n r/min	Vf mm/min	n r/min	Vf mm/min	n r/min	Vf mm/min	n r/min	Vf mm/min	n r/min	Vf mm/min	n r/min	Vf mm/min
1.75	0.1	5	0.04	23,885	1,543	21,401	1,382	20,255	1,199	28,662	1,851	17,961	930	16,624	761
		10	0.036	18,144	1,174	16,330	1,057	15,422	913	21,773	1,409	13,608	705	12,701	581
		15	0.023	14,112	812	12,701	731	11,995	604	16,934	974	10,584	533	9,878	426
		20	0.018	14,112	734	12,701	660	11,995	552	16,934	880	10,584	486	9,878	385
	0.2	5	0.065	23,885	1,543	21,401	1,382	20,255	1,199	28,662	1,851	17,961	930	16,624	761
		10	0.06	18,144	1,174	16,330	1,057	15,422	913	21,773	1,409	13,608	705	12,701	581
		15	0.038	14,112	812	12,701	731	11,995	604	16,934	974	10,584	533	9,878	426
		20	0.03	14,112	734	12,701	660	11,995	552	16,934	880	10,584	486	9,878	385
	0.3	5	0.065	23,885	1,543	21,401	1,382	20,255	1,199	28,662	1,851	17,961	930	16,624	761
		10	0.06	18,144	1,174	16,330	1,057	15,422	913	21,773	1,409	13,608	705	12,701	581
		15	0.038	14,112	812	12,701	731	11,995	604	16,934	974	10,584	533	9,878	426
		20	0.03	14,112	734	12,701	660	11,995	552	16,934	880	10,584	486	9,878	385
2	0.1	4	0.08	21,783	2,448	19,634	2,207	18,487	2,077	25,796	2,899	16,337	1,467	15,334	1,205
		6	0.07	20,790	2,336	18,711	2,102	17,672	1,985	24,948	2,803	15,593	1,401	14,553	1,144
		8	0.055	18,900	2,123	17,010	1,911	16,065	1,805	22,680	2,547	14,175	1,274	13,230	1,040
		12	0.03	15,309	1,548	13,778	1,393	13,013	1,316	18,371	1,857	11,482	1,031	10,716	842
		16	0.03	13,608	1,375	12,247	1,238	11,567	1,169	16,330	1,651	10,206	917	9,526	749
		20	0.025	11,907	1,203	10,716	1,084	10,121	1,023	14,288	1,445	8,931	721	8,335	588
		25	0.015	11,907	1,203	10,716	1,084	10,121	1,023	14,288	1,445	8,931	721	8,335	588
		30	0.01	11,312	1,144	10,181	1,029	9,615	972	13,574	1,373	8,483	685	7,918	559
	0.2	4	0.1	21,783	2,448	19,634	2,207	18,487	2,077	25,796	2,899	16,337	1,467	15,334	1,205
		6	0.08	20,790	2,336	18,711	2,102	17,672	1,985	24,948	2,803	15,593	1,401	14,553	1,144
		8	0.07	18,900	2,123	17,010	1,911	16,065	1,805	22,680	2,547	14,175	1,274	13,230	1,040
		12	0.04	15,309	1,548	13,778	1,393	13,013	1,316	18,371	1,857	11,482	1,031	10,716	842
		16	0.04	13,608	1,375	12,247	1,238	11,567	1,169	16,330	1,651	10,206	917	9,526	749
		20	0.035	11,907	1,203	10,716	1,084	10,121	1,023	14,288	1,445	8,931	721	8,335	588
		25	0.025	11,907	1,203	10,716	1,084	10,121	1,023	14,288	1,445	8,931	721	8,335	588
		30	0.017	11,312	1,144	10,181	1,029	9,615	972	13,574	1,373	8,483	685	7,918	559
	0.3	4	0.13	21,783	2,448	19,634	2,207	18,487	2,077	25,796	2,899	16,337	1,467	15,334	1,205
		6	0.11	20,790	2,336	18,711	2,102	17,672	1,985	24,948	2,803	15,593	1,401	14,553	1,144
		8	0.09	18,900	2,123	17,010	1,911	16,065	1,805	22,680	2,547	14,175	1,274	13,230	1,040
		12	0.06	15,309	1,548	13,778	1,393	13,013	1,316	18,371	1,857	11,482	1,031	10,716	842

[Note] Please refer to P.490

Recommended Cutting Datas to General Machining

SPM200-RN2

2 Flute, Extended Neck-Corner Radius End Mill

» continue

Workpiece Materials				P						N		H				
				Carbon Steel, Alloy Steel (180 ~ 250HB)		Alloy Steels, Tool Steels (25 ~ 35HRC)		PH, Ferrite, Martensite Steels (35 ~ 45HRC)		Copper, Copper Alloys		Hardened Steels (45 ~ 55HRC)		Hardened Steels (55 ~ 65HRC)		
Ratio to standard depth of cut (ap)				1.00		0.90		0.70		1.20		0.50		0.45		
Mill Dia. (mm)	r (mm)	Under Neck Length (mm)	ap	n r/min	Vf mm/min	n r/min	Vf mm/min	n r/min	Vf mm/min	n r/min	Vf mm/min	n r/min	Vf mm/min	n r/min	Vf mm/min	
2	0.3	16	0.06	13,608	1,375	12,247	1,238	11,567	1,169	16,330	1,651	10,206	917	9,526	749	
		20	0.037	11,907	1,203	10,716	1,084	10,121	1,023	14,288	1,445	8,931	721	8,335	588	
		25	0.03	11,907	1,203	10,716	1,084	10,121	1,023	14,288	1,445	8,931	721	8,335	588	
		30	0.021	11,312	1,144	10,181	1,029	9,615	972	13,574	1,373	8,483	685	7,918	559	
	0.5	6	0.17	20,790	2,336	18,711	2,102	17,672	1,985	24,948	2,803	15,593	1,401	14,553	1,144	
		8	0.14	18,900	2,123	17,010	1,911	16,065	1,805	22,680	2,547	14,175	1,274	13,230	1,040	
		12	0.08	15,309	1,548	13,778	1,393	13,013	1,316	18,371	1,857	11,482	1,031	10,716	842	
		16	0.08	13,608	1,375	12,247	1,238	11,567	1,169	16,330	1,651	10,206	917	9,526	749	
		20	0.05	11,907	1,203	10,716	1,084	10,121	1,023	14,288	1,445	8,931	721	8,335	588	
		25	0.05	11,907	1,203	10,716	1,084	10,121	1,023	14,288	1,445	8,931	721	8,335	588	
	0.8	30	0.03	11,312	1,144	10,181	1,029	9,615	972	13,574	1,373	8,483	685	7,918	559	
		6	0.22	20,790	2,336	18,711	2,102	17,672	1,985	24,948	2,803	15,593	1,401	14,553	1,144	
		8	0.2	18,900	2,123	17,010	1,911	16,065	1,805	22,680	2,547	14,175	1,274	13,230	1,040	
		12	0.13	15,309	1,548	13,778	1,393	13,013	1,316	18,371	1,857	11,482	1,031	10,716	842	
		16	0.1	13,608	1,375	12,247	1,238	11,567	1,169	16,330	1,651	10,206	917	9,526	749	
		20	0.06	11,907	1,203	10,716	1,084	10,121	1,023	14,288	1,445	8,931	721	8,335	588	
	2.5	0.1	25	0.057	11,907	1,203	10,716	1,084	10,121	1,023	14,288	1,445	8,931	721	8,335	588
			30	0.045	11,312	1,144	10,181	1,029	9,615	972	13,574	1,373	8,483	685	7,918	559
			10	0.05	15,309	1,548	13,778	1,393	13,013	1,316	18,371	2,064	11,482	1,031	10,716	842
		0.2	20	0.03	11,907	1,203	10,716	1,084	10,121	1,023	14,288	1,605	8,931	721	8,335	588
			30	0.025	11,312	1,144	10,181	1,029	9,615	972	13,574	1,373	8,483	685	7,918	559
			10	0.07	15,309	1,548	13,778	1,393	13,013	1,316	18,371	2,064	11,482	1,031	10,716	842
		0.3	20	0.04	11,907	1,203	10,716	1,084	10,121	1,023	14,288	1,605	8,931	721	8,335	588
			30	0.025	11,312	1,144	10,181	1,029	9,615	972	13,574	1,373	8,483	685	7,918	559
10			0.09	15,309	1,548	13,778	1,393	13,013	1,316	18,371	2,064	11,482	1,031	10,716	842	
0.5		20	0.06	11,907	1,203	10,716	1,084	10,121	1,023	14,288	1,605	8,931	721	8,335	588	
		30	0.03	11,312	1,144	10,181	1,029	9,615	972	13,574	1,373	8,483	685	7,918	559	
		10	0.12	15,309	1,548	13,778	1,393	13,013	1,316	18,371	2,064	11,482	1,031	10,716	842	
0.1	20	0.08	11,907	1,203	10,716	1,084	10,121	1,023	14,288	1,605	8,931	721	8,335	588		
	30	0.05	11,312	1,144	10,181	1,029	9,615	972	13,574	1,373	8,483	685	7,918	559		
	6	0.08	14,400	2,021	12,960	1,820	12,240	1,718	17,280	2,426	10,800	1,213	10,080	991		
3	0.1	8	0.07	14,400	2,021	12,960	1,820	12,240	1,718	17,280	2,426	10,800	1,213	10,080	991	

【Note】 Please refer to P.490

Recommended Cutting Datas to General Machining

SPM200-RN2

2 Flute, Extended Neck-Corner Radius End Mill

» continue

Workpiece Materials				P						N		H			
				Carbon Steel, Alloy Steel(180 ~ 250HB)		Alloy Steels, Tool Steels(25 ~ 35HRC)		PH, Ferrite, Martensite Steels(35 ~ 45HRC)		Copper, Copper Alloys		Hardened Steels (45 ~ 55HRC)		Hardened Steels (55 ~ 65HRC)	
Ratio to standard depth of cut(ap)				1.00		0.90		0.70		1.20		0.50		0.45	
Mill Dia. (mm)	r (mm)	Under Neck Length (mm)	ap	n r/min	Vf mm/min	n r/min	Vf mm/min	n r/min	Vf mm/min	n r/min	Vf mm/min	n r/min	Vf mm/min	n r/min	Vf mm/min
3	0.1	12	0.05	14,400	2,021	12,960	1,820	12,240	1,718	17,280	2,426	10,800	1,213	10,080	991
		16	0.035	14,400	2,021	12,960	1,820	12,240	1,718	17,280	2,426	10,800	1,213	10,080	991
		18	0.035	12,898	1,811	11,464	1,609	10,987	1,543	15,287	2,146	9,554	1,074	9,076	893
		20	0.035	11,664	1,638	10,498	1,474	9,914	1,392	13,997	1,966	8,748	983	8,165	803
		30	0.027	9,072	1,143	8,165	1,029	7,711	971	10,886	1,372	6,804	694	6,350	559
		35	0.02	9,072	1,143	8,165	1,029	7,711	971	10,886	1,372	6,804	694	6,350	559
	0.2	6	0.1	14,400	2,021	12,960	1,820	12,240	1,718	17,280	2,426	10,800	1,213	10,080	991
		8	0.09	14,400	2,021	12,960	1,820	12,240	1,718	17,280	2,426	10,800	1,213	10,080	991
		12	0.07	14,400	2,021	12,960	1,820	12,240	1,718	17,280	2,426	10,800	1,213	10,080	991
		16	0.05	14,400	2,021	12,960	1,820	12,240	1,718	17,280	2,426	10,800	1,213	10,080	991
		18	0.05	12,898	1,811	11,464	1,609	10,987	1,543	15,287	2,146	9,554	1,074	9,076	893
		20	0.05	11,664	1,638	10,498	1,474	9,914	1,392	13,997	1,966	8,748	983	8,165	803
	0.3	30	0.04	9,072	1,143	8,165	1,029	7,711	971	10,886	1,372	6,804	694	6,350	559
		35	0.035	9,072	1,143	8,165	1,029	7,711	971	10,886	1,372	6,804	694	6,350	559
		6	0.145	14,400	2,021	12,960	1,820	12,240	1,718	17,280	2,426	10,800	1,213	10,080	991
		8	0.13	14,400	2,021	12,960	1,820	12,240	1,718	17,280	2,426	10,800	1,213	10,080	991
		12	0.1	14,400	2,021	12,960	1,820	12,240	1,718	17,280	2,426	10,800	1,213	10,080	991
		16	0.075	14,400	2,021	12,960	1,820	12,240	1,718	17,280	2,426	10,800	1,213	10,080	991
	0.5	18	0.075	12,898	1,811	11,464	1,609	10,987	1,543	15,287	2,146	9,554	1,074	9,076	893
		20	0.075	11,664	1,638	10,498	1,474	9,914	1,392	13,997	1,966	8,748	983	8,165	803
		30	0.06	9,072	1,143	8,165	1,029	7,711	971	10,886	1,372	6,804	694	6,350	559
		35	0.05	9,072	1,143	8,165	1,029	7,711	971	10,886	1,372	6,804	694	6,350	559
		8	0.18	14,400	2,021	12,960	1,820	12,240	1,718	17,280	2,426	10,800	1,213	10,080	991
		12	0.13	14,400	2,021	12,960	1,820	12,240	1,718	17,280	2,426	10,800	1,213	10,080	991
	1	16	0.1	14,400	2,021	12,960	1,820	12,240	1,718	17,280	2,426	10,800	1,213	10,080	991
		18	0.1	12,898	1,811	11,464	1,609	12,240	1,718	15,287	2,146	9,554	1,074	9,076	893
		20	0.1	11,664	1,638	10,498	1,474	9,914	1,392	13,997	1,966	8,748	983	8,165	803
		30	0.08	9,072	1,143	8,165	1,029	7,711	971	10,886	1,372	6,804	694	6,350	559
35		0.065	9,072	1,143	8,165	1,029	7,711	971	10,886	1,372	6,804	694	6,350	559	
8		0.2	14,400	2,021	12,960	1,820	12,240	1,718	17,280	2,426	10,800	1,213	10,080	991	
1	12	0.15	14,400	2,021	12,960	1,820	12,240	1,718	17,280	2,426	10,800	1,213	10,080	991	
	16	0.12	14,400	2,021	12,960	1,820	12,240	1,718	17,280	2,426	10,800	1,213	10,080	991	

【Note】 Please refer to P.490

Recommended Cutting Datas to General Machining

SPM200-RN2

2 Flute, Extended Neck-Corner Radius End Mill

» continue

Workpiece Materials				P						N		H			
				Carbon Steel, Alloy Steel (180 ~ 250HB)		Alloy Steels, Tool Steels (25 ~ 35HRC)		PH, Ferrite, Martensite Steels (35 ~ 45HRC)		Copper, Copper Alloys		Hardened Steels (45 ~ 55HRC)		Hardened Steels (55 ~ 65HRC)	
Ratio to standard depth of cut (ap)				1.00		0.90		0.70		1.20		0.50		0.45	
Mill Dia. (mm)	r (mm)	Under Neck Length (mm)	ap	n r/min	Vf mm/min	n r/min	Vf mm/min	n r/min	Vf mm/min	n r/min	Vf mm/min	n r/min	Vf mm/min	n r/min	Vf mm/min
3	1	18	0.11	12,898	1,811	11,464	1,609	12,240	1,718	15,287	2,146	9,554	1,074	9,076	893
		20	0.11	11,664	1,638	10,498	1,474	9,914	1,392	13,997	1,966	8,748	983	8,165	803
		30	0.09	9,072	1,143	8,165	1,029	7,711	971	10,886	1,372	6,804	694	6,350	559
		35	0.075	9,072	1,143	8,165	1,029	7,711	971	10,886	1,372	6,804	694	6,350	559
4	0.1	8	0.08	12,420	2,160	11,178	1,944	10,557	1,836	14,904	2,592	9,315	1,296	8,694	1,058
		12	0.065	12,420	2,160	11,178	1,944	10,557	1,836	14,904	2,592	9,315	1,296	8,694	1,058
		16	0.06	10,301	1,791	9,064	1,576	8,652	1,504	12,360	2,149	7,416	1,031	7,004	852
		20	0.055	10,301	1,791	9,064	1,576	8,652	1,504	12,360	2,149	7,416	1,031	7,004	852
		30	0.045	8,239	1,290	7,415	1,161	7,003	1,096	9,887	1,547	6,179	774	5,767	632
		35	0.04	8,239	1,290	7,415	1,161	7,003	1,096	9,887	1,547	6,179	774	5,767	632
		45	0.03	6,592	825	5,933	743	5,603	702	7,910	990	4,945	499	4,614	401
	0.2	8	0.16	12,420	2,160	11,178	1,944	10,557	1,836	14,904	2,592	9,315	1,296	8,694	1,058
		12	0.14	12,420	2,160	11,178	1,944	10,557	1,836	14,904	2,592	9,315	1,296	8,694	1,058
		16	0.13	10,301	1,791	9,064	1,576	8,652	1,504	12,360	2,149	7,416	1,031	7,004	852
		20	0.11	10,301	1,791	9,064	1,576	8,652	1,504	12,360	2,149	7,416	1,031	7,004	852
		30	0.1	8,239	1,290	7,415	1,161	7,003	1,096	9,887	1,547	6,179	774	5,767	632
		35	0.08	8,239	1,290	7,415	1,161	7,003	1,096	9,887	1,547	6,179	774	5,767	632
		45	0.06	6,592	825	5,933	743	5,603	702	7,910	990	4,945	499	4,614	401
	0.3	8	0.24	12,420	2,160	11,178	1,944	10,557	1,836	14,904	2,592	9,315	1,296	8,694	1,058
		12	0.22	12,420	2,160	11,178	1,944	10,557	1,836	14,904	2,592	9,315	1,296	8,694	1,058
		16	0.2	10,301	1,791	9,064	1,576	8,652	1,504	12,360	2,149	7,416	1,031	7,004	852
		20	0.18	10,301	1,791	9,064	1,576	8,652	1,504	12,360	2,149	7,416	1,031	7,004	852
		30	0.16	8,239	1,290	7,415	1,161	7,003	1,096	9,887	1,547	6,179	774	5,767	632
		35	0.14	8,239	1,290	7,415	1,161	7,003	1,096	9,887	1,547	6,179	774	5,767	632
		45	0.12	6,592	825	5,933	743	5,603	702	7,910	990	4,945	499	4,614	401
	0.5	12	0.35	12,420	2,160	11,178	1,944	10,557	1,836	14,904	2,592	9,315	1,296	8,694	1,058
		16	0.25	10,301	1,791	9,064	1,576	8,652	1,504	12,360	2,149	7,416	1,031	7,004	852
		20	0.2	10,301	1,791	9,064	1,576	8,652	1,504	12,360	2,149	7,416	1,031	7,004	852
		30	0.15	8,239	1,290	7,415	1,161	7,003	1,096	9,887	1,547	6,179	774	5,767	632
		35	0.1	8,239	1,290	7,415	1,161	7,003	1,096	9,887	1,547	6,179	774	5,767	632
		45	0.05	6,592	825	5,933	743	5,603	702	7,910	990	4,945	499	4,614	401
		12	0.4	12,420	2,160	11,178	1,944	10,557	1,836	14,904	2,592	9,315	1,296	8,694	1,058

【Note】 Please refer to P.490

Recommended Cutting Datas to General Machining

SPM200-RN2

2 Flute, Extended Neck-Corner Radius End Mill

» continue

Workpiece Materials				P						N		H			
				Carbon Steel, Alloy Steel (180 ~ 250HB)		Alloy Steels, Tool Steels (25 ~ 35HRC)		PH, Ferrite, Martensite Steels (35 ~ 45HRC)		Copper, Copper Alloys		Hardened Steels (45 ~ 55HRC)		Hardened Steels (55 ~ 65HRC)	
Ratio to standard depth of cut (ap)				1.00		0.90		0.70		1.20		0.50		0.45	
Mill Dia. (mm)	r (mm)	Under Neck Length (mm)	ap	n r/min	Vf mm/min	n r/min	Vf mm/min	n r/min	Vf mm/min	n r/min	Vf mm/min	n r/min	Vf mm/min	n r/min	Vf mm/min
4	0.5	16	0.29	10,301	1,791	9,064	1,576	8,652	1,504	12,360	2,149	7,416	1,031	7,004	852
		20	0.23	10,301	1,791	9,064	1,576	8,652	1,504	12,360	2,149	7,416	1,031	7,004	852
		30	0.17	8,239	1,290	7,415	1,161	7,003	1,096	9,887	1,547	6,179	774	5,767	632
		35	0.12	8,239	1,290	7,415	1,161	7,003	1,096	9,887	1,547	6,179	774	5,767	632
		45	0.06	6,592	825	5,933	743	5,603	702	7,910	990	4,945	499	4,614	401
5	0.1	20	0.08	9,885	2,149	8,896	1,934	8,402	1,826	11,861	2,579	7,413	1,290	6,919	1,053
		40	0.06	8,901	1,733	8,011	1,561	7,566	1,473	10,681	2,081	6,676	1,040	6,231	850
	0.2	20	0.16	9,885	2,149	8,896	1,934	8,402	1,826	11,861	2,579	7,413	1,290	6,919	1,053
		40	0.13	8,901	1,733	8,011	1,561	7,566	1,473	10,681	2,081	6,676	1,040	6,231	850
	0.3	20	0.24	9,885	2,149	8,896	1,934	8,402	1,826	11,861	2,579	7,413	1,290	6,919	1,053
		40	0.2	8,901	1,733	8,011	1,561	7,566	1,473	10,681	2,081	6,676	1,040	6,231	850
	0.5	20	0.35	9,885	2,149	8,896	1,934	8,402	1,826	11,861	2,579	7,413	1,290	6,919	1,053
		40	0.135	8,901	1,733	8,011	1,561	7,566	1,473	10,681	2,081	6,676	1,040	6,231	850
	1	20	0.4	9,885	2,149	8,896	1,934	8,402	1,826	11,861	2,579	7,413	1,290	6,919	1,053
		40	0.15	8,901	1,733	8,011	1,561	7,566	1,473	10,681	2,081	6,676	1,040	6,231	850
6	0.1	12	0.08	8,239	2,149	7,415	1,934	7,003	1,827	9,887	2,579	6,179	1,290	5,767	1,053
		18	0.065	8,239	2,149	7,415	1,934	7,003	1,827	9,887	2,579	6,179	1,290	5,767	1,053
		24	0.06	8,239	2,149	7,415	1,934	7,003	1,827	9,887	2,579	6,179	1,290	5,767	1,053
		35	0.05	7,411	1,740	6,670	1,566	6,299	1,479	8,893	2,088	5,558	1,044	5,188	852
		55	0.04	5,765	1,354	5,189	1,219	4,901	1,150	6,918	1,625	4,325	812	4,036	663
	0.2	12	0.16	8,239	2,149	7,415	1,934	7,003	1,827	9,887	2,579	6,179	1,290	5,767	1,053
		18	0.14	8,239	2,149	7,415	1,934	7,003	1,827	9,887	2,579	6,179	1,290	5,767	1,053
		24	0.13	8,239	2,149	7,415	1,934	7,003	1,827	9,887	2,579	6,179	1,290	5,767	1,053
		35	0.11	7,411	1,740	6,670	1,566	6,299	1,479	8,893	2,088	5,558	1,044	5,188	852
		55	0.08	5,765	1,354	5,189	1,219	4,901	1,150	6,918	1,625	4,325	812	4,036	663
	0.3	12	0.24	8,239	2,149	7,415	1,934	7,003	1,827	9,887	2,579	6,179	1,290	5,767	1,053
		18	0.22	8,239	2,149	7,415	1,934	7,003	1,827	9,887	2,579	6,179	1,290	5,767	1,053
		24	0.2	8,239	2,149	7,415	1,934	7,003	1,827	9,887	2,579	6,179	1,290	5,767	1,053
		35	0.18	7,411	1,740	6,670	1,566	6,299	1,479	8,893	2,088	5,558	1,044	5,188	852
		55	0.14	5,765	1,354	5,189	1,219	4,901	1,150	6,918	1,625	4,325	812	4,036	663
	0.5	18	0.35	8,239	2,149	7,415	1,934	7,003	1,827	9,887	2,579	6,179	1,290	5,767	1,053
		24	0.29	8,239	2,149	7,415	1,934	7,003	1,827	9,887	2,579	6,179	1,290	5,767	1,053

[Note] Please refer to P.490

Recommended Cutting Datas to General Machining

SPM200-RN2

2 Flute, Extended Neck-Corner Radius End Mill

» continue

Workpiece Materials				P						N		H			
				Carbon Steel, Alloy Steel (180 ~ 250HB)		Alloy Steels, Tool Steels (25 ~ 35HRC)		PH, Ferrite, Martensite Steels (35 ~ 45HRC)		Copper, Copper Alloys		Hardened Steels (45 ~ 55HRC)		Hardened Steels (55 ~ 65HRC)	
Ratio to standard depth of cut (ap)				1.00		0.90		0.70		1.20		0.50		0.45	
Mill Dia. (mm)	r (mm)	Under Neck Length (mm)	ap	n r/min	Vf mm/min	n r/min	Vf mm/min	n r/min	Vf mm/min	n r/min	Vf mm/min	n r/min	Vf mm/min	n r/min	Vf mm/min
6	0.5	35	0.24	7,411	1,740	6,670	1,566	6,299	1,479	8,893	2,088	5,558	1,044	5,188	852
		55	0.165	5,765	1,354	5,189	1,219	4,901	1,150	6,918	1,625	4,325	812	4,036	663
	1	18	0.4	8,239	2,149	7,415	1,934	7,003	1,827	9,887	2,579	6,179	1,290	5,767	1,053
		24	0.35	8,239	2,149	7,415	1,934	7,003	1,827	9,887	2,579	6,179	1,290	5,767	1,053
		35	0.28	7,411	1,740	6,670	1,566	6,299	1,479	8,893	2,088	5,558	1,044	5,188	852
		55	0.2	5,765	1,354	5,189	1,219	4,901	1,150	6,918	1,625	4,325	812	4,036	663

【Note】

1. For different materials, adjust the cutting depth (ap) according to the cutting depth factors in the above table. E.g. for hardened steels (45 ~ 55HRC), ap*0.5.
2. Use the appropriate coolant such as air cooling or emulsion for the work material and machining shape.
3. In actual machining, the condition should be adjusted according to the machining shape, purpose and the machine type.
4. If the rpm of the machine is low, lower the feed rate also to put the rpm and feed rate in the same ratio.

Recommended Cutting Datas to High Accuracy Machining

SPM200-RN2

2 Flute, Extended Neck-Corner Radius End Mill

Workpiece Materials				P						N		H			
				Carbon Steel, Alloy Steel(180 ~ 250HB)		Alloy Steels, Tool Steels(25 ~ 35HRC)		PH, Ferrite, Martensite Steels(35 ~ 45HRC)		Copper, Copper Alloys		Hardened Steels (45 ~ 55HRC)		Hardened Steels (55 ~ 65HRC)	
Ratio to standard depth of cut(ap)				1.00		0.90		0.70		1.20		0.50		0.45	
Mill Dia. (mm)	r (mm)	Under Neck Length (mm)	ap	n r/min	Vf mm/min	n r/min	Vf mm/min	n r/min	Vf mm/min	n r/min	Vf mm/min	n r/min	Vf mm/min	n r/min	Vf mm/min
0.2	0.02	0.5	0.016	45,000	232	45,000	207	45,000	185	45,000	276	45,000	162	45,000	144
		1	0.011	45,000	232	45,000	207	45,000	185	45,000	276	45,000	162	45,000	144
		2	0.007	37,800	182	34,020	163	33,030	158	45,000	221	33,030	146	33,030	132
	0.05	0.5	0.02	45,000	232	45,000	207	45,000	185	45,000	276	45,000	162	45,000	144
		1	0.014	45,000	232	45,000	207	45,000	185	45,000	276	45,000	162	45,000	144
		1.5	0.008	45,000	216	43,740	201	41,310	182	45,000	248	41,310	153	41,310	138
0.3	0.02	1	0.016	45,000	527	45,000	464	45,000	410	45,000	626	45,000	302	45,000	288
		2	0.011	40,500	477	40,500	414	40,500	378	40,500	558	40,500	270	40,500	261
		3	0.007	31,500	371	31,500	322	31,500	293	36,000	454	27,000	180	27,000	175
	0.05	1	0.021	45,000	527	45,000	464	45,000	410	45,000	626	45,000	302	45,000	288
		1.5	0.016	45,000	527	40,500	464	40,500	410	45,000	626	40,500	302	40,500	288
		2	0.012	40,500	477	40,500	414	40,500	378	40,500	558	40,500	270	40,500	261
0.1	2.5	0.01	36,000	424	36,000	368	36,000	336	36,000	496	36,000	240	36,000	232	
	3	0.008	31,500	371	31,500	322	31,500	293	36,000	454	27,000	180	27,000	175	
0.4	0.02	1	0.016	45,000	522	45,000	466	45,000	415	45,000	622	36,000	288	32,400	243
		2	0.013	40,500	468	40,500	423	40,500	369	40,500	558	32,400	261	30,600	216
		3	0.01	36,000	369	36,000	333	36,000	297	36,000	432	29,520	216	23,040	180
		4	0.007	27,000	288	27,000	252	27,000	225	27,000	333	19,440	144	17,280	135
	0.05	1	0.025	45,000	522	45,000	466	45,000	415	45,000	622	36,000	288	32,400	243
		1.5	0.02	45,000	522	45,000	466	45,000	415	45,000	622	36,000	288	32,400	243
		2	0.016	40,500	468	40,500	423	40,500	369	40,500	558	32,400	261	30,600	216
		2.5	0.015	36,450	432	36,450	360	36,450	333	36,450	504	30,060	243	27,540	198
	0.1	3	0.014	36,000	369	36,000	333	36,000	297	36,000	432	29,520	216	23,040	180
		3.5	0.012	32,400	342	32,400	288	32,400	270	32,400	378	26,460	180	20,628	162
		4	0.008	27,000	288	27,000	252	27,000	225	27,000	333	19,440	144	17,280	135
		1	0.033	45,000	522	45,000	466	45,000	415	45,000	622	36,000	288	32,400	243
0.5	0.02	2	0.028	40,500	468	40,500	423	40,500	369	40,500	558	32,400	261	30,600	216
		3	0.016	36,000	369	36,000	333	36,000	297	36,000	432	29,520	216	23,040	180
0.5	0.02	4	0.01	27,000	288	27,000	252	27,000	225	27,000	333	19,440	144	17,280	135
		1	0.016	45,000	808	45,000	680	36,000	418	45,000	963	27,000	340	25,200	284
0.5	0.02	2	0.013	45,000	808	45,000	680	36,000	418	45,000	963	27,000	340	25,200	284

【Note】 Please refer to P.501

Recommended Cutting Datas to High Accuracy Machining

SPM200-RN2

2 Flute, Extended Neck-Corner Radius End Mill

» continue

Workpiece Materials				P						N		H				
				Carbon Steel, Alloy Steel (180 ~ 250HB)		Alloy Steels, Tool Steels (25 ~ 35HRC)		PH, Ferrite, Martensite Steels (35 ~ 45HRC)		Copper, Copper Alloys		Hardened Steels (45 ~ 55HRC)		Hardened Steels (55 ~ 65HRC)		
Ratio to standard depth of cut (ap)				1.00		0.90		0.70		1.20		0.50		0.45		
Mill Dia. (mm)	r (mm)	Under Neck Length (mm)	ap	n r/min	Vf mm/min	n r/min	Vf mm/min	n r/min	Vf mm/min	n r/min	Vf mm/min	n r/min	Vf mm/min	n r/min	Vf mm/min	
0.5	0.02	3	0.01	40,500	729	40,500	616	32,400	373	40,500	864	24,300	284	22,050	235	
		4	0.008	36,000	648	36,000	543	28,800	340	36,000	765	21,600	251	18,000	211	
		6	0.006	25,920	432	21,600	342	17,460	234	27,000	513	16,200	225	13,500	180	
	0.05	1	0.03	45,000	808	45,000	680	36,000	418	45,000	963	27,000	340	25,200	284	
		2	0.023	45,000	808	45,000	680	36,000	418	45,000	963	27,000	340	25,200	284	
		3	0.017	40,500	729	40,500	616	32,400	373	40,500	864	24,300	284	22,050	235	
		4	0.017	36,000	648	36,000	543	28,800	340	36,000	765	21,600	251	18,000	211	
		5	0.011	25,920	486	21,600	342	17,460	252	27,000	576	16,200	225	13,500	180	
		6	0.008	25,920	432	21,600	342	17,460	234	27,000	513	16,200	225	13,500	180	
	0.1	1	0.035	45,000	808	45,000	680	36,000	418	45,000	963	27,000	340	25,200	284	
		2	0.03	45,000	808	45,000	680	36,000	418	45,000	963	27,000	340	25,200	284	
		3	0.02	40,500	729	40,500	616	32,400	373	40,500	864	24,300	284	22,050	235	
		4	0.02	36,000	648	36,000	543	28,800	340	36,000	765	21,600	251	18,000	211	
		5	0.013	25,920	486	21,600	342	17,460	252	27,000	576	16,200	225	13,500	180	
		6	0.013	25,920	432	21,600	342	17,460	234	27,000	513	16,200	225	13,500	180	
	0.6	0.02	2	0.016	45,000	1,043	42,120	828	34,047	540	45,000	1,242	25,380	351	20,700	288
			4	0.013	36,000	747	31,050	558	25,020	396	36,000	882	21,240	252	18,900	207
			6	0.01	21,600	441	18,000	324	16,200	270	27,000	522	16,020	216	13,500	189
0.05		2	0.028	45,000	1,043	42,120	828	34,047	540	45,000	1,242	25,380	351	20,700	288	
		4	0.019	36,000	747	31,050	558	25,020	396	36,000	882	21,240	252	18,900	207	
		6	0.012	21,600	441	18,000	324	16,200	270	27,000	522	16,020	216	13,500	189	
		8	0.01	21,600	419	18,000	308	16,200	257	27,000	496	16,020	205	13,500	180	
		10	0.007	21,600	406	18,000	298	16,200	248	27,000	481	16,020	199	13,500	174	
0.1		2	0.035	45,000	1,043	42,120	828	34,047	540	45,000	1,242	25,380	351	20,700	288	
		4	0.024	36,000	747	31,050	558	25,020	396	36,000	882	21,240	252	18,900	207	
		6	0.015	21,600	441	18,000	324	16,200	270	27,000	522	16,020	216	13,500	189	
		8	0.013	21,600	419	18,000	308	16,200	257	27,000	496	16,020	205	13,500	180	
		10	0.009	21,600	406	18,000	298	16,200	248	27,000	481	16,020	199	13,500	174	
0.7		0.05	4	0.024	36,000	747	31,050	558	25,020	396	36,000	882	21,240	252	18,900	207
			6	0.015	21,600	441	18,000	324	16,200	270	27,000	522	16,020	216	13,500	189
	0.1	4	0.029	36,000	747	31,050	558	25,020	396	36,000	882	21,240	252	18,900	207	
		6	0.018	21,600	441	18,000	324	16,200	270	27,000	522	16,020	216	13,500	189	

【Note】 Please refer to P.501

Recommended Cutting Datas to High Accuracy Machining

SPM200-RN2

2 Flute, Extended Neck-Corner Radius End Mill

» continue

Workpiece Materials				P						N		H			
				Carbon Steel, Alloy Steel(180 ~ 250HB)		Alloy Steels, Tool Steels(25 ~ 35HRC)		PH, Ferrite, Martensite Steels(35 ~ 45HRC)		Copper, Copper Alloys		Hardened Steels (45 ~ 55HRC)		Hardened Steels (55 ~ 65HRC)	
Ratio to standard depth of cut(ap)				1.00		0.90		0.70		1.20		0.50		0.45	
Mill Dia. (mm)	r (mm)	Under Neck Length (mm)	ap	n r/min	Vf mm/min	n r/min	Vf mm/min	n r/min	Vf mm/min	n r/min	Vf mm/min	n r/min	Vf mm/min	n r/min	Vf mm/min
0.8	0.02	4	0.016	43,200	992	32,400	675	25,200	466	45,000	1,181	18,000	288	18,000	259
		6	0.013	34,830	720	23,400	477	22,500	415	36,000	855	16,200	259	16,200	230
	0.05	4	0.026	43,200	992	32,400	675	25,200	466	45,000	1,181	18,000	288	18,000	259
		6	0.015	34,830	720	23,400	477	22,500	415	36,000	855	16,200	259	16,200	230
		8	0.012	26,123	540	18,720	382	18,000	332	27,000	642	14,580	233	14,580	207
		12	0.01	26,123	513	18,720	363	18,000	315	27,000	609	14,580	221	14,580	197
	0.1	4	0.032	43,200	992	32,400	675	25,200	466	45,000	1,181	18,000	288	18,000	259
		6	0.019	34,830	720	23,400	477	22,500	415	36,000	855	16,200	259	16,200	230
		8	0.015	26,123	540	18,720	382	18,000	332	27,000	642	14,580	233	14,580	207
		12	0.012	26,123	513	18,720	363	18,000	315	27,000	609	14,580	221	14,580	197
	0.2	4	0.056	43,200	992	32,400	675	25,200	466	45,000	1,181	18,000	288	18,000	259
		6	0.032	34,830	720	23,400	477	22,500	415	36,000	855	16,200	259	16,200	230
8		0.018	26,123	540	18,720	382	18,000	332	27,000	642	14,580	233	14,580	207	
12		0.015	26,123	513	18,720	363	18,000	315	27,000	609	14,580	221	14,580	197	
1	0.02	2	0.016	32,101	1,412	28,868	1,270	27,265	1,091	38,408	1,689	24,057	866	22,453	718
		4	0.013	29,160	1,223	26,244	1,101	24,786	935	34,992	1,467	21,870	734	20,412	599
		6	0.01	23,620	891	21,258	802	20,076	758	28,344	1,070	17,715	594	16,534	485
		8	0.008	20,995	792	18,896	713	17,846	673	25,195	950	15,746	528	14,697	431
		10	0.006	18,371	693	16,534	624	15,615	590	19,596	832	13,778	463	12,859	377
		12	0.005	16,330	548	14,697	493	13,880	408	19,596	657	12,247	359	11,431	288
	0.05	2	0.046	32,101	1,412	28,868	1,270	27,229	1,089	38,408	1,689	24,057	866	22,453	718
		3	0.035	30,618	1,316	27,556	1,185	27,265	1,091	36,716	1,579	22,964	780	21,433	643
		4	0.027	29,160	1,223	26,244	1,101	26,025	1,015	34,992	1,467	21,870	734	20,412	599
		5	0.021	25,981	1,039	23,384	935	24,786	935	31,242	1,249	19,486	654	18,187	535
		6	0.017	23,620	891	21,258	802	22,084	835	28,344	1,070	17,715	594	16,534	485
		8	0.016	20,995	792	18,896	713	17,846	673	25,195	950	15,746	528	14,697	431
		10	0.011	18,371	693	16,534	624	15,615	590	22,045	832	13,778	463	12,859	377
		12	0.01	16,330	548	14,697	493	13,880	408	19,596	657	12,247	359	11,431	288
		16	0.006	16,330	480	14,697	431	13,880	378	19,596	575	12,247	308	11,431	239
		20	0.004	12,247	359	11,022	323	10,410	284	14,697	431	9,185	231	8,573	180
	0.1	2	0.065	32,101	1,412	28,868	1,270	27,265	1,091	38,408	1,689	24,057	866	22,453	718
		3	0.05	30,618	1,316	27,556	1,185	26,025	1,015	36,716	1,579	22,964	780	21,433	643

【Note】 Please refer to P.501

Recommended Cutting Datas to High Accuracy Machining

SPM200-RN2

2 Flute, Extended Neck-Corner Radius End Mill

» continue

Workpiece Materials				P						N		H			
				Carbon Steel, Alloy Steel (180 ~ 250HB)		Alloy Steels, Tool Steels (25 ~ 35HRC)		PH, Ferrite, Martensite Steels (35 ~ 45HRC)		Copper, Copper Alloys		Hardened Steels (45 ~ 55HRC)		Hardened Steels (55 ~ 65HRC)	
Ratio to standard depth of cut (ap)				1.00		0.90		0.70		1.20		0.50		0.45	
Mill Dia. (mm)	r (mm)	Under Neck Length (mm)	ap	n r/min	Vf mm/min	n r/min	Vf mm/min	n r/min	Vf mm/min	n r/min	Vf mm/min	n r/min	Vf mm/min	n r/min	Vf mm/min
1	0.1	4	0.038	29,160	1,223	26,244	1,101	24,786	935	34,992	1,467	21,870	734	20,412	599
		5	0.03	25,981	1,039	23,384	935	22,084	835	31,242	1,249	19,486	654	18,187	535
		6	0.024	23,620	891	21,258	802	20,076	758	28,344	1,070	17,715	594	16,534	485
		8	0.024	20,995	792	18,896	713	17,846	673	25,195	950	15,746	528	14,697	431
		10	0.015	18,371	693	16,534	624	15,615	590	22,045	832	13,778	463	12,859	377
		12	0.015	16,330	548	14,697	493	13,880	408	19,596	657	12,247	359	11,431	288
		16	0.009	16,330	480	14,697	431	13,880	378	19,596	575	12,247	308	11,431	239
		20	0.006	12,247	359	11,022	323	10,410	284	14,697	431	9,185	231	8,573	180
	0.2	2	0.11	32,101	1,412	28,868	1,270	27,265	1,091	38,408	1,689	24,057	866	22,453	718
		3	0.09	30,618	1,316	27,556	1,185	26,025	1,015	36,716	1,579	22,964	780	21,433	643
		4	0.07	29,160	1,223	26,244	1,101	24,786	935	34,992	1,467	21,870	734	20,412	599
		5	0.05	25,981	1,039	23,384	935	22,084	835	31,242	1,249	19,486	654	18,187	535
		6	0.04	23,620	891	21,258	802	20,076	758	28,344	1,070	17,715	594	16,534	485
		8	0.04	20,995	792	18,896	713	17,846	673	25,195	950	15,746	528	14,697	431
		10	0.025	18,371	693	16,534	624	15,615	590	22,045	832	13,778	463	12,859	377
		12	0.025	16,330	548	14,697	493	13,880	408	19,596	657	12,247	359	11,431	288
	0.3	16	0.015	16,330	480	14,697	431	13,880	378	19,596	575	12,247	308	11,431	239
		20	0.01	12,247	359	11,022	323	10,410	284	14,697	431	9,185	231	8,573	180
		2	0.11	32,101	1,412	28,868	1,270	27,265	1,091	38,408	1,689	24,057	866	22,453	718
		3	0.09	30,618	1,316	27,556	1,185	26,025	1,015	36,716	1,579	22,964	780	21,433	643
		4	0.07	29,160	1,223	26,244	1,101	24,786	935	34,992	1,467	21,870	734	20,412	599
		5	0.05	25,981	1,039	23,384	935	22,084	835	31,242	1,249	19,486	654	18,187	535
		6	0.04	23,620	891	21,258	802	20,076	758	28,344	1,070	17,715	594	16,534	485
		8	0.04	20,995	792	18,896	713	17,846	673	25,195	950	15,746	528	14,697	431
1.25	0.1	10	0.015	18,371	693	16,534	624	15,615	590	22,045	832	13,778	463	12,859	377
		15	0.01	16,330	480	14,697	493	13,880	408	19,596	575	12,247	308	11,431	239
		20	0.006	12,247	359	11,022	323	10,410	284	14,697	431	9,185	231	8,573	180
		5	0.03	25,981	1,039	23,384	935	22,084	835	31,242	1,249	19,486	654	18,187	535

【Note】 Please refer to P.501

Recommended Cutting Datas to High Accuracy Machining

SPM200-RN2

2 Flute, Extended Neck-Corner Radius End Mill

» continue

Workpiece Materials				P						N		H			
				Carbon Steel, Alloy Steel (180 ~ 250HB)		Alloy Steels, Tool Steels (25 ~ 35HRC)		PH, Ferrite, Martensite Steels (35 ~ 45HRC)		Copper, Copper Alloys		Hardened Steels (45 ~ 55HRC)		Hardened Steels (55 ~ 65HRC)	
Ratio to standard depth of cut (ap)				1.00		0.90		0.70		1.20		0.50		0.45	
Mill Dia. (mm)	r (mm)	Under Neck Length (mm)	ap	n r/min	Vf mm/min	n r/min	Vf mm/min	n r/min	Vf mm/min	n r/min	Vf mm/min	n r/min	Vf mm/min	n r/min	Vf mm/min
1.25	0.2	5	0.05	25,981	1,039	23,384	935	22,084	835	31,242	1,249	19,486	654	18,187	535
		10	0.025	18,371	693	16,534	624	15,615	590	22,045	832	13,778	463	12,859	377
		15	0.016	16,330	480	14,697	493	13,880	408	19,596	575	12,247	308	11,431	239
		20	0.01	12,247	359	11,022	323	10,410	284	14,697	431	9,185	231	8,573	180
	0.3	5	0.05	25,981	1,039	23,384	935	22,084	835	31,242	1,249	19,486	654	18,187	535
		10	0.025	18,371	693	16,534	624	15,615	590	22,045	832	13,778	463	12,859	377
		15	0.016	16,330	480	14,697	493	13,880	408	19,596	575	12,247	308	11,431	239
		20	0.01	12,247	359	11,022	323	10,410	284	14,697	431	9,185	231	8,573	180
1.5	0.1	4	0.042	22,437	1,017	20,208	915	18,860	852	26,944	1,220	16,840	677	15,628	550
		6	0.04	21,401	967	19,299	872	18,344	829	25,605	1,157	16,051	644	14,904	524
		8	0.036	20,412	924	18,371	832	17,350	786	24,494	1,110	15,309	617	14,288	503
		12	0.036	16,330	740	14,697	666	13,880	628	19,596	887	12,247	493	11,431	402
		15	0.023	12,701	511	11,431	460	10,796	381	15,241	614	9,526	336	8,890	268
		20	0.018	12,701	511	11,431	460	10,796	381	15,241	614	9,526	336	8,890	268
	0.2	4	0.07	22,437	1,017	20,208	915	18,860	781	26,944	1,220	16,840	610	15,628	500
		6	0.065	21,401	967	19,299	872	18,344	829	25,605	1,157	16,051	644	14,904	524
		8	0.06	20,412	924	18,371	832	17,350	786	24,494	1,110	15,309	617	14,288	503
		12	0.06	16,330	740	14,697	666	13,880	628	19,596	887	12,247	493	11,431	402
		15	0.038	12,701	511	11,431	460	10,796	381	15,241	614	9,526	336	8,890	268
		20	0.03	12,701	511	11,431	460	10,796	381	15,241	614	9,526	336	8,890	268
	0.3	4	0.07	22,437	1,017	20,208	915	18,860	781	26,944	1,220	16,840	610	15,628	500
		6	0.065	21,401	967	19,299	872	18,344	829	25,605	1,157	16,051	644	14,904	524
		8	0.06	20,412	924	18,371	832	17,350	786	24,494	1,110	15,309	617	14,288	503
		12	0.06	16,330	740	14,697	666	13,880	628	19,596	887	12,247	493	11,431	402
		15	0.038	12,701	511	11,431	460	10,796	381	15,241	614	9,526	336	8,890	268
		20	0.03	12,701	511	11,431	460	10,796	381	15,241	614	9,526	336	8,890	268
	0.5	4	0.085	22,437	1,017	20,208	915	18,860	781	26,944	1,220	16,840	610	15,628	500
		6	0.08	21,401	967	19,299	872	18,344	829	25,605	1,157	16,051	644	14,904	524
		8	0.07	20,412	924	18,371	832	17,350	786	24,494	1,110	15,309	617	14,288	503
		12	0.065	16,330	740	14,697	666	13,880	628	19,596	887	12,247	493	11,431	402
		15	0.045	12,701	511	11,431	460	10,796	381	15,241	614	9,526	336	8,890	268
		20	0.035	12,701	511	11,431	460	10,796	381	15,241	614	9,526	336	8,890	268

【Note】 Please refer to P.501

Recommended Cutting Datas to High Accuracy Machining

SPM200-RN2

2 Flute, Extended Neck-Corner Radius End Mill

» continue

Workpiece Materials				P						N		H			
				Carbon Steel, Alloy Steel (180 ~ 250HB)		Alloy Steels, Tool Steels (25 ~ 35HRC)		PH, Ferrite, Martensite Steels (35 ~ 45HRC)		Copper, Copper Alloys		Hardened Steels (45 ~ 55HRC)		Hardened Steels (55 ~ 65HRC)	
Ratio to standard depth of cut (ap)				1.00		0.90		0.70		1.20		0.50		0.45	
Mill Dia. (mm)	r (mm)	Under Neck Length (mm)	ap	n r/min	Vf mm/min	n r/min	Vf mm/min	n r/min	Vf mm/min	n r/min	Vf mm/min	n r/min	Vf mm/min	n r/min	Vf mm/min
1.75	0.1	5	0.04	22,437	1,017	20,208	915	18,860	781	26,944	1,220	16,840	610	15,628	500
		10	0.036	20,412	924	18,371	832	17,350	786	24,494	1,110	15,309	617	14,288	503
		15	0.023	12,701	511	11,431	460	10,796	381	15,241	614	9,526	336	8,890	268
		20	0.018	12,701	511	11,431	460	10,796	381	15,241	614	9,526	336	8,890	268
	0.2	5	0.065	22,437	1,017	20,208	915	18,860	781	26,944	1,220	16,840	610	15,628	500
		10	0.06	20,412	924	18,371	832	17,350	786	24,494	1,110	15,309	617	14,288	503
		15	0.038	12,701	511	11,431	460	10,796	381	15,241	614	9,526	336	8,890	268
		20	0.03	12,701	511	11,431	460	10,796	381	15,241	614	9,526	336	8,890	268
	0.3	5	0.065	22,437	1,017	20,208	915	18,860	781	26,944	1,220	16,840	610	15,628	500
		10	0.06	20,412	924	18,371	832	17,350	786	24,494	1,110	15,309	617	14,288	503
		15	0.038	12,701	511	11,431	460	10,796	381	15,241	614	9,526	336	8,890	268
		20	0.03	12,701	511	11,431	460	10,796	381	15,241	614	9,526	336	8,890	268
2	0.1	4	0.08	19,777	1,554	17,771	1,396	16,624	1,306	23,503	1,847	14,761	930	13,757	756
		6	0.07	18,711	1,472	16,840	1,324	15,905	1,250	22,453	1,766	14,034	883	13,098	721
		8	0.055	17,010	1,337	15,309	1,203	14,459	1,137	20,412	1,605	12,758	803	11,907	655
		12	0.03	13,778	975	12,400	878	11,712	829	16,534	1,170	10,334	650	9,644	531
		16	0.03	12,247	867	11,022	780	10,410	736	14,697	1,040	9,185	578	8,573	472
		20	0.025	10,716	759	9,644	682	9,109	644	12,859	910	8,037	506	7,502	413
		25	0.015	10,716	681	9,644	613	9,109	579	12,859	817	8,037	455	7,502	370
	0.2	4	0.1	19,777	1,554	17,771	1,396	16,624	1,306	23,503	1,847	14,761	930	13,757	756
		6	0.08	18,711	1,472	16,840	1,324	15,905	1,250	22,453	1,766	14,034	883	13,098	721
		8	0.07	17,010	1,337	15,309	1,203	14,459	1,137	20,412	1,605	12,758	803	11,907	655
		12	0.04	13,778	975	12,400	878	11,712	829	16,534	1,170	10,334	650	9,644	531
		16	0.04	12,247	867	11,022	780	10,410	736	14,697	1,040	9,185	578	8,573	472
		20	0.035	10,716	759	9,644	682	9,109	644	12,859	910	8,037	506	7,502	413
		25	0.025	10,716	681	9,644	613	9,109	579	12,859	817	8,037	455	7,502	370
	0.3	4	0.13	19,777	1,554	17,771	1,396	16,624	1,306	23,503	1,847	14,761	930	13,757	756
		6	0.11	18,711	1,472	16,840	1,324	15,905	1,250	22,453	1,766	14,034	883	13,098	721
		8	0.09	17,010	1,337	15,309	1,203	14,459	1,137	20,412	1,605	12,758	803	11,907	655
		12	0.06	13,778	975	12,400	878	11,712	829	16,534	1,300	10,334	650	9,644	531

【Note】 Please refer to P.501

Recommended Cutting Datas to High Accuracy Machining

SPM200-RN2

2 Flute, Extended Neck-Corner Radius End Mill

» continue

Workpiece Materials				P						N		H				
				Carbon Steel, Alloy Steel (180 ~ 250HB)		Alloy Steels, Tool Steels (25 ~ 35HRC)		PH, Ferrite, Martensite Steels (35 ~ 45HRC)		Copper, Copper Alloys		Hardened Steels (45 ~ 55HRC)		Hardened Steels (55 ~ 65HRC)		
Ratio to standard depth of cut (ap)				1.00		0.90		0.70		1.20		0.50		0.45		
Mill Dia. (mm)	r (mm)	Under Neck Length (mm)	ap	n r/min	Vf mm/min	n r/min	Vf mm/min	n r/min	Vf mm/min	n r/min	Vf mm/min	n r/min	Vf mm/min	n r/min	Vf mm/min	
2	0.3	16	0.06	12,247	867	11,022	780	10,410	736	14,697	1,156	9,185	578	8,573	472	
		20	0.037	10,716	759	9,644	682	9,109	644	12,859	1,011	8,037	506	7,502	413	
		25	0.03	10,716	681	9,644	613	9,109	579	12,859	817	8,037	455	7,502	370	
		30	0.021	10,181	647	9,162	582	8,654	550	12,217	777	7,636	432	7,126	352	
	0.5	6	0.17	18,711	1,472	16,840	1,324	15,905	1,250	22,453	1,766	14,034	883	13,098	721	
		8	0.14	17,010	1,337	15,309	1,203	14,459	1,137	20,412	1,605	12,758	803	11,907	655	
		12	0.08	13,778	975	12,400	878	11,712	921	16,534	1,300	10,334	650	9,644	531	
		16	0.08	12,247	867	11,022	780	10,410	736	14,697	1,156	9,185	578	8,573	472	
		20	0.05	10,716	759	9,644	682	9,109	644	12,859	1,011	8,037	506	7,502	413	
		25	0.05	10,716	681	9,644	613	9,109	579	12,859	817	8,037	455	7,502	370	
	0.8	6	0.22	18,711	1,472	16,840	1,324	15,905	1,250	22,453	1,766	14,034	883	13,098	721	
		8	0.2	17,010	1,337	15,309	1,203	14,459	1,137	20,412	1,605	12,758	803	11,907	655	
		12	0.13	13,778	975	12,400	878	11,712	829	16,534	1,300	10,334	650	9,644	531	
		16	0.1	12,247	867	11,022	780	10,410	736	14,697	1,156	9,185	578	8,573	472	
		20	0.06	10,716	759	9,644	682	9,109	644	12,859	1,011	8,037	506	7,502	413	
		25	0.057	10,716	681	9,644	613	9,109	579	12,859	817	8,037	455	7,502	370	
	2.5	0.1	10	0.055	17,010	1,337	15,309	1,203	14,459	1,137	20,412	1,605	12,758	803	11,907	655
			20	0.03	12,247	867	11,022	780	10,410	736	14,697	1,156	9,185	578	8,573	472
			30	0.015	10,716	681	9,644	613	9,109	579	12,859	907	8,037	455	7,502	370
		0.2	10	0.07	17,010	1,337	15,309	1,203	14,459	1,137	20,412	1,605	12,758	803	11,907	655
			20	0.04	12,247	867	11,022	780	10,410	736	14,697	1,156	9,185	578	8,573	472
			30	0.025	10,716	681	9,644	613	9,109	579	12,859	907	8,037	455	7,502	370
		0.3	10	0.09	17,010	1,337	15,309	1,203	14,459	1,137	20,412	1,605	12,758	803	11,907	655
			20	0.06	12,247	867	11,022	780	10,410	736	14,697	1,156	9,185	578	8,573	472
30			0.03	10,716	681	9,644	613	9,109	579	12,859	907	8,037	455	7,502	370	
0.5		10	0.14	17,010	1,337	15,309	1,203	14,459	1,137	20,412	1,605	12,758	803	11,907	655	
		20	0.08	12,247	867	11,022	780	10,410	736	14,697	1,156	9,185	578	8,573	472	
		30	0.05	10,716	681	9,644	613	9,109	579	12,859	907	8,037	455	7,502	370	
3	0.1	6	0.08	12,960	1,274	11,664	1,147	11,016	1,083	15,552	1,528	9,720	764	9,072	624	
		8	0.07	12,960	1,274	11,664	1,147	11,016	1,083	15,552	1,528	9,720	764	9,072	624	

【Note】 Please refer to P.501

Recommended Cutting Datas to High Accuracy Machining

SPM200-RN2

2 Flute, Extended Neck-Corner Radius End Mill

» continue

Workpiece Materials				P						N		H				
				Carbon Steel, Alloy Steel (180 ~ 250HB)		Alloy Steels, Tool Steels (25 ~ 35HRC)		PH, Ferrite, Martensite Steels (35 ~ 45HRC)		Copper, Copper Alloys		Hardened Steels (45 ~ 55HRC)		Hardened Steels (55 ~ 65HRC)		
Ratio to standard depth of cut (ap)				1.00		0.90		0.70		1.20		0.50		0.45		
Mill Dia. (mm)	r (mm)	Under Neck Length (mm)	ap	n r/min	Vf mm/min	n r/min	Vf mm/min	n r/min	Vf mm/min	n r/min	Vf mm/min	n r/min	Vf mm/min	n r/min	Vf mm/min	
3	0.1	12	0.05	12,960	1,274	11,664	1,147	11,016	1,083	15,552	1,528	9,720	764	9,072	624	
		16	0.035	12,960	1,274	11,664	1,147	11,016	1,083	15,552	1,528	9,720	764	9,072	624	
		18	0.035	11,656	1,144	10,509	1,034	9,841	966	13,948	1,369	8,789	690	8,121	558	
		20	0.035	10,498	1,031	9,448	929	8,923	877	12,597	1,238	7,873	618	7,349	505	
		30	0.027	8,165	721	7,349	649	6,940	613	9,797	866	6,124	432	5,715	354	
		35	0.02	8,165	721	7,349	649	6,940	613	9,797	866	6,124	432	5,715	354	
	0.2	6	0.1	12,960	1,274	11,664	1,147	11,016	1,083	15,552	1,528	9,720	764	9,072	624	
		8	0.09	12,960	1,274	11,664	1,147	11,016	1,083	15,552	1,528	9,720	764	9,072	624	
		12	0.07	12,960	1,274	11,664	1,147	11,016	1,083	15,552	1,528	9,720	764	9,072	624	
		16	0.05	12,960	1,274	11,664	1,147	11,016	1,083	15,552	1,528	9,720	764	9,072	624	
		18	0.05	11,656	1,144	10,509	1,034	9,841	966	13,948	1,369	8,789	690	8,121	558	
		20	0.05	10,498	1,031	9,448	929	8,923	877	12,597	1,238	7,873	618	7,349	505	
	0.3	6	0.145	12,960	1,274	11,664	1,147	11,016	1,083	15,552	1,528	9,720	764	9,072	624	
		8	0.13	12,960	1,274	11,664	1,147	11,016	1,083	15,552	1,528	9,720	764	9,072	624	
		12	0.1	12,960	1,274	11,664	1,147	11,016	1,083	15,552	1,528	9,720	764	9,072	624	
		16	0.075	12,960	1,274	11,664	1,147	11,016	1,083	15,552	1,528	9,720	764	9,072	624	
		18	0.075	11,656	1,144	10,509	1,034	9,841	966	13,948	1,369	8,789	690	8,121	558	
		20	0.075	10,498	1,031	9,448	929	8,923	877	12,597	1,238	7,873	618	7,349	505	
	0.5	30	0.06	8,165	721	7,349	649	6,940	613	9,797	866	6,124	432	5,715	354	
		35	0.05	8,165	721	7,349	649	6,940	613	9,797	866	6,124	432	5,715	354	
		1	8	0.18	12,960	1,274	11,664	1,147	11,016	1,083	15,552	1,528	9,720	764	9,072	624
			12	0.13	12,960	1,274	11,664	1,147	11,016	1,083	15,552	1,528	9,720	764	9,072	624
			16	0.1	12,960	1,274	11,664	1,147	11,016	1,083	15,552	1,528	9,720	764	9,072	624
			18	0.1	11,656	1,144	10,509	1,034	9,841	966	13,948	1,369	8,789	690	8,121	558
20	0.1		10,498	1,031	9,448	929	8,923	877	12,597	1,238	7,873	618	7,349	505		
30	0.08		8,165	721	7,349	649	6,940	613	9,797	866	6,124	432	5,715	354		
1	35	0.065	8,165	721	7,349	649	6,940	613	9,797	866	6,124	432	5,715	354		
	8	0.2	12,960	1,274	11,664	1,147	11,016	1,083	15,552	1,528	9,720	764	9,072	624		
	12	0.15	12,960	1,274	11,664	1,147	11,016	1,083	15,552	1,528	9,720	764	9,072	624		
		16	0.12	12,960	1,274	11,664	1,147	11,016	1,083	15,552	1,528	9,720	764	9,072	624	

【Note】 Please refer to P.501

Recommended Cutting Datas to High Accuracy Machining

SPM200-RN2

2 Flute, Extended Neck-Corner Radius End Mill

» continue

Workpiece Materials				P						N		H			
				Carbon Steel, Alloy Steel (180 ~ 250HB)		Alloy Steels, Tool Steels (25 ~ 35HRC)		PH, Ferrite, Martensite Steels (35 ~ 45HRC)		Copper, Copper Alloys		Hardened Steels (45 ~ 55HRC)		Hardened Steels (55 ~ 65HRC)	
Ratio to standard depth of cut (ap)				1.00		0.90		0.70		1.20		0.50		0.45	
Mill Dia. (mm)	r (mm)	Under Neck Length (mm)	ap	n r/min	Vf mm/min	n r/min	Vf mm/min	n r/min	Vf mm/min	n r/min	Vf mm/min	n r/min	Vf mm/min	n r/min	Vf mm/min
3	1	18	0.11	11,656	1,144	10,509	1,034	9,841	966	13,948	1,369	8,789	690	8,121	558
		20	0.11	10,498	1,031	9,448	929	8,923	877	12,597	1,238	7,873	618	7,349	505
		30	0.09	8,165	721	7,349	649	6,940	613	9,797	866	6,124	432	5,715	354
		35	0.075	8,165	721	7,349	649	6,940	613	9,797	866	6,124	432	5,715	354
4	0.1	8	0.08	10,092	1,755	9,082	1,580	8,578	1,492	12,110	2,106	7,569	1,053	7,064	860
		12	0.065	10,092	1,755	9,082	1,580	8,578	1,492	12,110	2,106	7,569	1,053	7,064	860
		16	0.06	9,230	1,605	8,240	1,433	7,827	1,361	11,124	1,934	6,839	951	6,016	733
		20	0.055	9,230	1,605	8,240	1,433	7,827	1,361	11,124	1,934	6,839	951	6,016	733
		30	0.045	9,230	1,605	8,240	1,433	6,180	968	11,124	1,934	4,942	619	4,612	505
		35	0.04	9,230	1,605	8,240	1,433	6,180	968	11,124	1,934	4,942	619	4,612	505
		45	0.03	7,416	968	6,592	860	5,026	655	8,899	1,160	4,450	464	3,707	322
		45	0.03	7,416	968	6,592	860	5,026	655	8,899	1,160	4,450	464	3,707	322
	0.2	8	0.16	10,092	1,755	9,082	1,580	8,578	1,492	12,110	2,106	7,569	1,053	7,064	860
		12	0.14	10,092	1,755	9,082	1,580	8,578	1,492	12,110	2,106	7,569	1,053	7,064	860
		16	0.13	9,230	1,605	8,240	1,433	7,827	1,361	11,124	1,934	6,839	951	6,016	733
		20	0.11	9,230	1,605	8,240	1,433	7,827	1,361	11,124	1,934	6,839	951	6,016	733
		30	0.1	9,230	1,605	8,240	1,433	6,180	968	11,124	1,934	4,942	619	4,612	505
		35	0.08	9,230	1,605	8,240	1,433	6,180	968	11,124	1,934	4,942	619	4,612	505
		45	0.06	7,416	968	6,592	860	5,026	655	8,899	1,160	4,450	464	3,707	322
		45	0.06	7,416	968	6,592	860	5,026	655	8,899	1,160	4,450	464	3,707	322
	0.3	8	0.24	10,092	1,755	9,082	1,580	8,578	1,492	12,110	2,106	7,569	1,053	7,064	860
		12	0.22	10,092	1,755	9,082	1,580	8,578	1,492	12,110	2,106	7,569	1,053	7,064	860
		16	0.2	9,230	1,605	8,240	1,433	7,827	1,361	11,124	1,934	6,839	951	6,016	733
		20	0.18	9,230	1,605	8,240	1,433	7,827	1,361	11,124	1,934	6,839	951	6,016	733
		30	0.16	9,230	1,605	8,240	1,433	6,180	968	11,124	1,934	4,942	619	4,612	505
		35	0.14	9,230	1,605	8,240	1,433	6,180	968	11,124	1,934	4,942	619	4,612	505
		45	0.12	7,416	968	6,592	860	5,026	655	8,899	1,160	4,450	464	3,707	322
		45	0.12	7,416	968	6,592	860	5,026	655	8,899	1,160	4,450	464	3,707	322
	0.5	12	0.35	10,092	1,755	9,082	1,580	8,578	1,492	12,110	2,106	7,569	1,053	7,064	860
		16	0.25	9,230	1,605	8,240	1,433	7,827	1,361	11,124	1,934	6,839	951	6,016	733
		20	0.2	9,230	1,605	8,240	1,433	7,827	1,361	11,124	1,934	6,839	951	6,016	733
		30	0.15	9,230	1,605	8,240	1,433	6,180	968	11,124	1,934	4,942	619	4,612	505
35		0.1	9,230	1,605	8,240	1,433	6,180	968	11,124	1,934	4,942	619	4,612	505	
45		0.05	7,416	968	6,592	860	5,026	655	8,899	1,160	4,450	464	3,707	322	
1	12	0.4	10,092	1,755	9,082	1,580	8,578	1,492	12,110	2,106	7,569	1,053	7,064	860	

[Note] Please refer to P.501

Recommended Cutting Datas to High Accuracy Machining

SPM200-RN2

2 Flute, Extended Neck-Corner Radius End Mill

» continue

Workpiece Materials				P						N		H				
				Carbon Steel, Alloy Steel (180 ~ 250HB)		Alloy Steels, Tool Steels (25 ~ 35HRC)		PH, Ferrite, Martensite Steels (35 ~ 45HRC)		Copper, Copper Alloys		Hardened Steels (45 ~ 55HRC)		Hardened Steels (55 ~ 65HRC)		
Ratio to standard depth of cut (ap)				1.00		0.90		0.70		1.20		0.50		0.45		
Mill Dia. (mm)	r (mm)	Under Neck Length (mm)	ap	n r/min	Vf mm/min	n r/min	Vf mm/min	n r/min	Vf mm/min	n r/min	Vf mm/min	n r/min	Vf mm/min	n r/min	Vf mm/min	
4	1	16	0.29	9,230	1,605	8,240	1,433	7,827	1,361	11,124	1,934	6,839	951	6,016	733	
		20	0.23	9,230	1,605	8,240	1,433	7,827	1,361	11,124	1,934	6,839	951	6,016	733	
		30	0.17	9,230	1,605	8,240	1,433	6,180	968	11,124	1,934	4,942	619	4,612	505	
		35	0.12	9,230	1,605	8,240	1,433	6,180	968	11,124	1,934	4,942	619	4,612	505	
		45	0.06	7,416	968	6,592	860	5,026	655	8,899	1,160	4,450	464	3,707	322	
5	0.1	20	0.08	8,239	1,791	7,415	1,612	7,003	1,523	9,887	2,149	6,179	1,075	5,767	878	
		40	0.06	5,931	1,156	5,338	1,040	5,042	982	7,116	1,386	4,449	693	4,152	566	
	0.2	20	0.16	8,239	1,791	7,415	1,612	7,003	1,523	9,887	2,149	6,179	1,075	5,767	878	
		40	0.13	5,931	1,156	5,338	1,040	5,042	982	7,116	1,386	4,449	693	4,152	566	
	0.3	20	0.24	8,239	1,791	7,415	1,612	7,003	1,523	9,887	2,149	6,179	1,075	5,767	878	
		40	0.2	5,931	1,156	5,338	1,040	5,042	982	7,116	1,386	4,449	693	4,152	566	
	0.5	20	0.35	8,239	1,791	7,415	1,612	7,003	1,523	9,887	2,149	6,179	1,075	5,767	878	
		40	0.135	5,931	1,156	5,338	1,040	5,042	982	7,116	1,386	4,449	693	4,152	566	
	1	20	0.4	8,239	1,791	7,415	1,612	7,003	1,523	9,887	2,149	6,179	1,075	5,767	878	
		40	0.15	5,931	1,156	5,338	1,040	5,042	982	7,116	1,386	4,449	693	4,152	566	
	6	0.1	12	0.08	6,867	1,792	6,181	1,612	5,837	1,523	8,240	2,150	5,150	1,075	4,808	878
			18	0.065	6,867	1,792	6,181	1,612	5,837	1,523	8,240	2,150	5,150	1,075	4,808	878
24			0.06	6,867	1,792	6,181	1,612	5,837	1,523	8,240	2,150	5,150	1,075	4,808	878	
35			0.05	5,837	1,371	5,253	1,234	4,962	1,165	7,005	1,644	4,379	823	4,086	671	
55			0.04	4,942	945	4,449	851	4,201	803	5,931	1,134	3,706	561	3,460	457	
0.2		12	0.16	6,867	1,792	6,181	1,612	5,837	1,523	8,240	2,150	5,150	1,075	4,808	878	
		18	0.14	6,867	1,792	6,181	1,612	5,837	1,523	8,240	2,150	5,150	1,075	4,808	878	
		24	0.13	6,867	1,792	6,181	1,612	5,837	1,523	8,240	2,150	5,150	1,075	4,808	878	
		35	0.11	5,837	1,371	5,253	1,234	4,962	1,165	7,005	1,644	4,379	823	4,086	671	
		55	0.08	4,942	945	4,449	851	4,201	803	5,931	1,134	3,706	561	3,460	457	
0.3		12	0.24	6,867	1,792	6,181	1,612	5,837	1,523	8,240	2,150	5,150	1,075	4,808	878	
		18	0.22	6,867	1,792	6,181	1,612	5,837	1,523	8,240	2,150	5,150	1,075	4,808	878	
		24	0.2	6,867	1,792	6,181	1,612	5,837	1,523	8,240	2,150	5,150	1,075	4,808	878	
		35	0.18	5,837	1,371	5,253	1,234	4,962	1,165	7,005	1,644	4,379	823	4,086	671	
		55	0.14	4,942	945	4,449	851	4,201	803	5,931	1,134	3,706	561	3,460	457	
0.5		18	0.35	6,867	1,792	6,181	1,612	5,837	1,523	8,240	2,150	5,150	1,075	4,808	878	
		24	0.29	6,867	1,792	6,181	1,612	5,837	1,523	8,240	2,150	5,150	1,075	4,808	878	

【Note】 Please refer to P.501

Recommended Cutting Datas to High Accuracy Machining

SPM200-RN2

2 Flute, Extended Neck-Corner Radius End Mill

» continue

Workpiece Materials				P						N		H			
				Carbon Steel, Alloy Steel (180 ~ 250HB)		Alloy Steels, Tool Steels (25 ~ 35HRC)		PH, Ferrite, Martensite Steels (35 ~ 45HRC)		Copper, Copper Alloys		Hardened Steels (45 ~ 55HRC)		Hardened Steels (55 ~ 65HRC)	
Ratio to standard depth of cut (ap)				1.00		0.90		0.70		1.20		0.50		0.45	
Mill Dia. (mm)	r (mm)	Under Neck Length (mm)	ap	n r/min	Vf mm/min	n r/min	Vf mm/min	n r/min	Vf mm/min	n r/min	Vf mm/min	n r/min	Vf mm/min	n r/min	Vf mm/min
6	0.5	35	0.24	5,837	1,371	5,253	1,234	4,962	1,165	7,005	1,644	4,379	823	4,086	671
		55	0.165	4,942	945	4,449	851	4,201	803	5,931	1,134	3,706	561	3,460	457
	1	18	0.4	6,867	1,792	6,181	1,612	5,837	1,523	8,240	2,150	5,150	1,075	4,808	878
		24	0.35	6,867	1,792	6,181	1,612	5,837	1,523	8,240	2,150	5,150	1,075	4,808	878
		35	0.28	5,837	1,371	5,253	1,234	4,962	1,165	7,005	1,644	4,379	823	4,086	671
		55	0.2	4,942	945	4,449	851	4,201	803	5,931	1,134	3,706	561	3,460	457

【Note】

- For different materials, adjust the cutting depth (ap) according to the cutting depth factors in the above table. E.g. for hardened steels (45 ~ 55HRC), ap*0.5.
- Use the appropriate coolant such as air cooling or emulsion for the work material and machining shape.
- In actual machining, the condition should be adjusted according to the machining shape, purpose and the machine type.
- If the rpm of the machine is low, lower the feed rate also to put the rpm and feed rate in the same ratio.

Recommended Cutting Datas to General Machining

SPM200-BN2

2 Flute, Extended Neck-Ball Nose End Mill

Workpiece Materials				P				N		H					
				Carbon Steel, Alloy Steel(180 ~ 250HB)		Alloy Steels, Tool Steels(25 ~ 35HRC)		PH, Ferrite, Martensite Steels(35 ~ 45HRC)		Copper, Copper Alloys		Hardened Steels (45 ~ 55HRC)		Hardened Steels (55 ~ 65HRC)	
Ratio to standard depth of cut(ap)				1.00		0.90		0.70		1.20		0.50		0.45	
R (mm)	Mill Dia. (mm)	Under Neck Length (mm)	ap	n r/min	Vf mm/min	n r/min	Vf mm/min	n r/min	Vf mm/min	n r/min	Vf mm/min	n r/min	Vf mm/min	n r/min	Vf mm/min
0.05	0.1	0.2	0.008	50,000	250	50,000	250	50,000	225	50,000	300	50,000	200	50,000	188
		0.3	0.006	50,000	250	50,000	250	50,000	225	50,000	300	50,000	200	50,000	188
		0.5	0.004	50,000	250	50,000	250	50,000	225	50,000	300	50,000	200	50,000	188
0.1	0.2	0.5	0.02	45,000	315	45,000	315	45,000	293	45,000	378	40,950	246	37,800	189
		0.75	0.017	45,000	315	45,000	315	45,000	293	45,000	378	40,950	246	37,800	189
		1	0.014	45,000	315	45,000	315	45,000	293	45,000	378	40,950	246	37,800	189
		1.25	0.011	45,000	284	43,740	275	41,310	242	45,000	340	36,450	197	34,020	153
		1.5	0.008	45,000	284	43,740	275	41,310	242	45,000	340	36,450	197	34,020	153
		2	0.008	45,000	284	43,740	275	41,310	242	45,000	340	36,450	197	34,020	153
		2.5	0.006	43,200	242	38,880	218	36,720	191	43,200	291	32,400	156	30,240	121
		3	0.004	43,200	242	38,880	218	36,720	191	43,200	291	32,400	156	30,240	121
0.15	0.3	0.5	0.027	45,000	450	45,000	450	45,000	405	45,000	540	40,500	345	37,800	302
		0.75	0.024	45,000	450	45,000	450	45,000	405	45,000	540	40,500	345	37,800	302
		1	0.021	45,000	450	45,000	450	45,000	405	45,000	540	40,500	345	37,800	302
		1.25	0.019	45,000	450	45,000	450	45,000	405	45,000	540	40,500	345	37,800	302
		1.5	0.016	45,000	450	45,000	450	45,000	405	45,000	540	40,500	345	37,800	302
		2	0.012	45,000	405	43,740	393	41,310	335	45,000	486	36,450	279	34,020	245
		2.5	0.01	45,000	405	43,740	393	41,310	335	45,000	486	36,450	279	34,020	245
		3	0.008	45,000	405	43,740	393	41,310	335	45,000	486	36,450	279	34,020	245
0.2	0.4	0.75	0.043	45,000	756	45,000	755	45,000	693	45,000	870	42,120	590	39,312	551
		1	0.04	45,000	756	45,000	755	45,000	693	45,000	870	42,120	590	39,312	551
		1.5	0.034	45,000	648	45,000	647	45,000	594	45,000	746	42,120	421	39,312	393
		2	0.028	45,000	540	45,000	540	45,000	495	45,000	622	42,120	421	39,312	393
		2.5	0.022	38,880	420	34,992	378	33,048	328	45,000	504	29,160	263	32,659	245
		3	0.016	38,880	420	34,992	378	33,048	328	45,000	504	29,160	263	32,659	245
		3.5	0.012	38,880	420	34,992	378	33,048	328	45,000	504	29,160	263	32,659	245
		4	0.01	38,880	420	34,992	378	33,048	328	45,000	504	29,160	263	32,659	245
0.25	0.5	1	0.045	45,000	1,350	42,120	1,264	39,780	1,074	45,000	1,350	35,100	948	32,760	669
		1.5	0.04	45,000	1,350	42,120	1,264	39,780	1,074	45,000	1,350	35,100	948	32,760	613
		2	0.035	45,000	1,080	42,120	1,011	39,780	860	45,000	1,080	35,100	758	32,760	613
		2.5	0.033	45,000	900	37,908	682	35,802	581	45,000	973	31,590	511	29,484	452

[Note] Please refer to P.512

Recommended Cutting Datas to General Machining

SPM200-BN2

2 Flute, Extended Neck-Ball Nose End Mill

» continue

Workpiece Materials				P						N		H			
				Carbon Steel, Alloy Steel(180 ~ 250HB)		Alloy Steels, Tool Steels(25 ~ 35HRC)		PH, Ferrite, Martensite Steels(35 ~ 45HRC)		Copper, Copper Alloys		Hardened Steels (45 ~ 55HRC)		Hardened Steels (55 ~ 65HRC)	
Ratio to standard depth of cut(ap)				1.00		0.90		0.70		1.20		0.50		0.45	
R (mm)	Mill Dia. (mm)	Under Neck Length (mm)	ap	n r/min	Vf mm/min	n r/min	Vf mm/min	n r/min	Vf mm/min	n r/min	Vf mm/min	n r/min	Vf mm/min	n r/min	Vf mm/min
0.25	0.5	3	0.03	42,120	758	37,908	682	35,802	581	45,000	810	31,590	511	22,680	347
		4	0.02	32,400	583	29,160	525	27,540	446	38,880	700	29,160	472	22,680	347
		5	0.018	32,400	583	29,160	525	27,540	446	38,880	700	29,160	472	22,680	347
		5.5	0.015	28,800	490	25,920	441	24,480	374	34,560	588	21,600	330	20,160	292
		6	0.013	28,800	490	25,920	441	24,480	374	34,560	588	21,600	330	20,160	292
		8	0.008	28,800	490	25,920	441	24,480	374	34,560	588	21,600	330	20,160	292
0.3	0.6	1	0.075	45,000	2,025	45,000	2,025	45,000	1,755	45,000	2,025	43,200	1,555	40,320	1,210
		2	0.063	45,000	2,025	45,000	2,025	45,000	1,755	45,000	2,025	43,200	1,555	40,320	1,210
		2.5	0.046	45,000	1,620	45,000	1,620	45,000	1,404	45,000	1,620	43,200	1,244	40,320	887
		3	0.041	45,000	1,620	45,000	1,620	45,000	1,404	45,000	1,620	43,200	1,244	40,320	887
		3.5	0.035	45,000	1,539	45,000	1,538	44,064	1,307	45,000	1,539	38,880	1,065	36,288	759
		4	0.026	45,000	1,539	45,000	1,538	44,064	1,307	45,000	1,539	38,880	1,065	36,288	689
		4.5	0.022	45,000	1,215	43,740	1,182	41,310	967	45,000	1,215	36,450	788	34,020	613
		5	0.02	42,120	1,138	37,908	1,024	35,802	838	45,000	1,215	31,590	682	29,484	531
		5.5	0.017	42,120	1,138	37,908	1,024	35,802	838	45,000	1,215	31,590	682	29,484	531
		6	0.015	42,120	1,138	37,908	1,024	35,802	838	45,000	1,215	31,590	682	29,484	531
		7	0.015	28,800	734	25,920	793	24,480	541	34,560	881	21,600	441	20,160	446
		8	0.015	28,800	734	25,920	661	24,480	541	34,560	881	21,600	441	20,160	343
9	0.012	28,800	734	25,920	661	24,480	541	34,560	881	21,600	441	20,160	343		
10	0.009	25,200	643	22,680	579	21,420	473	30,240	771	18,900	385	17,640	300		
12	0.007	21,600	518	19,440	466	18,360	382	25,920	622	16,200	311	15,120	242		
0.35	0.7	2	0.092	45,000	2,228	45,000	2,228	45,000	1,940	45,000	2,228	43,200	1,739	37,800	1,069
		4	0.041	45,000	1,692	45,000	1,692	44,064	1,443	45,000	1,692	38,880	1,189	34,020	761
		6	0.027	42,120	1,251	37,908	1,126	35,802	925	45,000	1,337	31,590	763	27,216	577
		8	0.02	28,800	760	25,920	684	24,480	563	34,560	912	21,600	464	20,160	380
0.4	0.8	2	0.12	45,000	2,430	45,000	2,430	45,000	2,160	45,000	2,430	43,200	2,333	40,320	1,694
		4	0.078	45,000	2,430	45,000	2,430	45,000	2,160	45,000	2,430	43,200	2,333	40,320	1,694
		5	0.059	45,000	2,186	45,000	2,188	44,064	1,903	45,000	2,188	38,880	1,911	36,288	1,372
		6	0.042	45,000	2,040	40,824	1,852	38,556	1,554	45,000	2,042	34,020	1,286	31,752	1,121
		8	0.02	37,440	1,213	33,696	1,092	31,824	916	44,928	1,455	28,080	758	26,208	660
10	0.02	28,800	881	25,920	793	24,480	666	34,560	1,058	21,600	551	20,160	480		
0.45	0.9	2	0.135	45,000	2,877	45,000	2,877	45,000	2,539	45,000	2,877	41,040	2,170	38,304	1,924

【Note】 Please refer to P.512

Recommended Cutting Datas to General Machining

SPM200-BN2

2 Flute, Extended Neck-Ball Nose End Mill

» continue

Workpiece Materials				P						N		H			
				Carbon Steel, Alloy Steel(180 ~ 250HB)		Alloy Steels, Tool Steels(25 ~ 35HRC)		PH, Ferrite, Martensite Steels(35 ~ 45HRC)		Copper, Copper Alloys		Hardened Steels (45 ~ 55HRC)		Hardened Steels (55 ~ 65HRC)	
Ratio to standard depth of cut(ap)				1.00		0.90		0.70		1.20		0.50		0.45	
R (mm)	Mill Dia. (mm)	Under Neck Length (mm)	ap	n r/min	Vf mm/min	n r/min	Vf mm/min	n r/min	Vf mm/min	n r/min	Vf mm/min	n r/min	Vf mm/min	n r/min	Vf mm/min
0.45	0.9	4	0.081	45,000	2,494	45,000	2,494	43,605	2,132	45,000	2,494	38,475	1,763	35,910	1,563
		6	0.05	43,092	1,818	38,783	1,636	36,628	1,364	45,000	2,072	32,319	1,128	30,164	1,000
		8	0.036	32,832	1,259	29,549	1,133	27,907	944	39,398	1,511	24,624	781	22,982	693
0.5	1	2	0.2	45,000	3,375	43,740	3,281	41,310	2,788	45,000	3,375	38,880	2,450	34,020	2,041
		3	0.2	45,000	3,375	43,740	3,281	41,310	2,788	45,000	3,375	38,880	2,450	34,020	2,041
		4	0.14	45,000	3,375	43,740	3,281	41,310	2,788	45,000	3,375	38,880	2,450	34,020	2,041
		5	0.09	42,120	2,948	37,908	2,653	35,802	2,336	45,000	3,150	38,880	2,286	29,484	1,652
		6	0.06	37,908	2,389	36,742	2,302	34,700	2,087	45,000	2,836	34,992	2,118	26,536	1,241
		7	0.06	34,992	1,575	31,493	1,417	29,743	1,204	41,990	1,890	28,431	1,191	24,494	955
		8	0.06	34,992	1,575	31,493	1,417	29,743	1,204	41,990	1,890	28,431	1,191	24,494	881
		9	0.045	34,992	1,575	31,493	1,417	29,743	1,204	41,990	1,890	28,431	1,191	24,494	881
		10	0.038	34,992	1,575	31,493	1,417	29,743	1,204	41,990	1,890	28,431	1,191	24,494	881
		12	0.025	25,920	1,102	23,328	992	22,032	842	31,104	1,322	19,440	694	18,144	617
		13	0.023	25,920	1,102	23,328	992	22,032	842	31,104	1,322	19,440	694	18,144	617
		14	0.02	25,920	1,102	23,328	992	22,032	842	31,104	1,322	19,440	694	18,144	617
16	0.015	25,920	1,102	23,328	992	22,032	842	31,104	1,322	19,440	694	18,144	617		
18	0.012	22,680	907	20,412	816	19,278	694	27,216	1,089	17,010	572	15,876	508		
20	0.01	19,440	778	17,496	700	16,524	595	23,328	933	14,580	490	13,608	436		
0.55	1.1	2	0.2	45,000	3,532	40,824	3,204	38,556	2,634	45,000	3,532	34,020	2,207	31,752	1,958
		4	0.14	45,000	3,532	40,824	3,204	38,556	2,634	45,000	3,532	34,020	2,207	31,752	1,958
		6	0.06	35,802	2,075	32,222	1,868	30,432	1,535	42,962	2,490	26,852	1,287	25,061	1,141
		8	0.06	35,802	2,075	32,222	1,556	28,091	1,181	42,962	2,075	24,786	990	23,134	878
		10	0.038	35,802	1,597	32,222	1,556	28,091	1,181	42,962	2,075	24,786	990	23,134	878
0.6	1.2	4	0.16	41,539	3,369	37,384	2,934	35,307	2,445	45,000	3,532	33,231	2,300	29,076	1,674
		8	0.06	33,696	1,928	30,326	1,893	28,642	1,862	40,435	2,313	27,216	1,856	23,587	943
		10	0.053	31,104	1,537	27,994	1,310	26,438	1,190	37,325	1,746	24,300	962	21,773	784
		12	0.045	31,104	1,456	27,994	1,310	26,438	1,190	37,325	1,746	23,328	923	21,773	784
0.7	1.4	8	0.11	29,484	2,123	26,536	1,911	25,061	1,625	35,381	2,547	22,113	1,380	20,639	1,238
		12	0.053	27,216	1,470	24,494	1,323	23,134	1,124	32,659	1,764	20,412	956	19,051	858
		16	0.035	20,160	1,028	18,144	925	17,136	787	24,192	1,234	15,120	669	14,112	599
0.75	1.5	4	0.2	37,800	3,742	34,020	3,368	32,130	2,892	45,000	4,456	28,350	2,297	26,460	1,985
		6	0.2	37,800	3,742	34,020	3,368	32,130	2,892	45,000	4,456	28,350	2,297	26,460	1,985
		8	0.09	29,484	2,364	26,536	1,891	25,061	1,625	35,381	2,522	22,113	1,291	20,639	1,115

[Note] Please refer to P.512

Recommended Cutting Datas to General Machining

SPM200-BN2

2 Flute, Extended Neck-Ball Nose End Mill

» continue

Workpiece Materials				P						N		H			
				Carbon Steel, Alloy Steel(180 ~ 250HB)		Alloy Steels, Tool Steels(25 ~ 35HRC)		PH, Ferrite, Martensite Steels(35 ~ 45HRC)		Copper, Copper Alloys		Hardened Steels (45 ~ 55HRC)		Hardened Steels (55 ~ 65HRC)	
Ratio to standard depth of cut(ap)				1.00		0.90		0.70		1.20		0.50		0.45	
R (mm)	Mill Dia. (mm)	Under Neck Length (mm)	ap	n r/min	Vf mm/min	n r/min	Vf mm/min	n r/min	Vf mm/min	n r/min	Vf mm/min	n r/min	Vf mm/min	n r/min	Vf mm/min
0.75	1.5	10	0.09	27,216	1,940	24,494	1,746	23,134	1,499	32,659	2,327	20,412	1,191	19,051	1,029
		12	0.09	27,216	1,616	24,494	1,454	23,134	1,249	32,659	1,940	20,412	993	19,051	858
		14	0.075	27,216	1,616	21,773	1,221	20,563	1,049	29,030	1,629	18,144	833	16,934	719
		16	0.038	20,160	1,131	18,144	1,018	17,136	874	24,192	1,357	15,120	694	14,112	599
		18	0.038	20,160	1,131	18,144	1,018	17,136	874	24,192	1,357	15,120	694	14,112	599
		20	0.038	20,160	1,131	18,144	1,018	17,136	874	24,192	1,357	15,120	694	14,112	599
0.8	1.6	8	0.22	32,760	2,752	29,484	2,477	27,846	2,244	39,312	3,302	24,570	1,916	21,294	1,431
		12	0.098	29,484	2,600	26,536	2,341	25,061	1,958	35,381	3,120	22,113	1,672	19,165	1,160
		16	0.06	25,272	1,592	22,745	1,433	21,481	1,199	30,326	1,911	18,954	1,024	17,690	892
		20	0.04	18,720	1,114	16,848	1,003	15,912	839	22,464	1,337	14,040	716	13,104	624
0.9	1.8	8	0.26	30,420	2,921	27,378	2,628	25,857	2,172	36,504	3,505	22,815	1,807	21,294	1,534
		12	0.105	25,272	1,820	22,745	1,637	21,481	1,354	30,326	2,183	18,954	1,125	17,690	956
		16	0.068	25,272	1,820	22,745	1,637	21,481	1,354	30,326	2,183	18,954	1,125	17,690	956
		20	0.045	18,720	1,273	16,848	1,146	15,912	947	22,464	1,527	14,040	788	13,104	669
1	2	3	0.4	28,350	4,253	25,515	3,828	24,098	3,254	34,020	5,103	21,263	2,744	19,845	2,381
		4	0.4	28,350	4,253	25,515	3,828	24,098	3,254	34,020	5,103	21,263	2,744	19,845	2,381
		6	0.4	28,350	3,828	25,515	3,444	24,098	2,892	34,020	4,593	21,263	2,424	19,845	2,143
		8	0.28	28,350	3,828	25,515	3,444	24,098	2,892	34,020	4,593	21,263	2,424	19,845	2,143
		10	0.21	26,460	3,175	23,814	2,858	22,491	2,429	31,752	3,811	19,845	2,024	17,199	1,321
		12	0.12	23,814	2,858	21,433	2,572	20,242	2,187	28,577	3,428	17,861	1,846	15,479	1,189
		13	0.12	23,814	2,858	21,433	2,572	20,242	2,187	28,577	3,428	17,861	1,822	14,288	914
		14	0.12	23,814	2,477	21,433	2,229	20,242	1,895	28,577	2,971	16,585	1,466	14,288	914
		16	0.12	22,113	1,592	19,902	1,434	18,797	1,218	26,536	1,911	16,585	1,320	14,288	823
		18	0.09	20,412	1,470	18,371	1,323	17,350	1,124	24,494	1,764	16,585	1,219	14,288	823
		20	0.075	20,412	1,470	18,371	1,323	17,350	1,124	24,494	1,764	16,585	1,015	14,288	823
		22	0.05	16,065	1,093	14,459	983	13,656	836	19,278	1,311	12,049	697	13,495	734
		25	0.05	15,120	1,028	13,608	925	12,852	787	18,144	1,234	11,340	655	12,701	691
		30	0.03	15,120	1,028	13,608	925	12,852	787	18,144	1,234	11,340	655	12,701	691
35	0.025	13,230	847	11,907	762	11,246	648	15,876	1,016	9,923	540	9,261	474		
40	0.022	11,340	725	10,206	653	9,639	555	13,608	871	8,505	463	7,938	407		
1.25	2.5	6	0.5	24,975	4,557	22,478	4,100	21,229	3,417	29,970	5,468	18,732	2,779	17,483	2,278
		10	0.34	24,975	4,557	22,478	4,100	21,229	3,417	29,970	5,468	18,732	2,779	17,483	2,278
		15	0.15	19,481	2,558	17,533	2,302	16,558	1,919	23,377	3,070	14,611	1,821	13,637	1,279

【Note】 Please refer to P.512

Recommended Cutting Datas to General Machining

SPM200-BN2

2 Flute, Extended Neck-Ball Nose End Mill

» continue

Workpiece Materials				P						N		H			
				Carbon Steel, Alloy Steel (180 ~ 250HB)		Alloy Steels, Tool Steels (25 ~ 35HRC)		PH, Ferrite, Martensite Steels (35 ~ 45HRC)		Copper, Copper Alloys		Hardened Steels (45 ~ 55HRC)		Hardened Steels (55 ~ 65HRC)	
Ratio to standard depth of cut (ap)				1.00		0.90		0.70		1.20		0.50		0.45	
R (mm)	Mill Dia. (mm)	Under Neck Length (mm)	ap	n r/min	Vf mm/min	n r/min	Vf mm/min	n r/min	Vf mm/min	n r/min	Vf mm/min	n r/min	Vf mm/min	n r/min	Vf mm/min
1.25	2.5	20	0.12	17,982	1,967	16,184	1,771	15,285	1,476	21,578	2,362	14,611	1,301	12,587	984
		25	0.098	17,982	1,770	16,184	1,593	15,285	1,328	21,578	2,124	13,487	1,080	12,587	885
		30	0.055	13,320	1,377	11,988	1,239	11,322	1,033	15,984	1,652	9,990	840	9,324	689
1.5	3	8	0.6	21,600	4,860	19,440	4,374	18,360	3,690	25,920	5,832	16,200	3,062	15,120	2,722
		10	0.42	21,600	4,860	19,440	4,374	18,360	3,690	25,920	5,832	16,200	3,062	15,120	2,722
		13	0.315	20,160	3,629	18,144	3,266	17,136	2,755	24,192	4,354	15,120	2,286	14,112	2,032
		16	0.315	20,160	3,266	18,144	2,939	17,136	2,480	24,192	3,920	15,120	2,057	13,104	1,699
		20	0.18	16,848	2,274	15,163	2,048	14,321	1,727	20,218	2,730	12,636	1,434	10,886	1,176
		25	0.12	16,848	2,274	15,163	2,048	14,321	1,727	20,218	2,730	12,636	1,434	10,886	1,176
		30	0.12	15,552	2,100	13,997	1,890	13,219	1,594	18,662	2,520	11,664	1,323	10,886	1,176
1.75	3.5	15	0.36	16,088	3,299	14,479	2,969	13,675	2,475	19,305	3,959	12,065	2,012	11,262	1,650
		25	0.21	13,365	2,052	12,029	1,847	11,361	1,539	16,038	2,462	10,024	1,252	9,356	1,026
		35	0.09	13,365	2,052	12,029	1,847	11,361	1,539	16,038	2,462	10,024	1,252	9,356	1,026
		45	0.09	9,900	1,438	8,910	1,294	8,415	1,079	11,880	1,726	7,425	878	6,930	719
2	4	10	0.6	15,525	4,658	13,973	4,192	13,197	3,564	18,630	5,589	11,644	2,969	10,868	2,608
		13	0.48	15,525	4,658	13,973	4,192	13,197	3,564	18,630	5,589	11,644	2,969	10,868	2,608
		16	0.42	15,525	4,658	13,973	4,192	13,197	3,564	18,630	5,589	11,644	2,969	10,868	2,608
		20	0.42	13,455	3,229	12,110	2,906	11,437	2,471	16,146	3,875	10,092	2,058	9,419	1,808
		25	0.24	12,110	2,615	10,899	2,354	10,293	2,001	14,531	3,139	9,083	1,946	8,477	1,464
		30	0.16	11,178	2,012	10,060	1,811	9,502	1,539	13,414	2,415	8,384	1,283	7,825	1,127
		35	0.1	11,178	2,012	10,060	1,811	9,502	1,539	13,414	2,415	8,384	1,283	7,825	1,127
		40	0.1	11,178	2,012	10,060	1,811	9,502	1,539	13,414	2,415	8,384	1,283	7,825	1,127
		45	0.1	8,280	1,408	7,452	1,267	7,038	1,076	9,936	1,689	6,210	897	5,796	788
2.5	5	20	0.525	11,340	4,082	10,206	3,674	9,639	2,892	13,608	4,899	8,505	2,552	7,938	2,143
		25	0.525	10,530	3,285	9,477	3,412	8,951	2,686	12,636	4,549	7,898	2,370	7,371	1,990
		30	0.3	9,477	2,502	8,529	3,072	8,056	2,417	11,372	4,094	7,108	2,132	6,634	1,792
		40	0.2	8,748	1,890	7,873	1,701	7,436	1,338	10,498	2,268	6,561	1,182	6,124	993
3	6	12	0.6	12,150	5,103	10,935	4,593	10,328	3,828	14,580	6,124	9,113	3,113	8,505	2,552
		20	0.5	11,475	4,476	10,328	4,028	9,754	3,356	13,770	5,370	8,607	2,730	8,033	2,237
		30	0.42	9,360	2,696	8,424	2,426	7,956	1,910	11,232	3,235	7,020	1,825	6,552	1,415
		50	0.15	7,776	2,015	6,998	1,814	6,610	1,428	9,331	2,418	5,832	1,260	5,443	1,058

[Note] Please refer to P.512

Recommended Cutting Datas to High Accuracy Machining

SPM200-BN2

2 Flute, Extended Neck-Ball Nose End Mill

Workpiece Materials				P						N		H			
				Carbon Steel, Alloy Steel(180 ~ 250HB)		Alloy Steels, Tool Steels(25 ~ 35HRC)		PH, Ferrite, Martensite Steels(35 ~ 45HRC)		Copper, Copper Alloys		Hardened Steels (45 ~ 55HRC)		Hardened Steels (55 ~ 65HRC)	
Ratio to standard depth of cut(ap)				1.00		0.90		0.70		1.20		0.50		0.45	
R (mm)	Mill Dia. (mm)	Under Neck Length (mm)	ap	n r/min	Vf mm/min	n r/min	Vf mm/min	n r/min	Vf mm/min	n r/min	Vf mm/min	n r/min	Vf mm/min	n r/min	Vf mm/min
0.05	0.1	0.2	0.004	50,000	250	50,000	250	50,000	225	50,000	300	50,000	200	50,000	188
		0.3	0.003	50,000	250	50,000	250	50,000	225	50,000	300	50,000	200	50,000	188
		0.5	0.002	50,000	250	50,000	250	50,000	225	50,000	300	50,000	200	50,000	188
0.1	0.2	0.5	0.015	45,000	315	45,000	315	45,000	293	45,000	378	40,950	246	37,800	189
		0.75	0.013	45,000	315	45,000	315	45,000	293	45,000	378	40,950	246	37,800	189
		1	0.011	45,000	315	45,000	315	45,000	293	45,000	378	40,950	246	37,800	189
		1.25	0.008	45,000	284	43,740	275	41,310	242	45,000	340	36,450	197	34,020	153
		1.5	0.007	45,000	284	43,740	275	41,310	242	45,000	340	36,450	197	34,020	153
		2	0.006	45,000	284	43,740	275	41,310	242	45,000	340	36,450	197	34,020	153
		2.5	0.005	43,200	242	38,880	218	36,720	191	43,200	291	32,400	156	30,240	121
3	0.003	43,200	242	38,880	218	36,720	191	43,200	291	32,400	156	30,240	121		
0.15	0.3	0.5	0.02	45,000	450	45,000	450	45,000	405	45,000	540	40,500	345	37,800	302
		0.75	0.018	45,000	450	45,000	450	45,000	405	45,000	540	40,500	345	37,800	302
		1	0.016	45,000	450	45,000	450	45,000	405	45,000	540	40,500	345	37,800	302
		1.25	0.014	45,000	450	45,000	450	45,000	405	45,000	540	40,500	345	37,800	302
		1.5	0.012	45,000	450	45,000	450	45,000	405	45,000	540	40,500	345	37,800	302
		2	0.009	45,000	405	43,740	393	41,310	335	45,000	486	36,450	279	34,020	245
		2.5	0.008	45,000	405	43,740	393	41,310	335	45,000	486	36,450	279	34,020	245
3	0.006	45,000	405	43,740	393	41,310	335	45,000	486	36,450	279	34,020	245		
0.2	0.4	0.75	0.043	43,200	518	38,880	466	36,720	404	45,000	622	32,400	324	30,240	302
		1	0.04	43,200	518	38,880	466	36,720	404	45,000	622	32,400	324	30,240	302
		1.5	0.034	43,200	518	38,880	466	36,720	404	45,000	622	32,400	324	30,240	302
		2	0.028	43,200	518	38,880	466	36,720	404	45,000	622	32,400	324	30,240	302
		2.5	0.016	38,880	420	34,992	378	33,048	328	45,000	504	29,160	263	27,216	245
		3	0.011	38,880	420	34,992	378	33,048	328	45,000	504	29,160	263	27,216	245
		3.5	0.008	38,880	420	34,992	378	33,048	328	45,000	504	29,160	263	27,216	245
		4	0.005	38,880	420	34,992	378	33,048	328	45,000	504	29,160	263	27,216	245
4.5	0.004	34,560	353	31,104	318	29,376	275	41,472	423	25,920	221	24,192	205		
0.25	0.5	1	0.045	36,000	720	32,400	648	30,600	551	43,200	864	27,000	486	25,200	428
		1.5	0.04	36,000	720	32,400	648	30,600	551	43,200	864	27,000	486	25,200	428
		2	0.035	36,000	720	32,400	648	30,600	551	43,200	864	27,000	486	25,200	428
		2.5	0.033	36,000	720	29,160	525	27,540	446	38,880	700	24,300	393	22,680	347

【Note】 Please refer to P.512

Recommended Cutting Datas to High Accuracy Machining

SPM200-BN2

2 Flute, Extended Neck-Ball Nose End Mill

» continue

Workpiece Materials				P						N		H			
				Carbon Steel, Alloy Steel(180 ~ 250HB)		Alloy Steels, Tool Steels(25 ~ 35HRC)		PH, Ferrite, Martensite Steels(35 ~ 45HRC)		Copper, Copper Alloys		Hardened Steels (45 ~ 55HRC)		Hardened Steels (55 ~ 65HRC)	
Ratio to standard depth of cut(ap)				1.00		0.90		0.70		1.20		0.50		0.45	
R (mm)	Mill Dia. (mm)	Under Neck Length (mm)	ap	n r/min	Vf mm/min	n r/min	Vf mm/min	n r/min	Vf mm/min	n r/min	Vf mm/min	n r/min	Vf mm/min	n r/min	Vf mm/min
0.25	0.5	3	0.03	32,400	583	29,160	525	27,540	446	38,880	700	24,300	393	22,680	347
		4	0.02	32,400	583	29,160	525	27,540	446	38,880	700	24,300	393	22,680	347
		5	0.018	32,400	583	29,160	525	27,540	446	38,880	700	24,300	393	22,680	347
		5.5	0.008	28,800	490	25,920	441	24,480	374	34,560	588	21,600	330	20,160	292
		6	0.007	28,800	490	25,920	441	24,480	374	34,560	588	21,600	330	20,160	292
		8	0.004	28,800	490	25,920	441	24,480	374	34,560	588	21,600	330	20,160	292
0.3	0.6	1	0.05	36,000	1,080	32,400	972	30,600	796	43,200	1,296	27,000	648	25,200	504
		2	0.042	36,000	1,080	32,400	972	30,600	796	43,200	1,296	27,000	648	25,200	504
		2.5	0.038	36,000	1,080	32,400	972	30,600	796	43,200	1,296	27,000	648	25,200	504
		3	0.034	36,000	1,080	32,400	972	30,600	796	43,200	1,296	27,000	648	25,200	504
		3.5	0.029	32,400	923	29,160	831	27,540	680	38,880	1,108	24,300	554	22,680	431
		4	0.024	32,400	923	29,160	831	27,540	680	38,880	1,108	24,300	554	22,680	431
		4.5	0.022	32,400	875	29,160	788	27,540	644	38,880	1,049	24,300	525	22,680	409
		5	0.02	32,400	875	29,160	788	27,540	644	38,880	1,049	24,300	525	22,680	409
		5.5	0.017	32,400	875	29,160	788	27,540	644	38,880	1,049	24,300	525	22,680	409
		6	0.015	32,400	875	29,160	788	27,540	644	38,880	1,049	24,300	525	22,680	409
		7	0.008	28,800	734	25,920	661	24,480	541	34,560	881	21,600	441	20,160	343
		8	0.008	28,800	734	25,920	661	24,480	541	34,560	881	21,600	441	20,160	343
9	0.006	28,800	734	25,920	661	24,480	541	34,560	881	21,600	441	20,160	343		
10	0.005	25,200	643	22,680	579	21,420	473	30,240	771	18,900	385	17,640	300		
12	0.004	21,600	518	19,440	466	18,360	382	25,920	622	16,200	311	15,120	242		
0.35	0.7	2	0.061	36,000	1,188	32,400	1,069	30,600	879	43,200	1,426	27,000	725	25,200	594
		4	0.034	32,400	1,015	29,160	914	27,540	752	38,880	1,219	24,300	619	22,680	508
		6	0.027	32,400	962	29,160	866	27,540	712	38,880	1,155	24,300	587	22,680	482
		8	0.01	28,800	760	25,920	684	24,480	563	34,560	912	21,600	464	20,160	380
0.4	0.8	2	0.08	36,000	1,296	32,400	1,166	30,600	979	43,200	1,555	27,000	810	25,200	706
		4	0.056	36,000	1,296	32,400	1,166	30,600	979	43,200	1,555	27,000	810	25,200	706
		5	0.045	32,400	1,049	29,160	945	27,540	793	38,880	1,260	24,300	656	22,680	572
		6	0.032	32,400	1,049	29,160	945	27,540	793	38,880	1,260	24,300	656	22,680	572
		8	0.02	28,800	933	25,920	840	24,480	705	34,560	1,120	21,600	583	20,160	508
		10	0.01	28,800	881	25,920	793	24,480	666	34,560	1,058	21,600	551	20,160	480
0.45	0.9	2	0.09	34,200	1,458	30,780	1,312	29,070	1,094	41,040	1,750	25,650	904	23,940	802

[Note] Please refer to P.512

Recommended Cutting Datas to High Accuracy Machining

SPM200-BN2

2 Flute, Extended Neck-Ball Nose End Mill

» continue

Workpiece Materials				P						N		H			
				Carbon Steel, Alloy Steel (180 ~ 250HB)		Alloy Steels, Tool Steels (25 ~ 35HRC)		PH, Ferrite, Martensite Steels (35 ~ 45HRC)		Copper, Copper Alloys		Hardened Steels (45 ~ 55HRC)		Hardened Steels (55 ~ 65HRC)	
Ratio to standard depth of cut (ap)				1.00		0.90		0.70		1.20		0.50		0.45	
R (mm)	Mill Dia. (mm)	Under Neck Length (mm)	ap	n r/min	Vf mm/min	n r/min	Vf mm/min	n r/min	Vf mm/min	n r/min	Vf mm/min	n r/min	Vf mm/min	n r/min	Vf mm/min
0.45	0.9	4	0.058	34,200	1,458	30,780	1,312	29,070	1,094	41,040	1,750	25,650	904	23,940	802
		6	0.042	30,780	1,181	27,702	1,063	26,163	886	36,936	1,417	23,085	732	21,546	650
		8	0.03	27,360	1,049	24,624	944	23,256	788	32,832	1,259	20,520	651	19,152	577
0.5	1	2	0.1	32,400	1,620	29,160	1,458	27,540	1,239	38,880	1,944	24,300	1,021	22,680	907
		3	0.1	32,400	1,620	29,160	1,458	27,540	1,239	38,880	1,944	24,300	1,021	22,680	907
		4	0.07	32,400	1,620	29,160	1,458	27,540	1,239	38,880	1,944	24,300	1,021	22,680	907
		5	0.06	32,400	1,620	29,160	1,458	27,540	1,239	38,880	1,944	24,300	1,021	22,680	907
		6	0.04	29,160	1,312	26,244	1,181	24,786	1,004	34,992	1,575	21,870	827	20,412	734
		7	0.04	29,160	1,312	26,244	1,181	24,786	1,004	34,992	1,575	21,870	827	20,412	734
		8	0.04	29,160	1,312	26,244	1,181	24,786	1,004	34,992	1,575	21,870	827	20,412	734
		9	0.03	29,160	1,312	26,244	1,181	24,786	1,004	34,992	1,575	21,870	827	20,412	734
		10	0.025	29,160	1,312	26,244	1,181	24,786	1,004	34,992	1,575	21,870	827	20,412	734
		12	0.013	25,920	1,102	23,328	992	22,032	842	31,104	1,322	19,440	694	18,144	617
		13	0.011	25,920	1,102	23,328	992	22,032	842	31,104	1,322	19,440	694	18,144	617
		14	0.01	25,920	1,102	23,328	992	22,032	842	31,104	1,322	19,440	694	18,144	617
		16	0.008	25,920	1,102	23,328	992	22,032	842	31,104	1,322	19,440	694	18,144	617
18	0.006	22,680	907	20,412	816	19,278	694	27,216	1,089	17,010	572	15,876	508		
20	0.005	19,440	778	17,496	700	16,524	595	23,328	933	14,580	490	13,608	436		
0.55	1.1	2	0.1	30,240	1,582	27,216	1,424	25,704	1,171	36,288	1,899	22,680	981	21,168	870
		4	0.07	30,240	1,582	27,216	1,424	25,704	1,171	36,288	1,899	22,680	981	21,168	870
		6	0.04	27,540	1,330	24,786	1,197	23,409	985	33,048	1,597	20,655	824	19,278	732
		8	0.04	27,540	1,330	24,786	1,197	23,409	985	33,048	1,597	20,655	824	19,278	732
		10	0.025	27,540	1,330	24,786	1,197	23,409	985	33,048	1,597	20,655	824	19,278	732
0.6	1.2	4	0.08	27,692	1,449	24,923	1,304	23,539	1,087	33,231	1,739	20,769	898	19,384	797
		8	0.04	25,920	1,348	23,328	1,213	22,032	992	31,104	1,617	19,440	855	18,144	725
		10	0.035	25,920	1,281	23,328	1,092	22,032	992	31,104	1,455	19,440	770	18,144	653
		12	0.03	25,920	1,213	23,328	1,092	22,032	992	31,104	1,455	19,440	770	18,144	653
0.7	1.4	8	0.055	22,680	1,361	20,412	1,225	19,278	1,041	27,216	1,633	17,010	885	15,876	794
		12	0.035	22,680	1,225	20,412	1,103	19,278	937	27,216	1,470	17,010	797	15,876	715
		16	0.017	20,160	1,028	18,144	925	17,136	787	24,192	1,234	15,120	669	14,112	599
0.75	1.5	4	0.1	25,200	1,663	22,680	1,497	21,420	1,285	30,240	1,996	18,900	1,021	17,640	882
		6	0.1	25,200	1,663	22,680	1,497	21,420	1,285	30,240	1,996	18,900	1,021	17,640	882

【Note】 Please refer to P.512

Recommended Cutting Datas to High Accuracy Machining

SPM200-BN2

2 Flute, Extended Neck-Ball Nose End Mill

» continue

Workpiece Materials				P						N		H			
				Carbon Steel, Alloy Steel (180 ~ 250HB)		Alloy Steels, Tool Steels (25 ~ 35HRC)		PH, Ferrite, Martensite Steels (35 ~ 45HRC)		Copper, Copper Alloys		Hardened Steels (45 ~ 55HRC)		Hardened Steels (55 ~ 65HRC)	
Ratio to standard depth of cut (ap)				1.00		0.90		0.70		1.20		0.50		0.45	
R (mm)	Mill Dia. (mm)	Under Neck Length (mm)	ap	n r/min	Vf mm/min	n r/min	Vf mm/min	n r/min	Vf mm/min	n r/min	Vf mm/min	n r/min	Vf mm/min	n r/min	Vf mm/min
0.75	1.5	8	0.06	22,680	1,347	20,412	1,212	19,278	1,041	27,216	1,616	17,010	827	15,876	715
		10	0.06	22,680	1,347	20,412	1,212	19,278	1,041	27,216	1,616	17,010	827	15,876	715
		12	0.06	22,680	1,347	20,412	1,212	19,278	1,041	27,216	1,616	17,010	827	15,876	715
		14	0.05	22,680	1,347	18,144	1,018	17,136	874	24,192	1,357	15,120	694	14,112	599
		16	0.019	20,160	1,131	18,144	1,018	17,136	874	24,192	1,357	15,120	694	14,112	599
		18	0.019	20,160	1,131	18,144	1,018	17,136	874	24,192	1,357	15,120	694	14,112	599
		20	0.019	20,160	1,131	18,144	1,018	17,136	874	24,192	1,357	15,120	694	14,112	599
0.8	1.6	8	0.11	23,400	1,638	21,060	1,474	19,890	1,233	28,080	1,966	17,550	1,053	16,380	917
		12	0.065	21,060	1,327	18,954	1,194	17,901	999	25,272	1,592	15,795	853	14,742	743
		16	0.04	21,060	1,327	18,954	1,194	17,901	999	25,272	1,592	15,795	853	14,742	743
		20	0.02	18,720	1,114	16,848	1,003	15,912	839	22,464	1,337	14,040	716	13,104	624
0.9	1.8	8	0.13	23,400	1,872	21,060	1,685	19,890	1,392	28,080	2,246	17,550	1,158	16,380	983
		12	0.07	21,060	1,517	18,954	1,364	17,901	1,128	25,272	1,820	15,795	938	14,742	797
		16	0.045	21,060	1,517	18,954	1,364	17,901	1,128	25,272	1,820	15,795	938	14,742	797
		20	0.022	18,720	1,273	16,848	1,146	15,912	947	22,464	1,527	14,040	788	13,104	669
1	2	3	0.2	18,900	1,890	17,010	1,701	16,065	1,446	22,680	2,268	14,175	1,220	13,230	1,058
		4	0.2	18,900	1,890	17,010	1,701	16,065	1,446	22,680	2,268	14,175	1,220	13,230	1,058
		6	0.2	18,900	1,701	17,010	1,531	16,065	1,285	22,680	2,041	14,175	1,077	13,230	952
		8	0.14	18,900	1,701	17,010	1,531	16,065	1,285	22,680	2,041	14,175	1,077	13,230	952
		10	0.14	18,900	1,512	17,010	1,361	16,065	1,157	22,680	1,814	14,175	964	13,230	847
		12	0.08	17,010	1,361	15,309	1,225	14,459	1,041	20,412	1,633	12,758	868	11,907	762
		13	0.08	17,010	1,361	15,309	1,225	14,459	1,041	20,412	1,633	12,758	868	11,907	762
		14	0.08	17,010	1,361	15,309	1,225	14,459	1,041	20,412	1,633	12,758	868	11,907	762
		16	0.08	17,010	1,225	15,309	1,103	14,459	937	20,412	1,470	12,758	781	11,907	686
		18	0.06	17,010	1,225	15,309	1,103	14,459	937	20,412	1,470	12,758	781	11,907	686
		20	0.05	17,010	1,225	15,309	1,103	14,459	937	20,412	1,470	12,758	781	11,907	686
		22	0.042	16,065	1,093	14,459	983	13,656	836	19,278	1,311	12,049	697	11,246	612
		25	0.035	15,120	1,028	13,608	925	12,852	787	18,144	1,234	11,340	655	10,584	576
		30	0.015	15,120	1,028	13,608	925	12,852	787	18,144	1,234	11,340	655	10,584	576
35	0.012	13,230	847	11,907	762	11,246	648	15,876	1,016	9,923	540	9,261	474		
40	0.01	11,340	725	10,206	653	9,639	555	13,608	871	8,505	463	7,938	407		
1.25	2.5	6	0.25	16,650	2,025	14,985	1,823	14,153	1,519	19,980	2,430	12,488	1,236	11,655	1,013

[Note] Please refer to P.512

Recommended Cutting Datas to High Accuracy Machining

SPM200-BN2

2 Flute, Extended Neck-Ball Nose End Mill

» continue

Workpiece Materials				P						N		H			
				Carbon Steel, Alloy Steel(180 ~ 250HB)		Alloy Steels, Tool Steels(25 ~ 35HRC)		PH, Ferrite, Martensite Steels(35 ~ 45HRC)		Copper, Copper Alloys		Hardened Steels (45 ~ 55HRC)		Hardened Steels (55 ~ 65HRC)	
Ratio to standard depth of cut(ap)				1.00		0.90		0.70		1.20		0.50		0.45	
R (mm)	Mill Dia. (mm)	Under Neck Length (mm)	ap	n r/min	Vf mm/min	n r/min	Vf mm/min	n r/min	Vf mm/min	n r/min	Vf mm/min	n r/min	Vf mm/min	n r/min	Vf mm/min
1.25	2.5	10	0.17	16,650	2,025	14,985	1,823	14,153	1,519	19,980	2,430	12,488	1,236	11,655	1,013
		15	0.1	14,985	1,640	13,487	1,476	12,738	1,230	17,982	1,967	11,239	1,000	10,490	820
		20	0.08	14,985	1,640	13,487	1,476	12,738	1,230	17,982	1,967	11,239	1,000	10,490	820
		25	0.065	14,985	1,475	13,487	1,328	12,738	1,106	17,982	1,770	11,239	900	10,490	738
		30	0.044	13,320	1,377	11,988	1,239	11,322	1,033	15,984	1,652	9,990	840	9,324	689
1.5	3	8	0.3	14,400	2,160	12,960	1,944	12,240	1,640	17,280	2,592	10,800	1,361	10,080	1,210
		10	0.21	14,400	2,160	12,960	1,944	12,240	1,640	17,280	2,592	10,800	1,361	10,080	1,210
		13	0.21	14,400	2,160	12,960	1,944	12,240	1,640	17,280	2,592	10,800	1,361	10,080	1,210
		16	0.21	14,400	1,944	12,960	1,750	12,240	1,476	17,280	2,333	10,800	1,225	10,080	1,089
		20	0.12	12,960	1,750	11,664	1,575	11,016	1,328	15,552	2,100	9,720	1,103	9,072	980
		25	0.08	12,960	1,750	11,664	1,575	11,016	1,328	15,552	2,100	9,720	1,103	9,072	980
		30	0.08	12,960	1,750	11,664	1,575	11,016	1,328	15,552	2,100	9,720	1,103	9,072	980
		35	0.064	11,520	1,469	10,368	1,322	9,792	1,115	13,824	1,762	8,640	925	8,064	823
1.75	3.5	15	0.24	12,375	2,115	11,138	1,904	10,519	1,587	14,850	2,538	9,282	1,291	8,663	1,058
		25	0.14	11,138	1,710	10,024	1,539	9,467	1,283	13,365	2,052	8,353	1,043	7,797	855
		35	0.09	11,138	1,710	10,024	1,539	9,467	1,283	13,365	2,052	8,353	1,043	7,797	855
		45	0.072	9,900	1,438	8,910	1,294	8,415	1,079	11,880	1,726	7,425	878	6,930	719
2	4	10	0.4	10,350	2,070	9,315	1,863	8,798	1,584	12,420	2,484	7,763	1,319	7,245	1,159
		13	0.32	10,350	2,070	9,315	1,863	8,798	1,584	12,420	2,484	7,763	1,319	7,245	1,159
		16	0.28	10,350	2,070	9,315	1,863	8,798	1,584	12,420	2,484	7,763	1,319	7,245	1,159
		20	0.28	10,350	2,070	9,315	1,863	8,798	1,584	12,420	2,484	7,763	1,319	7,245	1,159
		25	0.16	9,315	1,677	8,384	1,509	7,918	1,283	11,178	2,012	6,987	1,069	6,521	939
		30	0.16	9,315	1,677	8,384	1,509	7,918	1,283	11,178	2,012	6,987	1,069	6,521	939
		35	0.1	9,315	1,677	8,384	1,509	7,918	1,283	11,178	2,012	6,987	1,069	6,521	939
		40	0.1	9,315	1,677	8,384	1,509	7,918	1,283	11,178	2,012	6,987	1,069	6,521	939
		45	0.08	8,280	1,408	7,452	1,267	7,038	1,076	9,936	1,689	6,210	897	5,796	788
		50	0.07	8,280	1,408	7,452	1,267	7,038	1,076	9,936	1,689	6,210	897	5,796	788
2.5	5	20	0.35	8,100	1,944	7,290	1,750	6,885	1,377	9,720	2,333	6,075	1,215	5,670	1,021
		25	0.35	8,100	1,944	7,290	1,750	6,885	1,377	9,720	2,333	6,075	1,215	5,670	1,021
		30	0.2	7,290	1,750	6,561	1,575	6,197	1,239	8,748	2,100	5,468	1,094	5,103	919
		40	0.2	7,290	1,575	6,561	1,418	6,197	1,115	8,748	1,890	5,468	985	5,103	827

【Note】 Please refer to P.512

Recommended Cutting Datas to General Machining

SPM200-BN2

2 Flute, Extended Neck-Ball Nose End Mill

» continue

Workpiece Materials				P						N		H			
				Carbon Steel, Alloy Steel(180 ~ 250HB)		Alloy Steels, Tool Steels(25 ~ 35HRC)		PH, Ferrite, Martensite Steels(35 ~ 45HRC)		Copper, Copper Alloys		Hardened Steels (45 ~ 55HRC)		Hardened Steels (55 ~ 65HRC)	
Ratio to standard depth of cut(ap)				1.00		0.90		0.70		1.20		0.50		0.45	
R (mm)	Mill Dia. (mm)	Under Neck Length (mm)	ap	n r/min	Vf mm/min	n r/min	Vf mm/min	n r/min	Vf mm/min	n r/min	Vf mm/min	n r/min	Vf mm/min	n r/min	Vf mm/min
3	6	12	0.6	8,100	2,268	7,290	2,041	6,885	1,701	9,720	2,722	6,075	1,383	5,670	1,134
		20	0.5	7,650	1,989	6,885	1,790	6,503	1,492	9,180	2,387	5,738	1,213	5,355	995
		30	0.42	7,200	1,728	6,480	1,555	6,120	1,224	8,640	2,074	5,400	1,080	5,040	907
		50	0.15	6,480	1,400	5,832	1,260	5,508	992	7,776	1,679	4,860	875	4,536	734

【Note】

- For different materials, adjust the cutting depth (ap) according to the cutting depth factors in the above table. E.g. for hardened steels (45 ~ 55HRC), ap*0.5.
- When performing cutting where cutting chips may cause clogging, such as for rib cutting, blind grooves, etc., cutting depth setting should be set by multiplying a cutting depth factor to calculate the cutting depth amount, and this amount should then be reduced to 80% of the calculated value.
- Adjust by setting ae to (3 to 5)×(ap)×(cutting depth ratio). When performing finishing processing, calculate the theoretical cusp height and set accordingly.
- Use the appropriate coolant such as air cooling or emulsion for the work material and machining shape.
- In actual machining, the condition should be adjusted according to the machining shape, purpose and the machine type.



APPENDIX



Cutting Parameters and General Formula

Parameter and Unit		
D Diameter	(mm)	F _n Feed per Revolution (mm/rev)
a _p Cutting Depth	(mm)	f _z Feeding per Teeth (mm/tooth)
a _e Cutting Depth	(mm)	Z Number of Teeth
V _f Feed Rate	(mm/min)	n Spindle Speed (rev/min)
V _c Cutting Speed (I+D)	(m/min)	L Length (mm)
Q Rate of Metal Removal	(cm ³ /min)	T _c Processing Time (min)

General Formula	
n Spindle Speed	$n = \frac{V_c \cdot 1000}{\pi \cdot D} \text{ (rev/min)}$
V _c Cutting Speed	$V_c = \frac{\pi \cdot D \cdot n}{1000} \text{ (m/min)}$
V _f Feed Rate	$V_f = f_z \cdot z \cdot n \text{ (mm/min)}$
f _z Feed per Teeth	$f_z = \frac{V_f}{z \cdot n} \text{ (mm)}$
Q Rate of Metal Removal	$Q = \frac{a_e \cdot a_p \cdot V_f}{1000} \text{ (cm}^3\text{/min)}$
T _c Processing Time	$T_c = \frac{L}{V_f} \text{ (min)}$

Workpiece Material Table

ISO Material Group MC GESAC	MC	Workpiece Material	Carbon Content	Tensile Strength N/mm ²	Brinell Hardness HB	Rockwell Hardness HRC
P Steels	P1	Low-carbon Steels, Long Chipping.	C<0.25%	<530	<125	
	P2	Low-carbon Steels, Short Chipping, Free-cutting Steels	C<0.25%	<530	<125	
	P3	High-carbon Steels, Medium-carbon Steels.	C>0.25%	>530	<220	<25
	P4	Alloy Steels, Tool Steels.	C>0.25%	600-850	<330	<35
	P5	Alloy Steels, Tool Steels.	C>0.25%	850-1400	340-450	35-48
	P6	Ferritic Stainless Steels, Martensitic Stainless Steels, PH Stainless Steels.	C=(0-0.4)%	600-900	<330	<35
	P7	High-strength Ferritic Stainless Steels, Martensitic Stainless Steels, PH Stainless Steels.	C=(0.1-0.6)%	900-1350	330-450	35-48
M Stainless Steels	M1	Austenitic Stainless Steels.	C=(0.05-0.15)%	<600	130-200	
	M2	High-Strength Austenitic Stainless Steels and Cast Stainless Steels.	C=(0.05-0.15)%	600-800	150-230	<25
	M3	Duplex Stainless Steels.	C=(0.05-0.20)%	<800	135-275	<30
K Cast Iron	K1	Grey Cast Iron.		125-500	120-290	< 32
	K2	Moderately Difficult Alloy Cast Iron, Nodular Cast Iron.		<600	130-260	< 28
	K3	Difficult High-alloy Cast Iron, Nodular Cast Iron.		>600	180-350	< 43
N Non-ferrous Materials	N1	Wrought Aluminium Alloys.		<520	60-90	
	N2	Wrought Aluminium Alloys.	Si<12%	<350	70-100	
	N3	Wrought Aluminium Alloys.	Si>12%	200-320	60-120	
	N4	Copper, Copper Alloys.		200-650	60-200	
	N5	Graphite, CFK, CFRP Graphite, Composite Materials.		600-1500		
	N6	GFK, CFK Aluminium-based Composite Materials.		<700	<210	
S Heat-resistant Alloys and Titanium Alloys	S1	Iron-based Heat-resistant Alloys.		500-1200	160-260	25-48
	S2	Cobalt-based Heat-resistant Alloys.		1000-1450	250-450	25-48
	S3	Nickel-based Heat-resistant Alloys.		600-1700	160-450	<48
	S4	Titanium and Titanium Alloys.		900-1600	300-400	33-48
H High Hardness Materials	H1	Hardened Steels.				45-55
	H2	Hardened Steels.				55-60
	H3	Hardened Steels.				60-65
	H4	Hardened Steels.				>65

The Structure of Shank-DIN Standard

DIN 6535-HA



d, h ₆	2	3	4	5	6	8	10	12	14	16	18	20	25	32
l_{+2}^0	28				36		40		45		48		60	

DIN 6535-HB

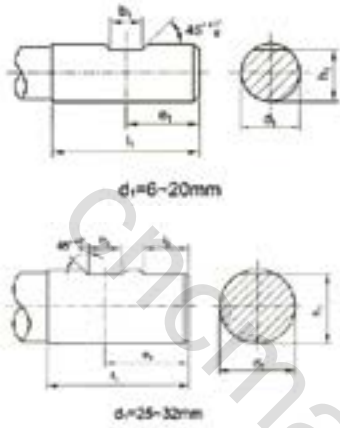

d_1 h_6	b_1 $+0.05$ 0	e_1 0 -1	h_1 h_{11}	l_1 $+2$ 0	l_2 $+1$ 0
6.0	4.2	18.0	5.1	36.0	
8.0	5.5		6.9		
10	7.0	20.0	8.5	40.0	
12	8.0	22.5	10.4	45.0	
14			12.7		
16	10.0	24.0	14.2	48.0	
18			16.2		
20	11.0	25.0	18.2	50.0	
25	12.0	32.0	23.0	56.0	17.0
32	14.0	36.0	30.0	60.0	19.0

DIN 6535-HE

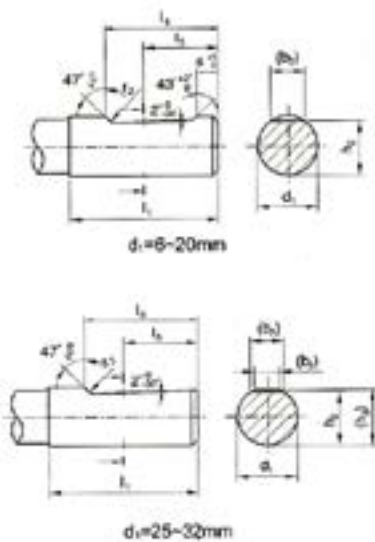

d_1	(b_2)	(b_3)	(h_2)	(h_3)	l_1	l_4	l_5	r_2
6.0	4.3		5.1		36.0	25.0	18.0	1.2
8.0	5.5		6.9					
10	7.1		8.5		40.0	28.0	20.0	
12	8.2		10.4		45.0	33.0	22.5	
14	8.1		12.7		48.0	36.0	24.0	
16	10.1		14.2					
18	10.8	16.2	50.0	38.0	25.0	1.6		
20	11.4	18.2						
25	13.6	9.3	23.0	24.1	56.0		44.0	32.0
32	15.5	9.9	30.0	31.2	60.0		48.0	35.0

Comparison Table for Tensile Strength, Vickers Hardness, Brinell Hardness and Rockwell Hardness

N/mm2	HV10	HB	HRC	N/mm2	HV10	HB	HRC
240	75	71		920	287	273	28
255	80	76		940	293	278	29
270	85	81		970	302	287	30
285	90	86		995	310	295	31
305	95	90		1020	317	301	32
320	100	95		1050	327	311	33
335	105	100		1080	336	319	34
350	110	105		1110	345	328	35
370	115	109		1140	355	337	36
385	120	114		1170	364	346	37
400	125	119		1200	373	354	38
415	130	124		1230	382	363	39
430	135	128		1260	392	372	40
450	140	133		1260	403	383	41
465	145	138		1330	413	393	42
480	150	143		1360	423	402	43
495	155	147		1400	434	413	44
510	160	152		1440	446	424	45
530	165	157		1480	458	435	46
545	170	162		1530	473	449	47
560	175	166		1570	484	460	48
575	180	171		1620	497	472	49
595	185	176		1680	514	488	50
610	190	181		1730	527	501	51
625	195	185		1790	544	517	52
640	200	190		1845	560	632	53
660	205	195		1910	578	549	54
675	210	199		1980	596	567	55
690	215	204		2050	615	584	56
705	220	209		2140	639	607	57
720	225	214			655	622	58
740	230	219			675		59
755	235	223			698		60
770	240	228			720		61
785	245	233			745		62
800	250	238	22		773		63
820	255	242	23		800		64
835	260	247	24		829		65
860	268	255	25		864		66
870	272	258	26		900		67
900	280	266	27		940		68



ООО "СИЭНСИЭМ Групп"

Адрес: РФ, Алтайский край, г. Барнаул, ул.
Взлётная, 35
Тел: +7-913 220-04-43
+7 3852 58-25-72
8 800 250-61-44 (звонок по РФ бесплатно)
Индекс: 656058
Email: sales@cncmagazine.ru
<https://www.cncmagazine.ru>



8 800 250-61-44